

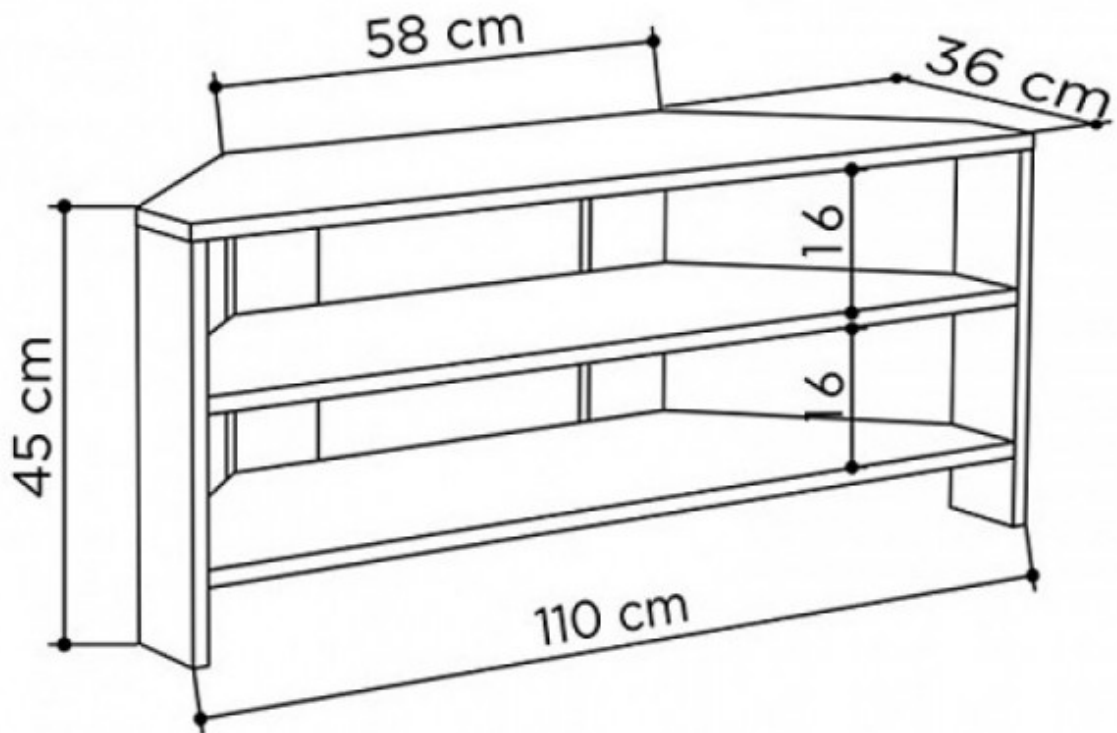

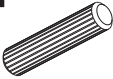

i GP037-0173,3



A04  12x	A06 18mm  C1-24x	A12 Allen  1x	A22 Minifix k18  24x	A23 Minifix M10  24x
PB01 Kece  4x				

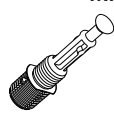
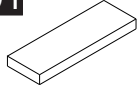
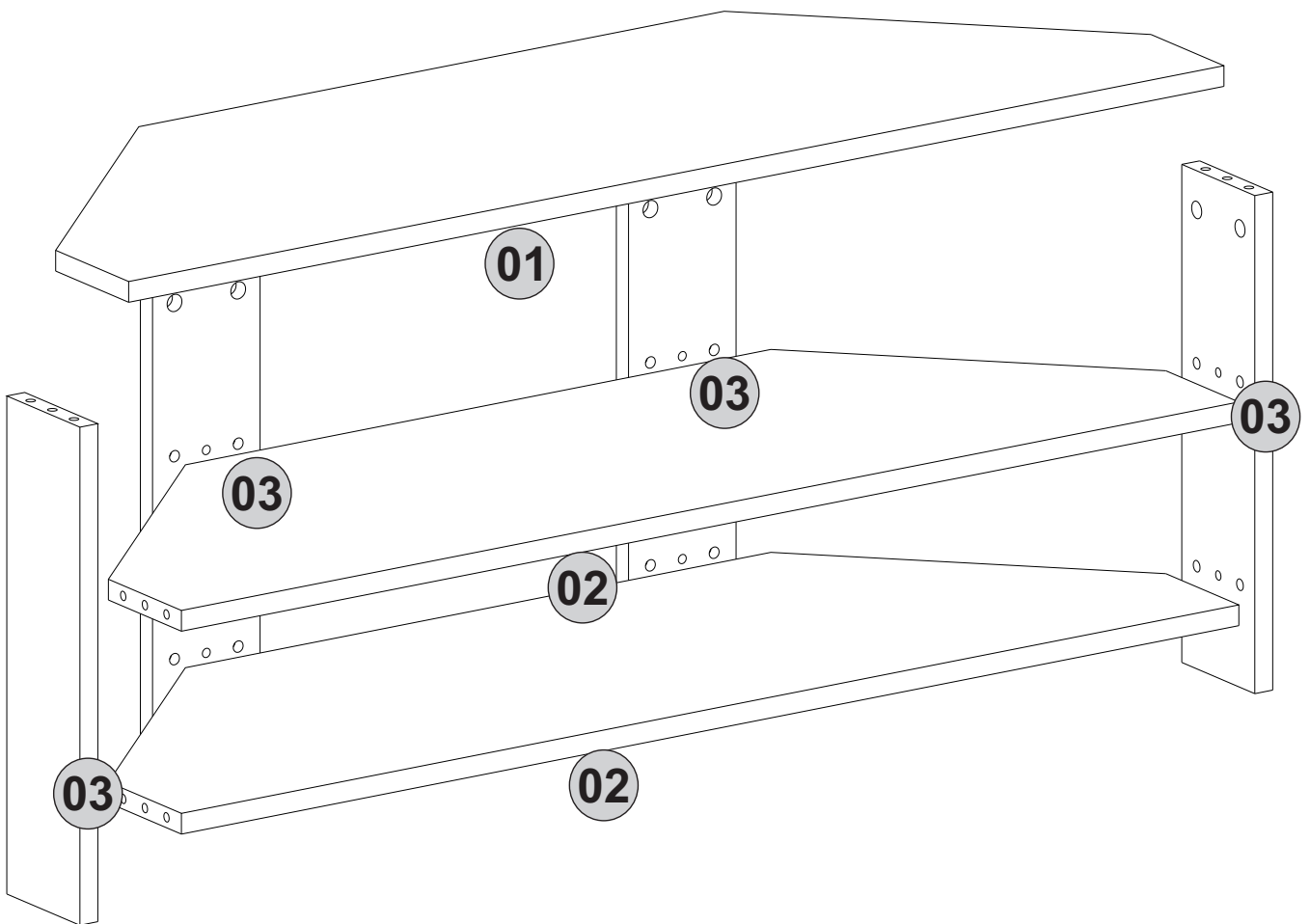

1. step

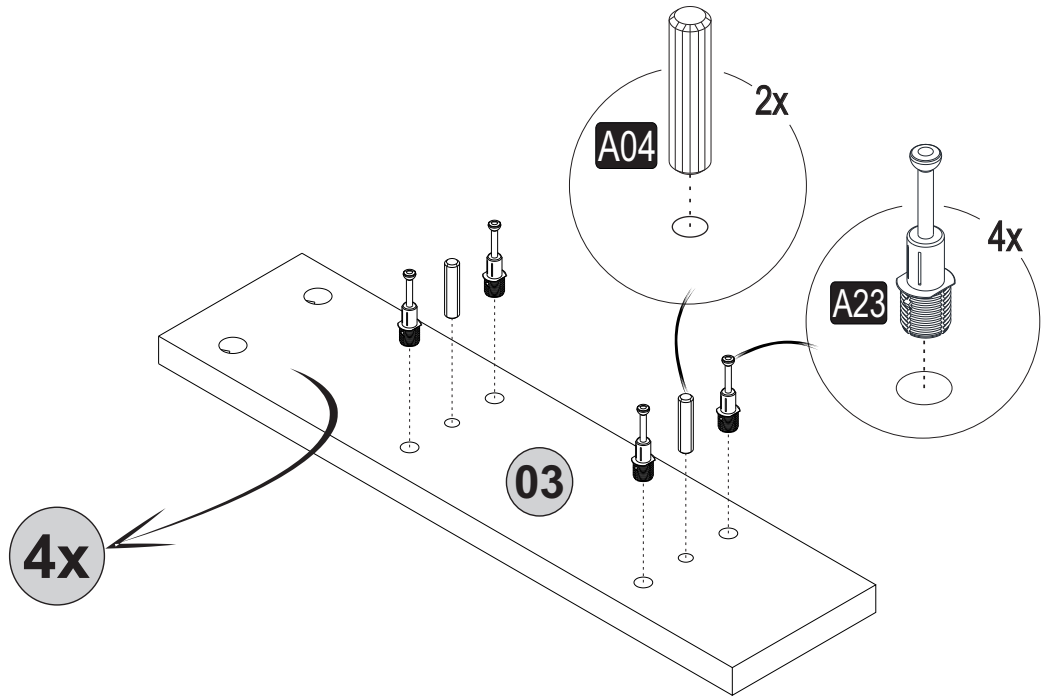

2. step

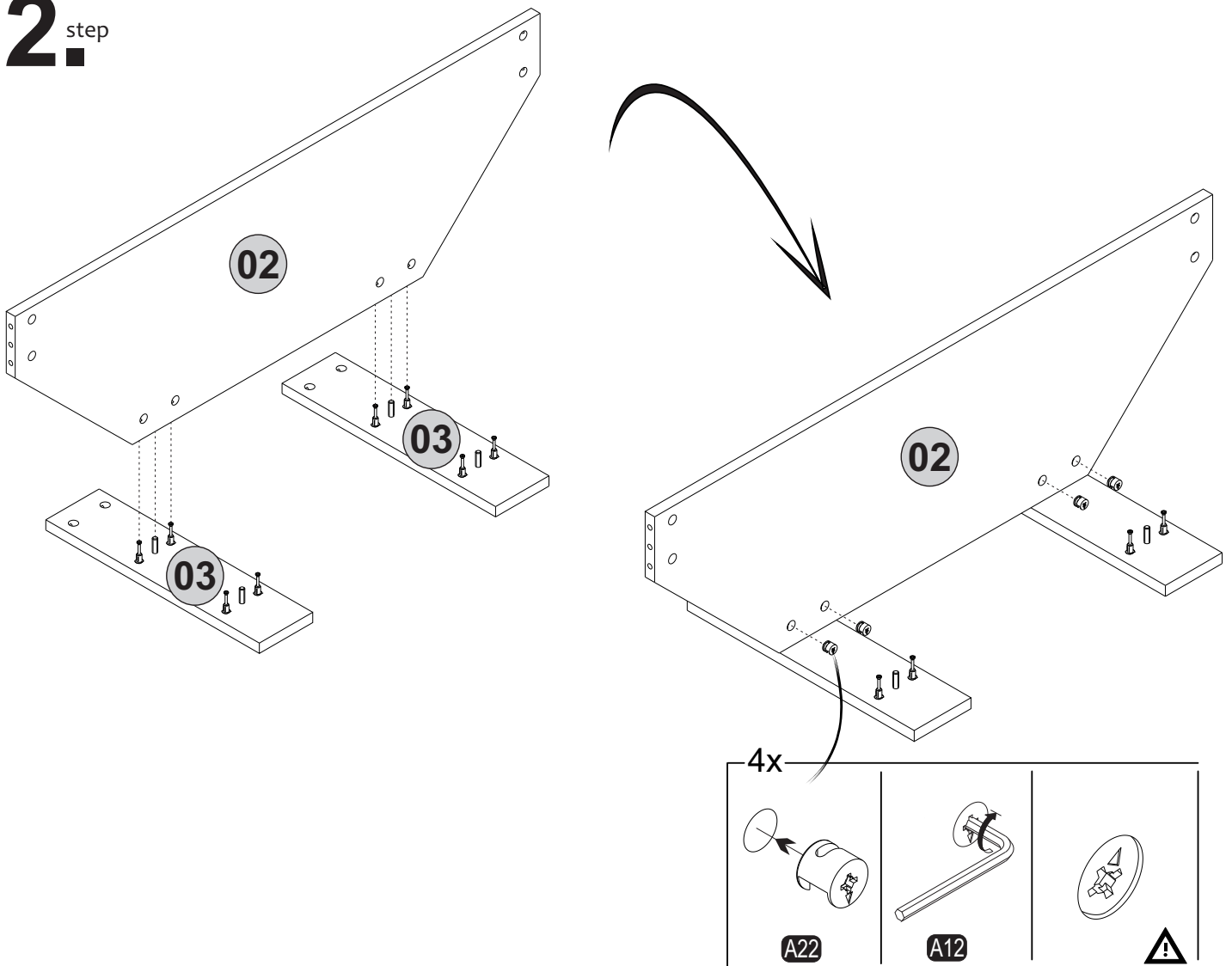

3_{step}

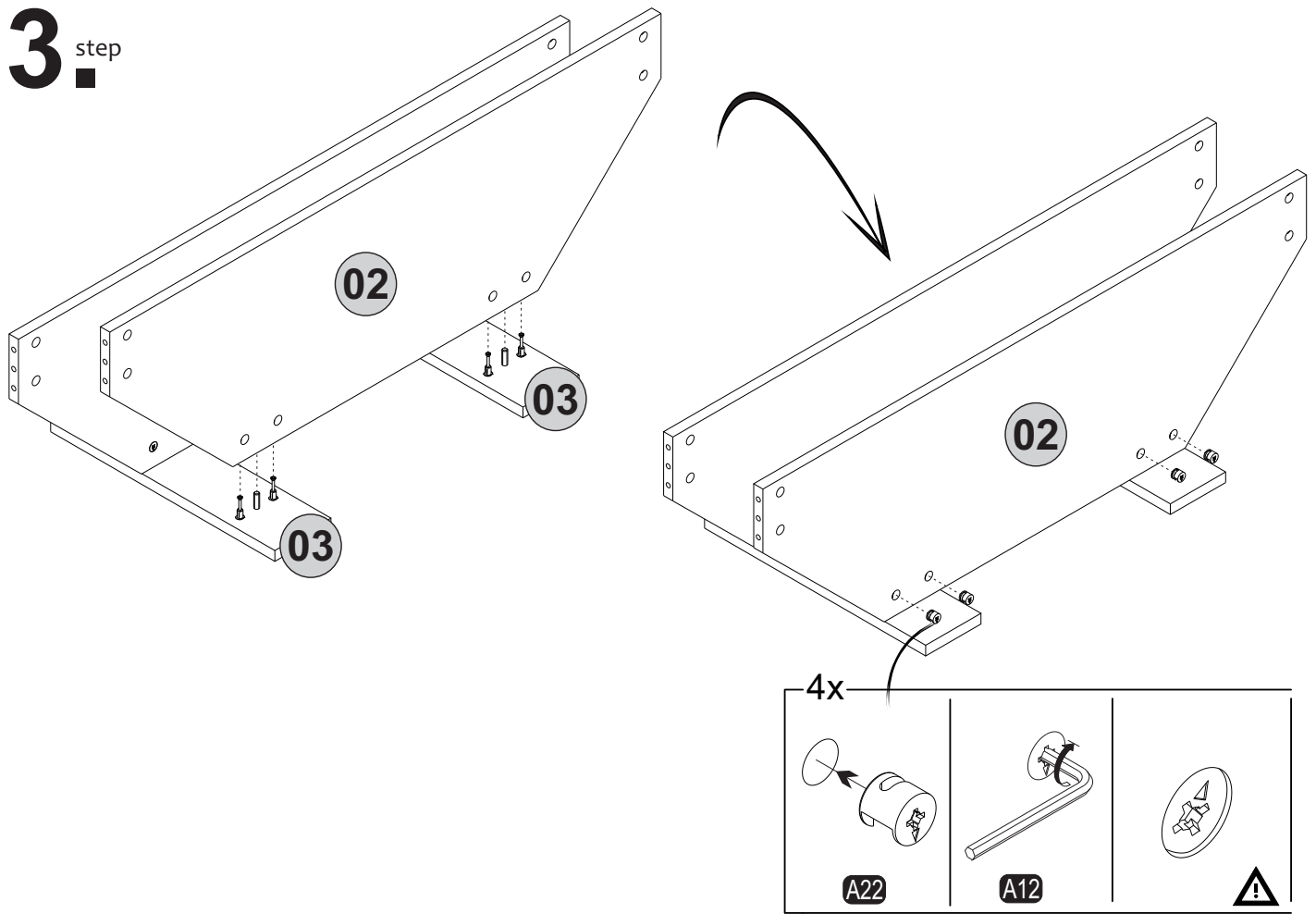

4_{step}

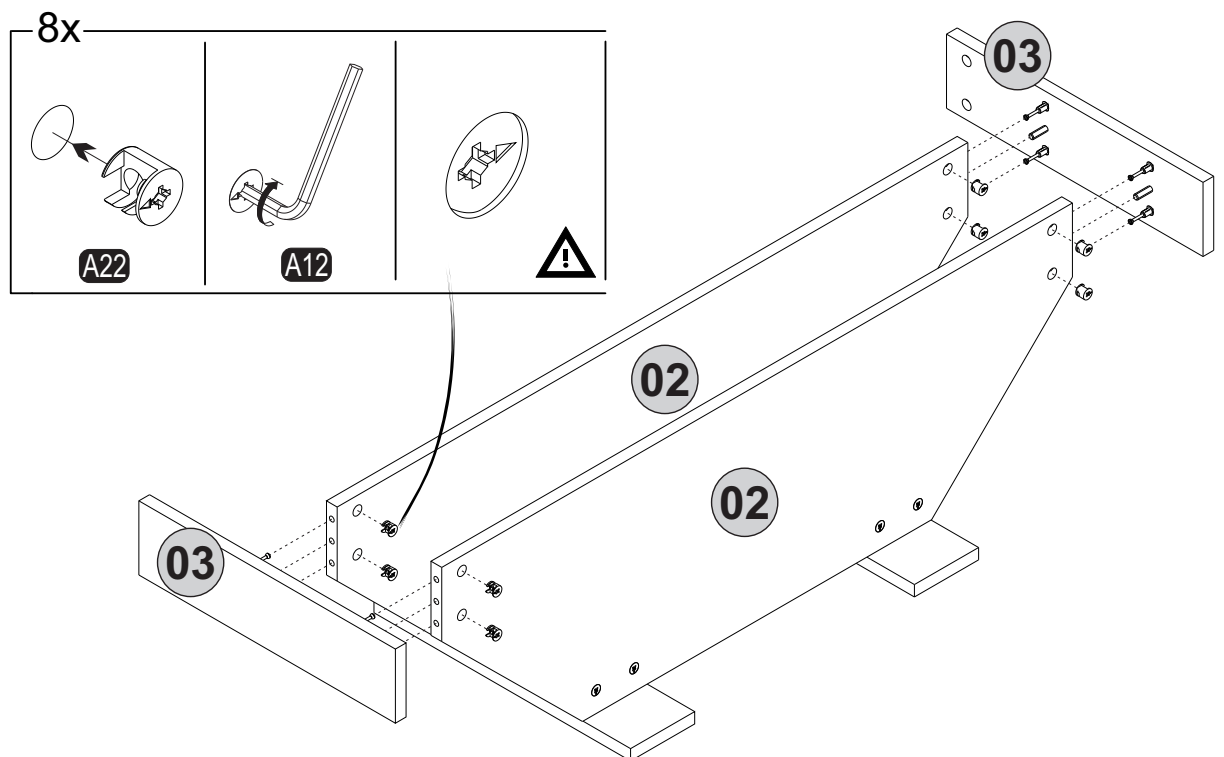

5._{step}

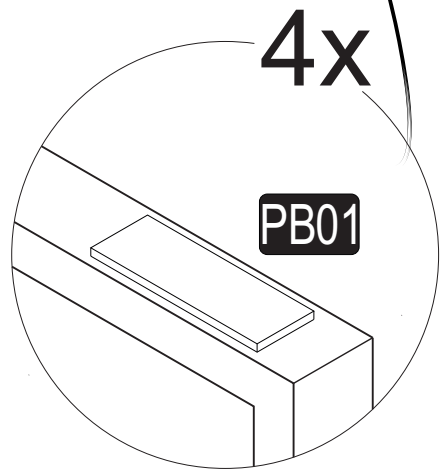
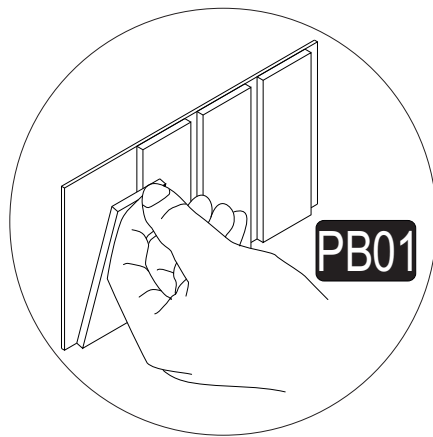
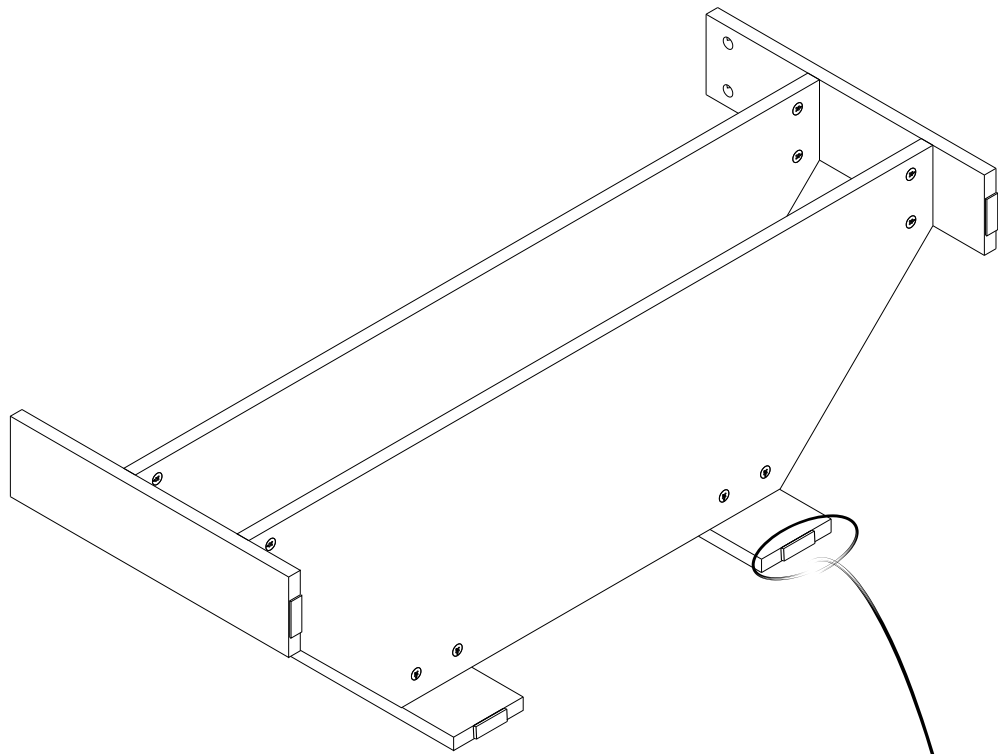

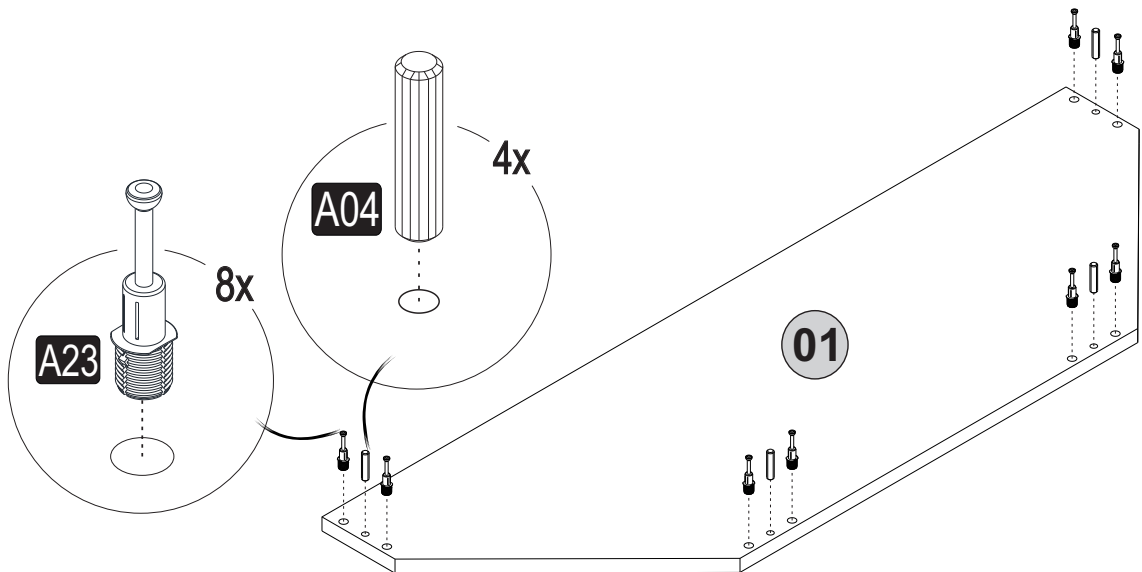

6._{step}

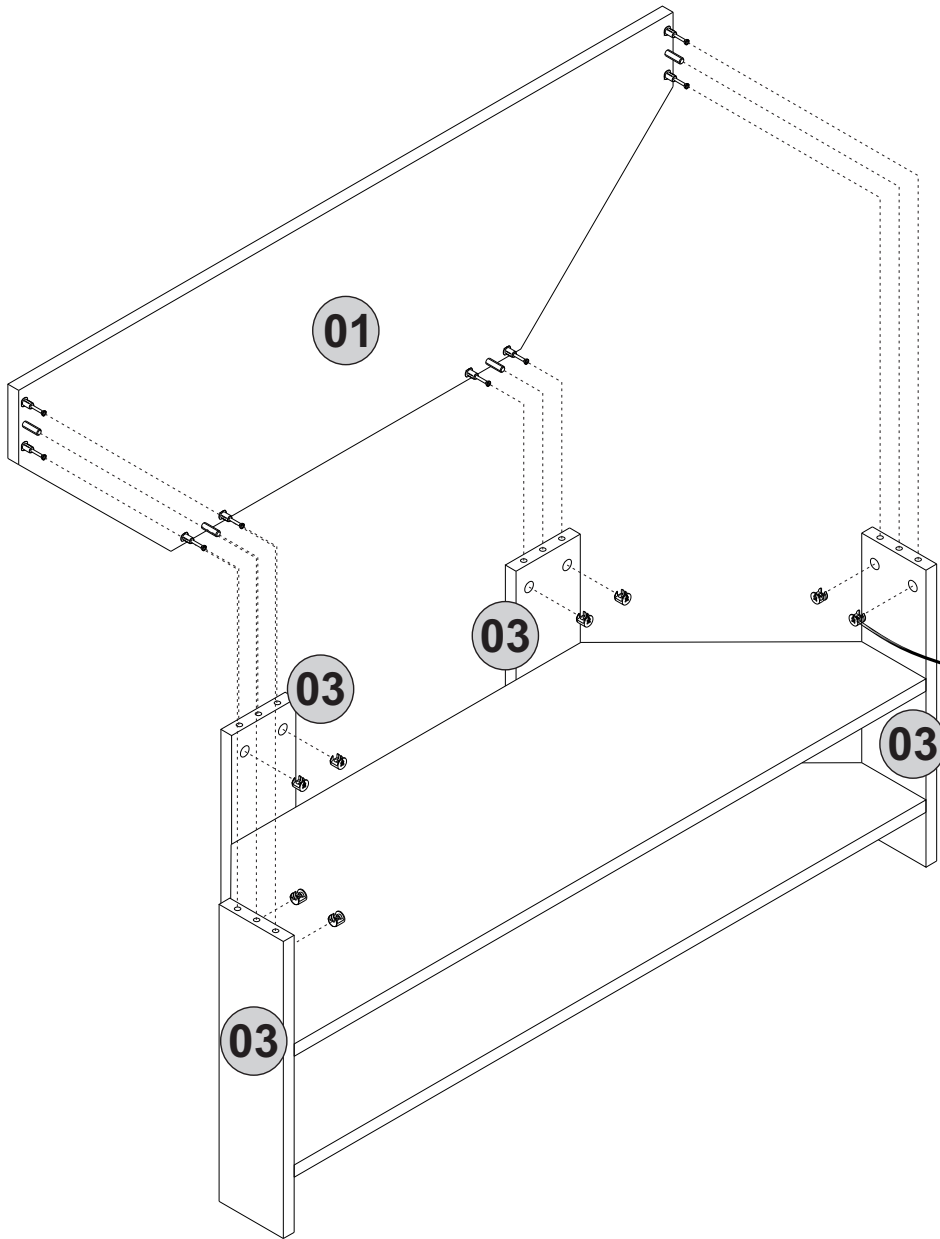

7^{step}

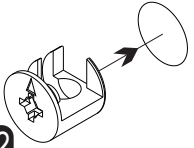
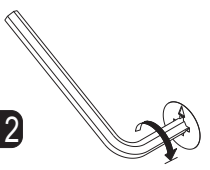

8x

 A22
 A12

8^{step}

