

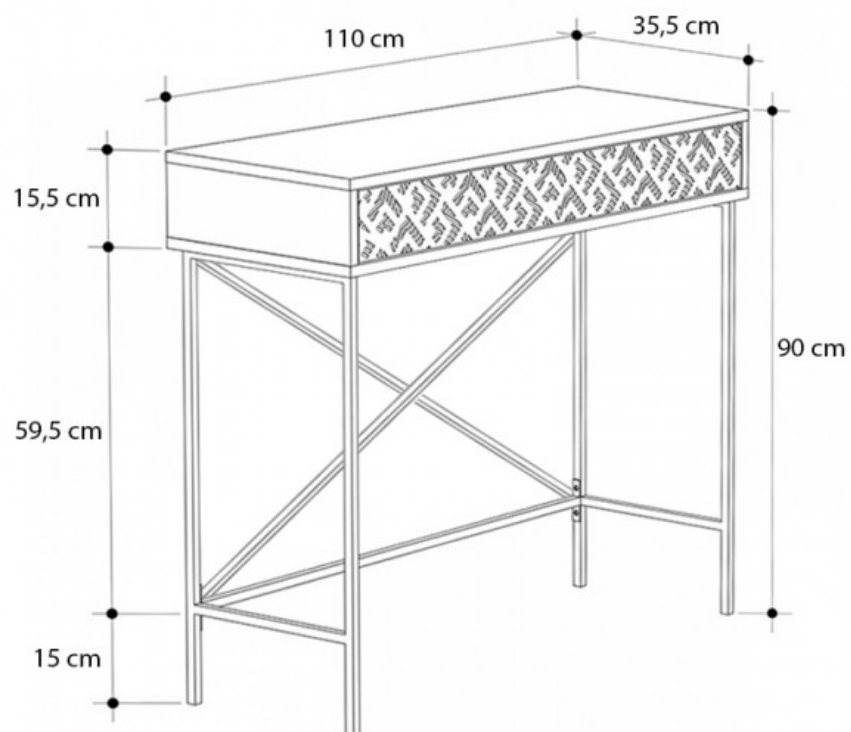









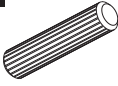
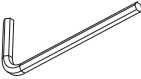



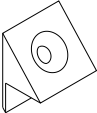
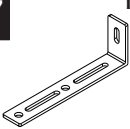

**GP037-0191,4**

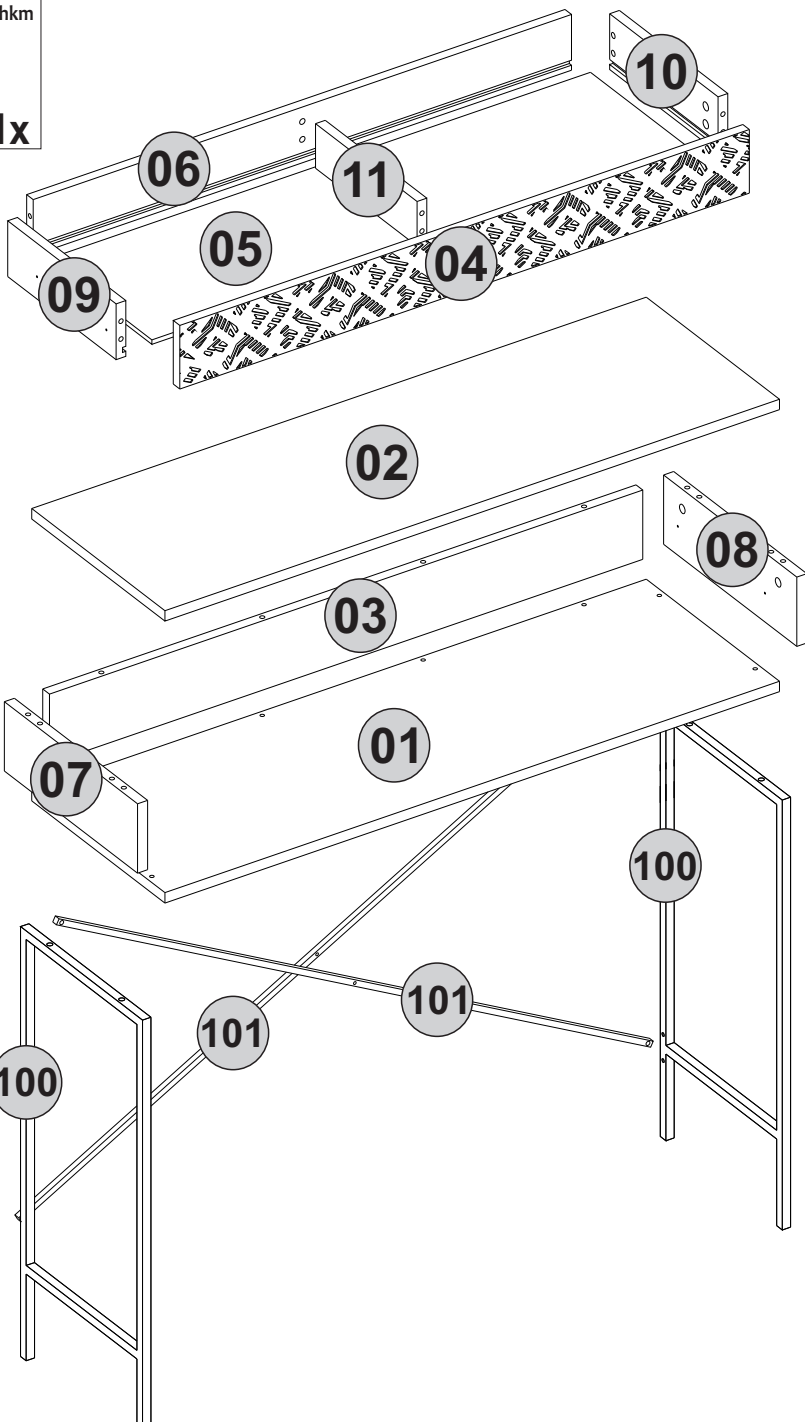

<b>A22</b> Minifix k18  20x	<b>A23</b> Minifix M10  20x	<b>A04</b> Ø8  4x	<b>A12</b> Allen  1x	<b>A06</b> 18mm  C1-28x
<b>A13</b> 50mm  8x	<b>A69</b> P.D.  4x	<b>B13</b> 25 (black)mm  4x	<b>B15</b> 15 (black)mm  4x	<b>A18</b> 3,5x18  8x
<b>A25</b> ARK.PL  6x	<b>A87</b> 15x90x30  1x	<b>A17</b> 4x50  1x	<b>A16</b> DbØ8  1x	<b>Z21</b> 15x15x18  4x
<b>Z122</b> hkm  1x				<b>A50</b> 3,5x16 (Black)  2x
				<b>Z51</b> K128mm (black)  1x

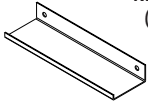
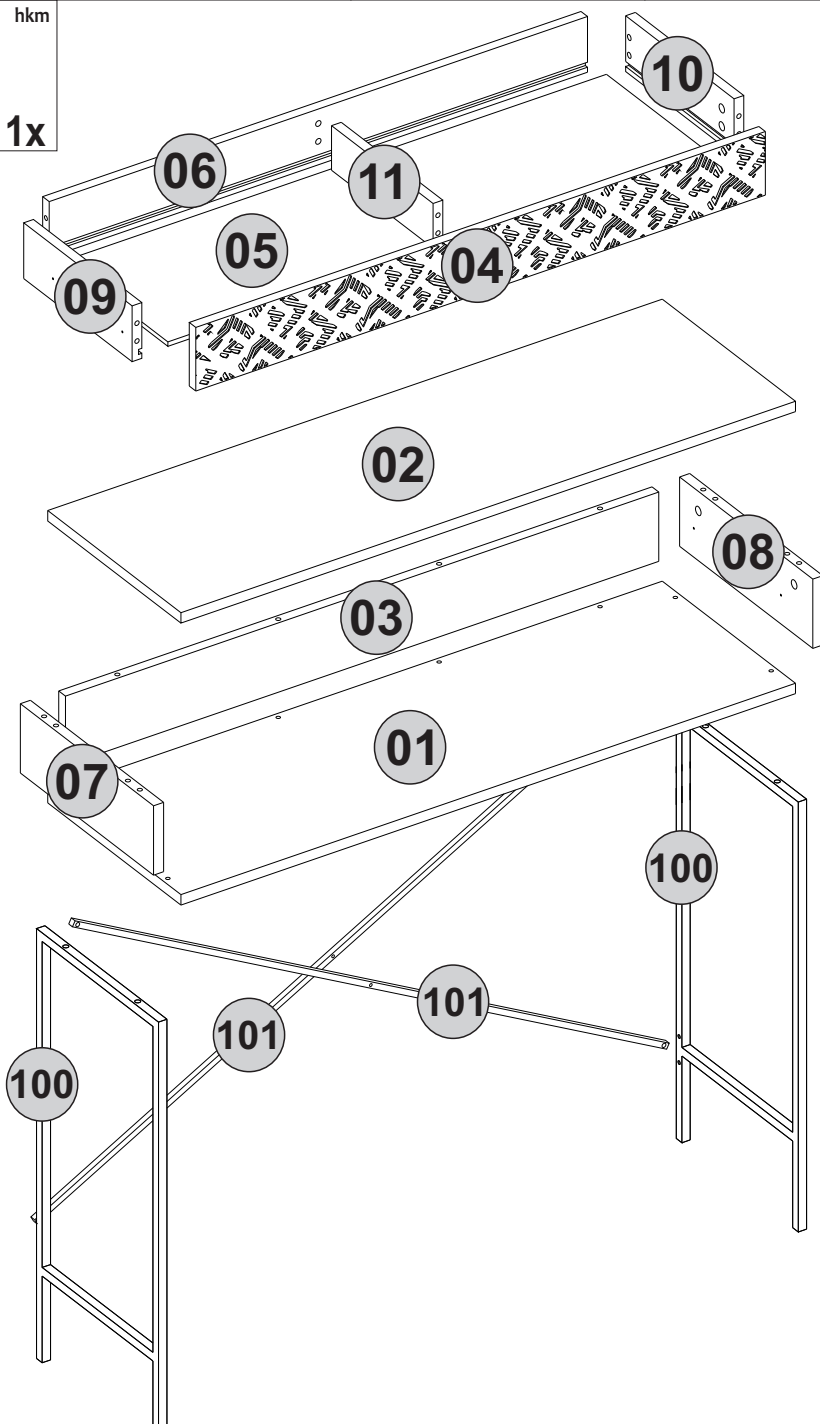

**1.** step

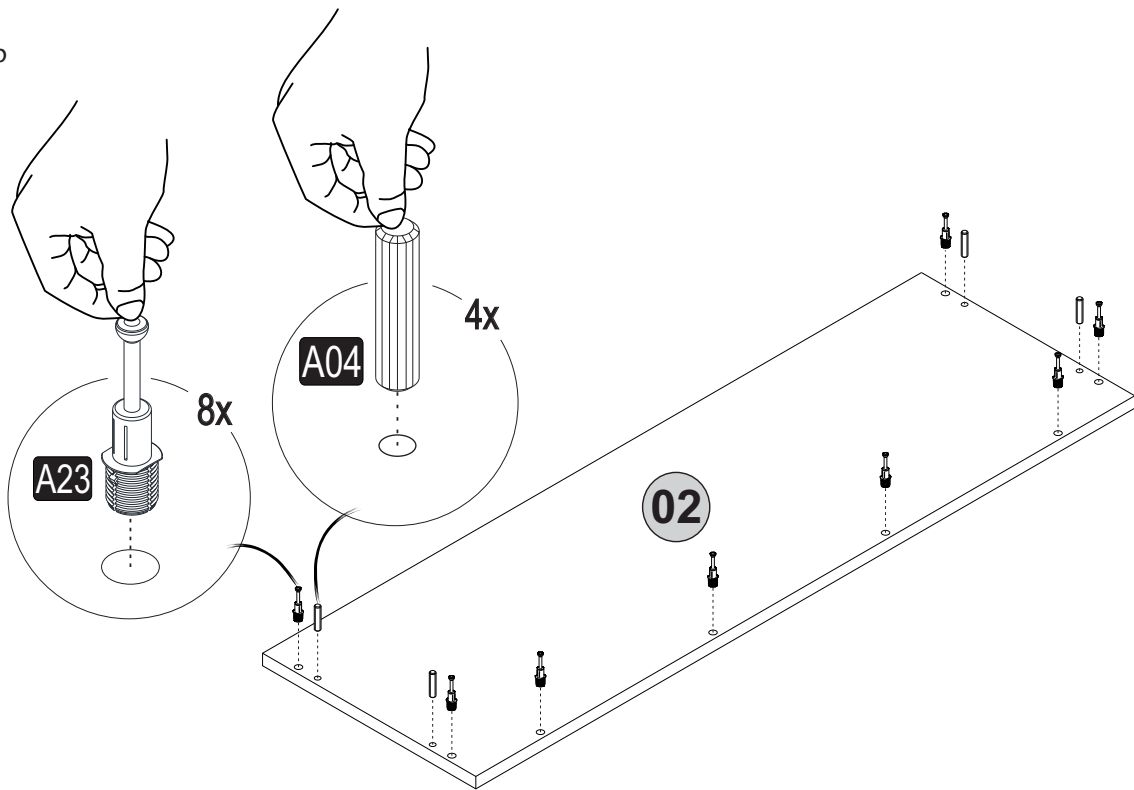

**2.** step

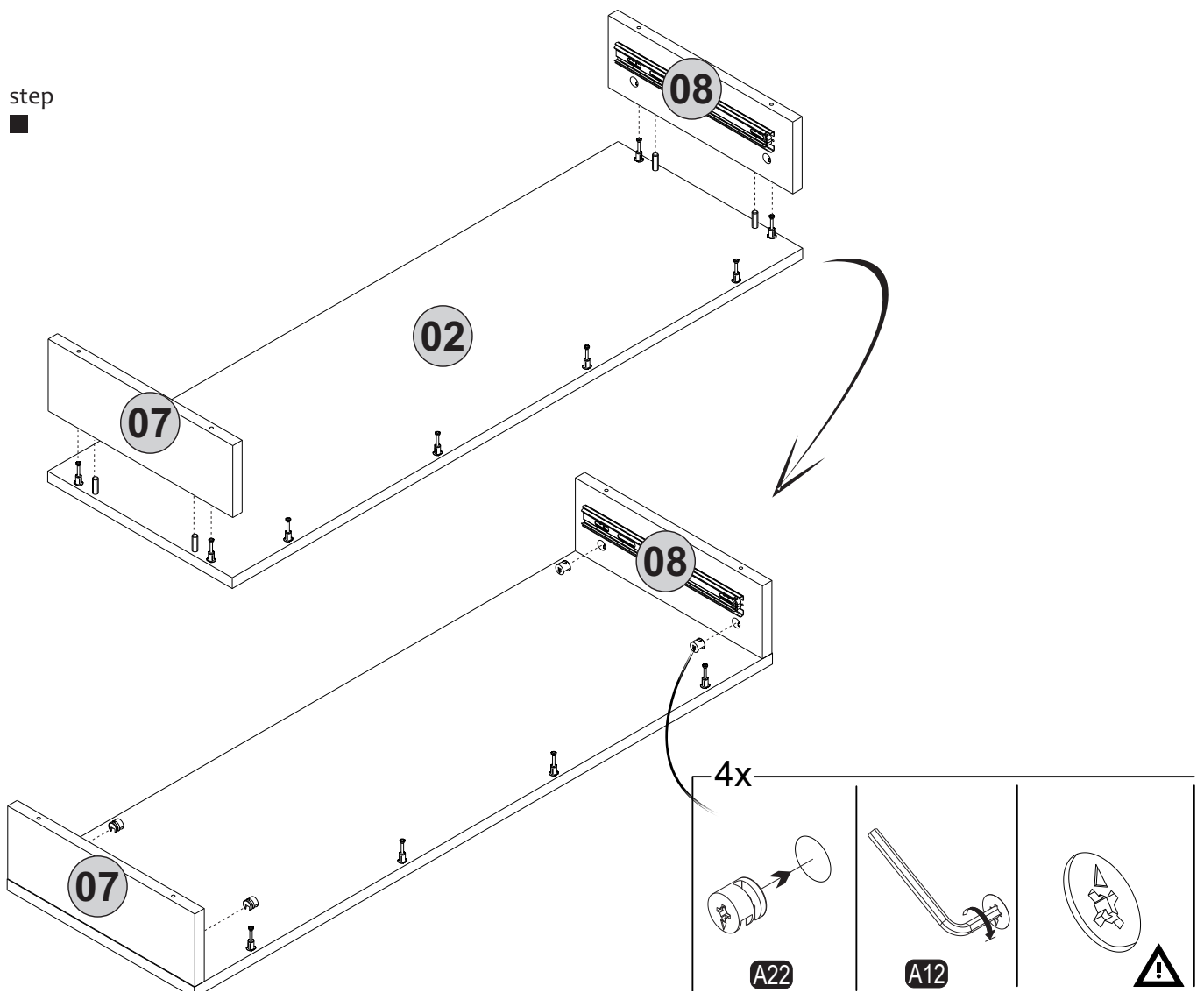

# 3<sup>step</sup>

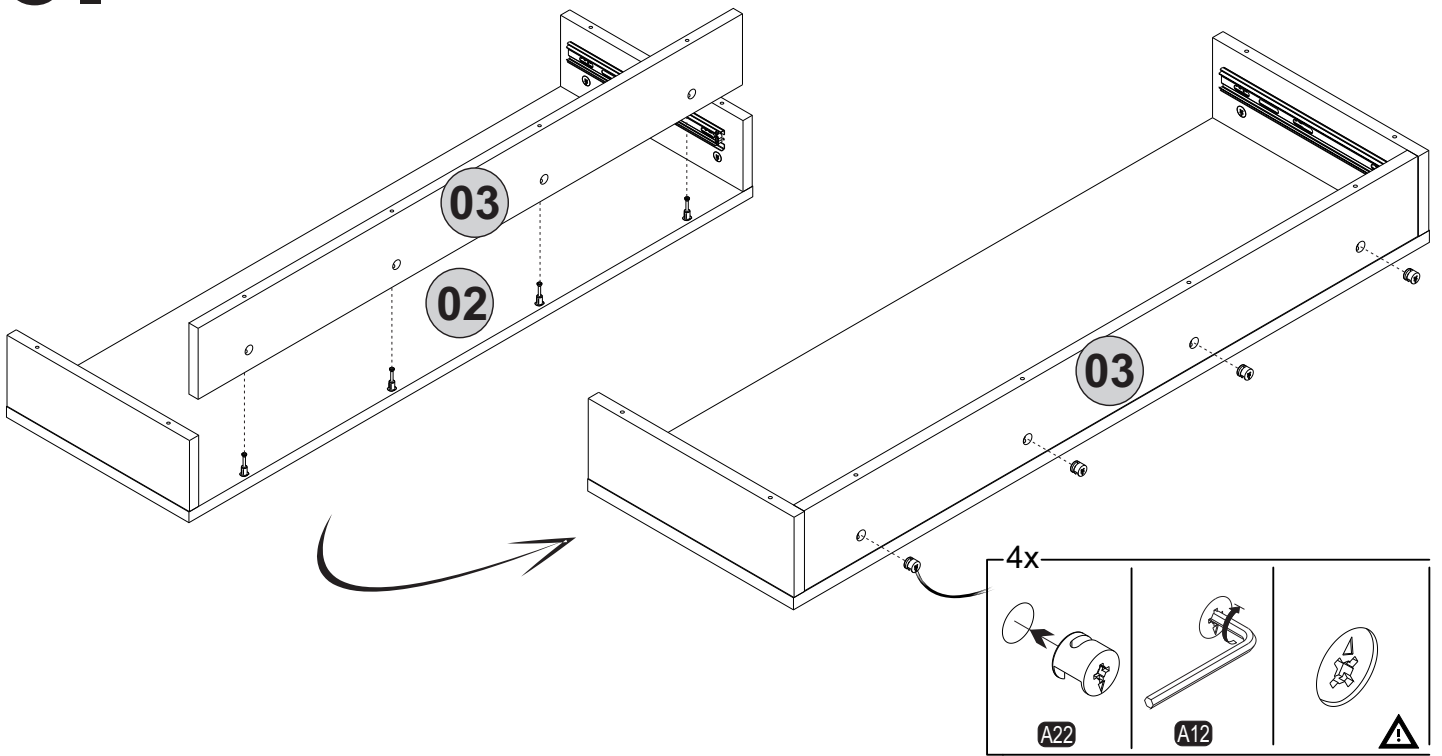

# 4<sup>step</sup>

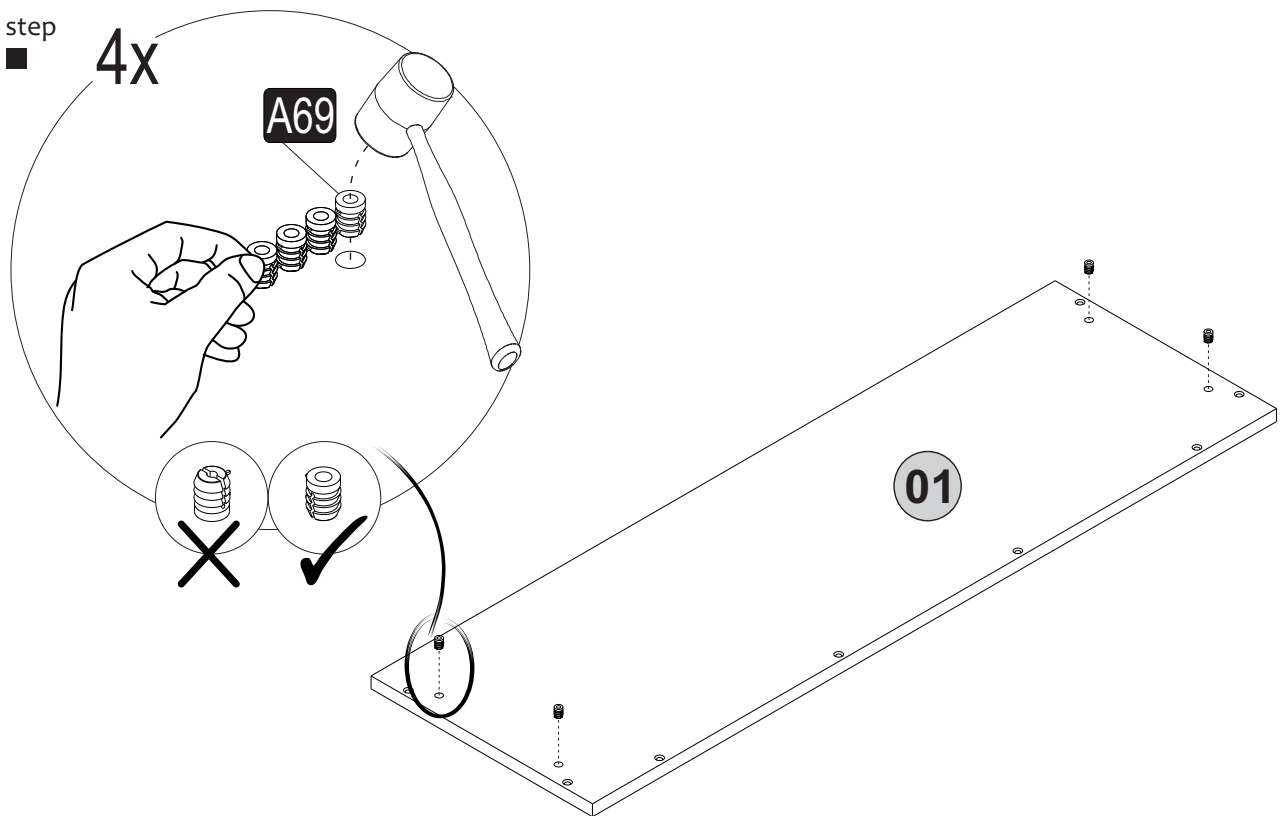

# 5<sup>step</sup>

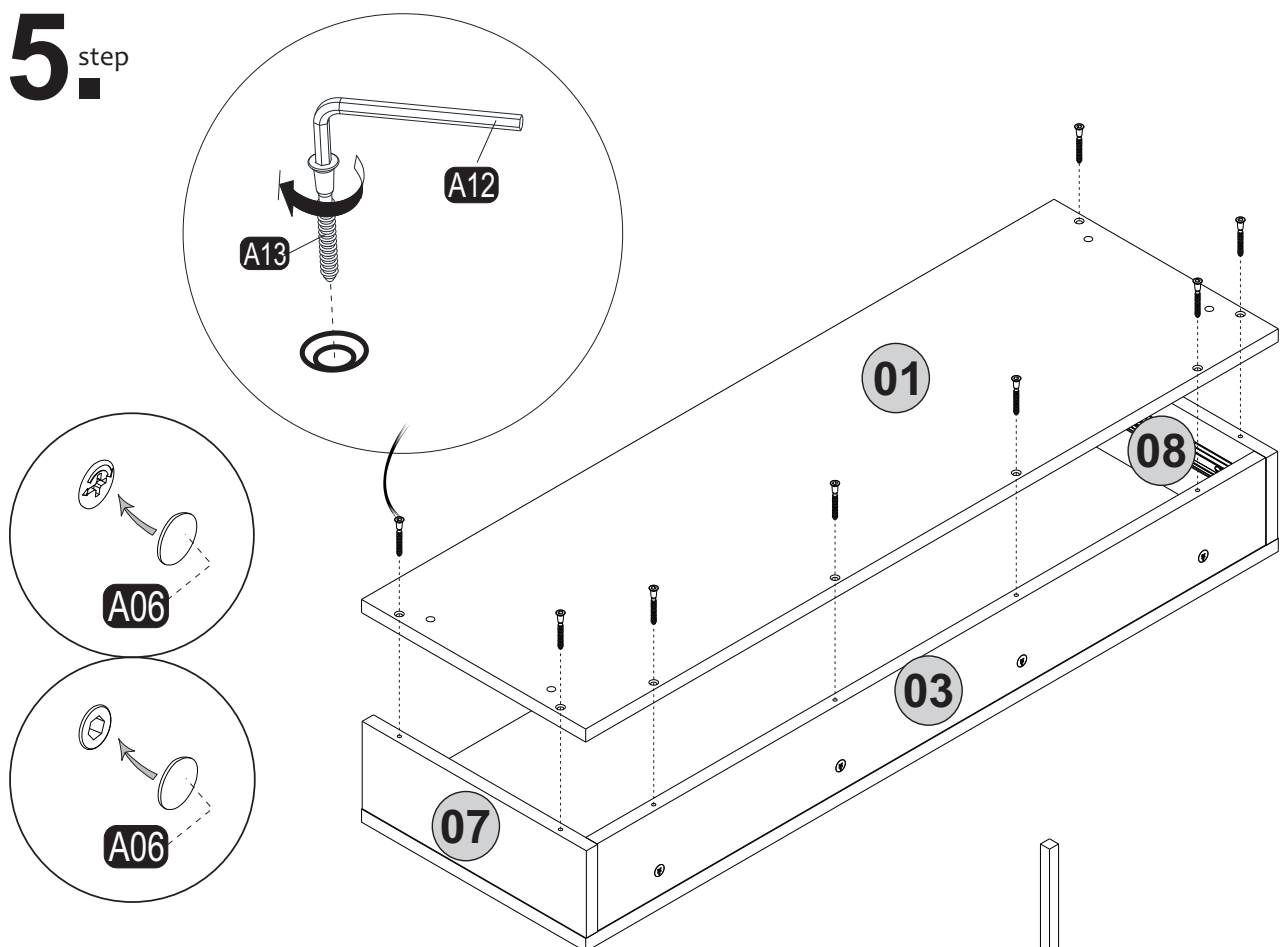

# 6<sup>step</sup>

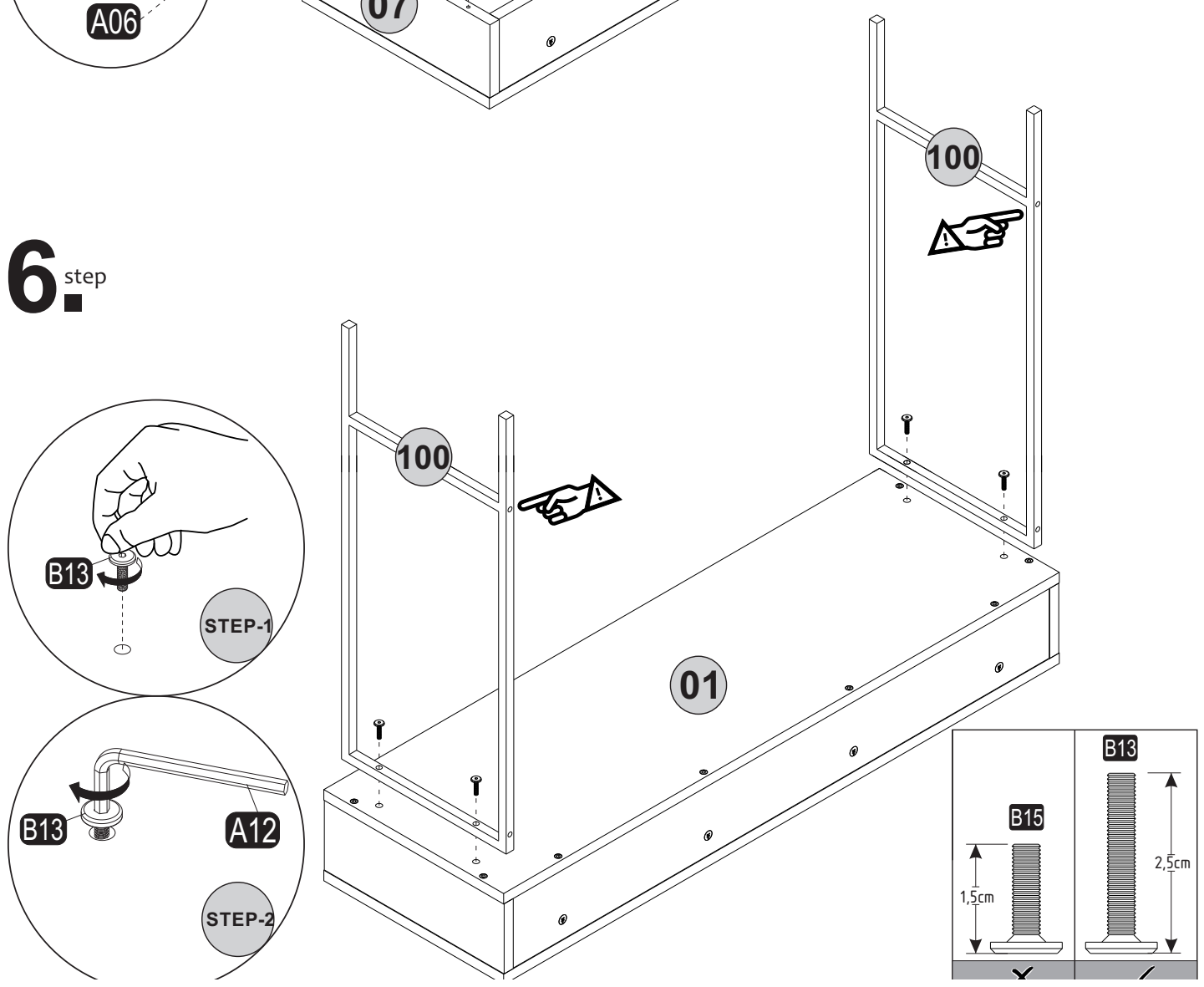

# 7. step

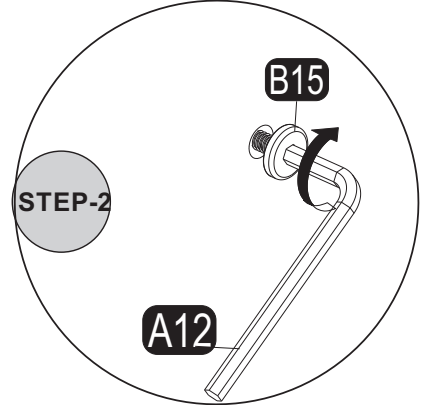
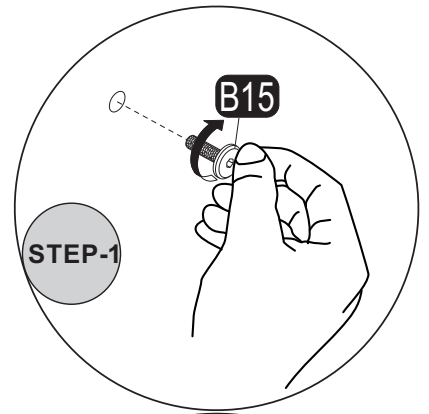
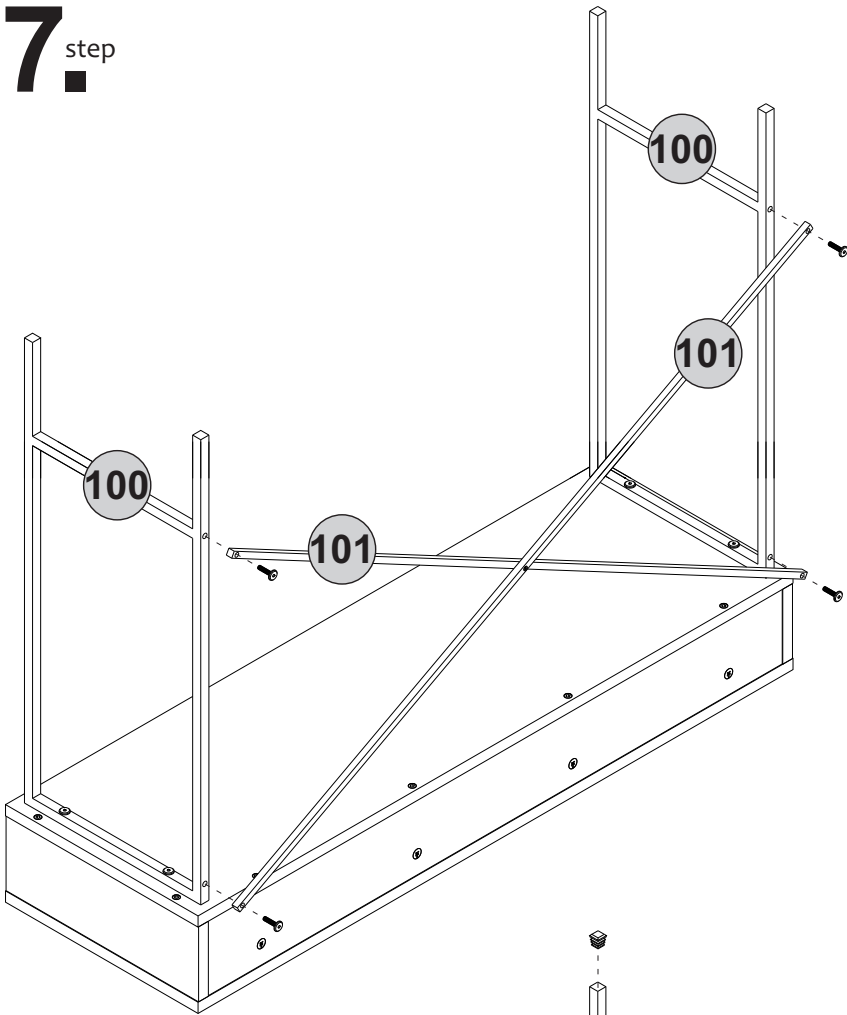

# 8. step

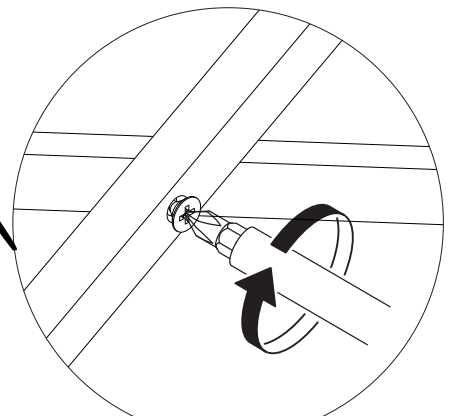
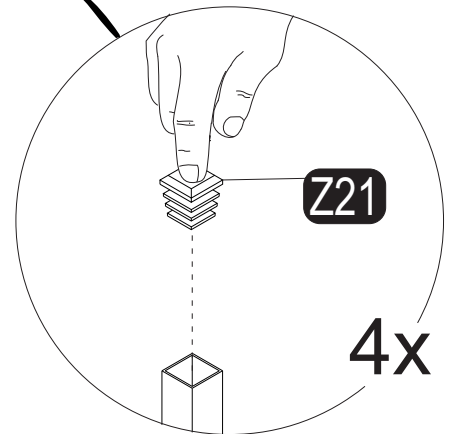
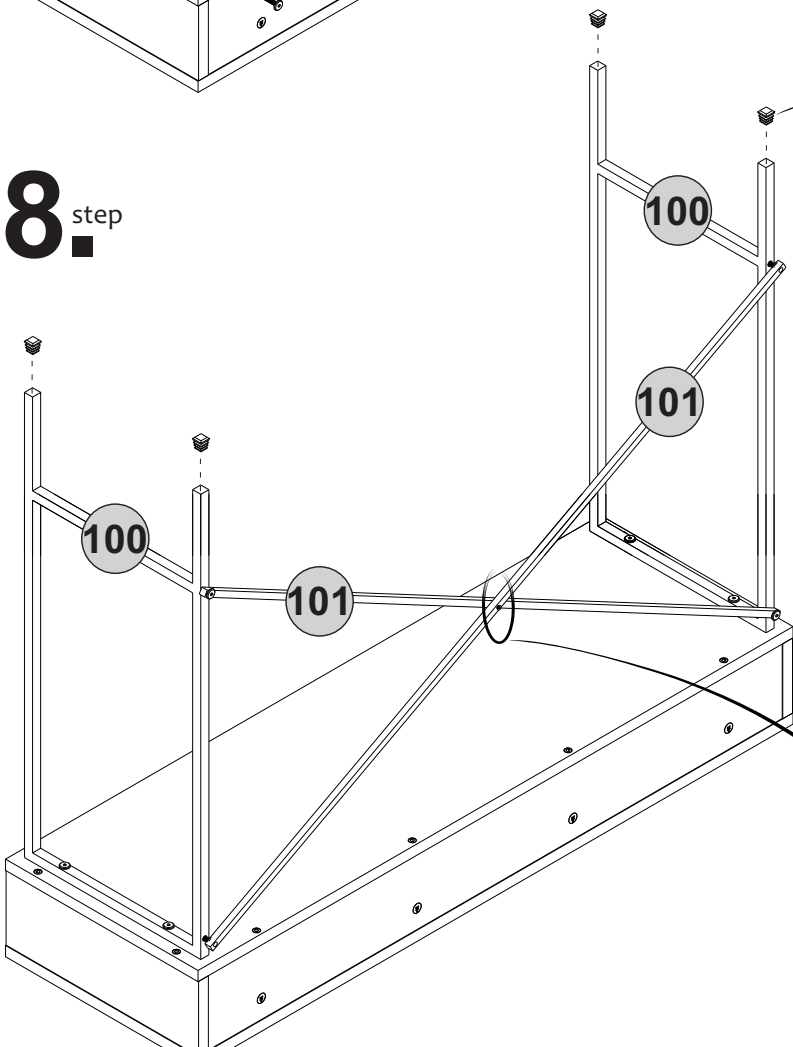

# 9<sup>step</sup>

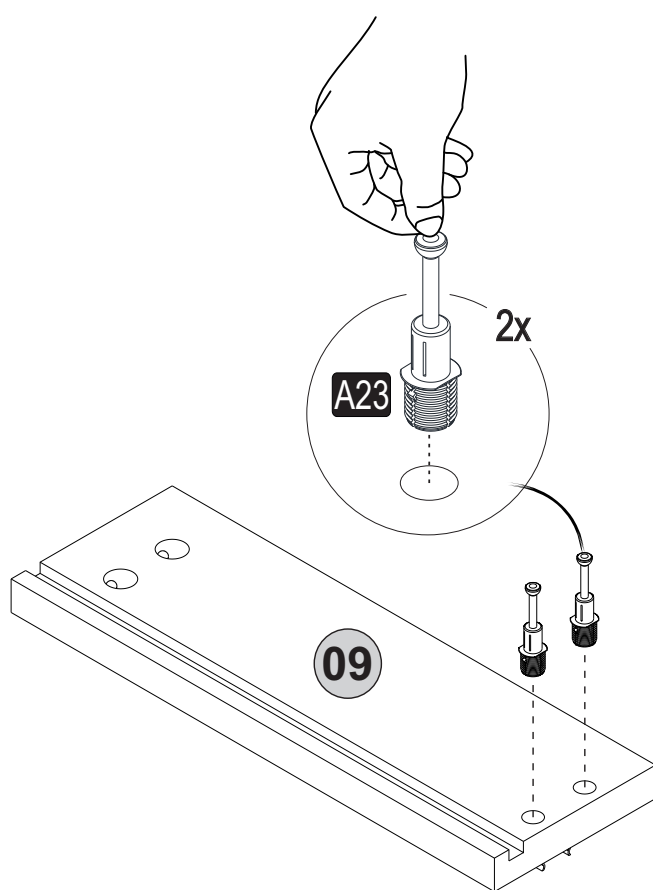
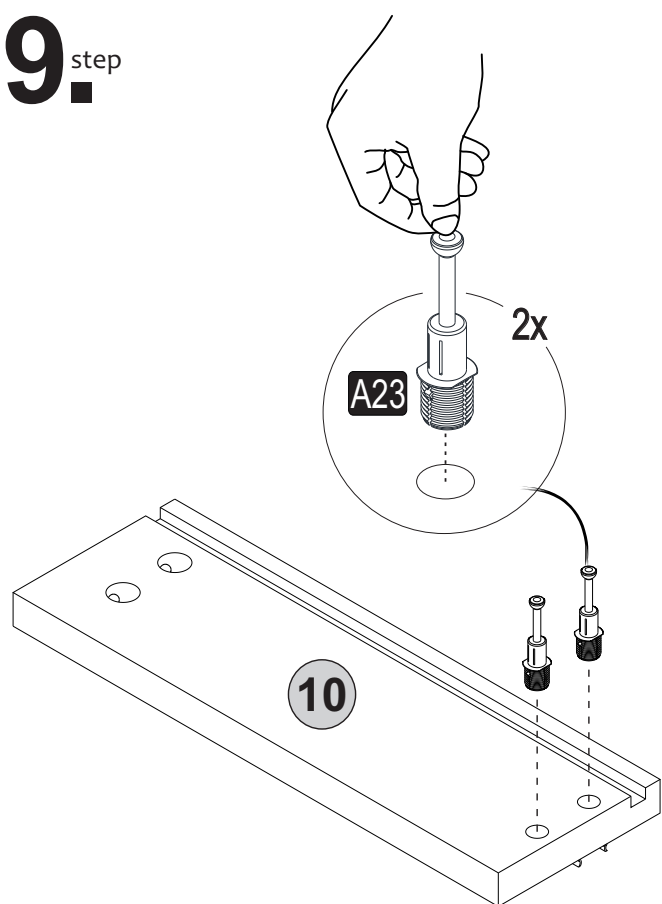

# 10<sup>step</sup>

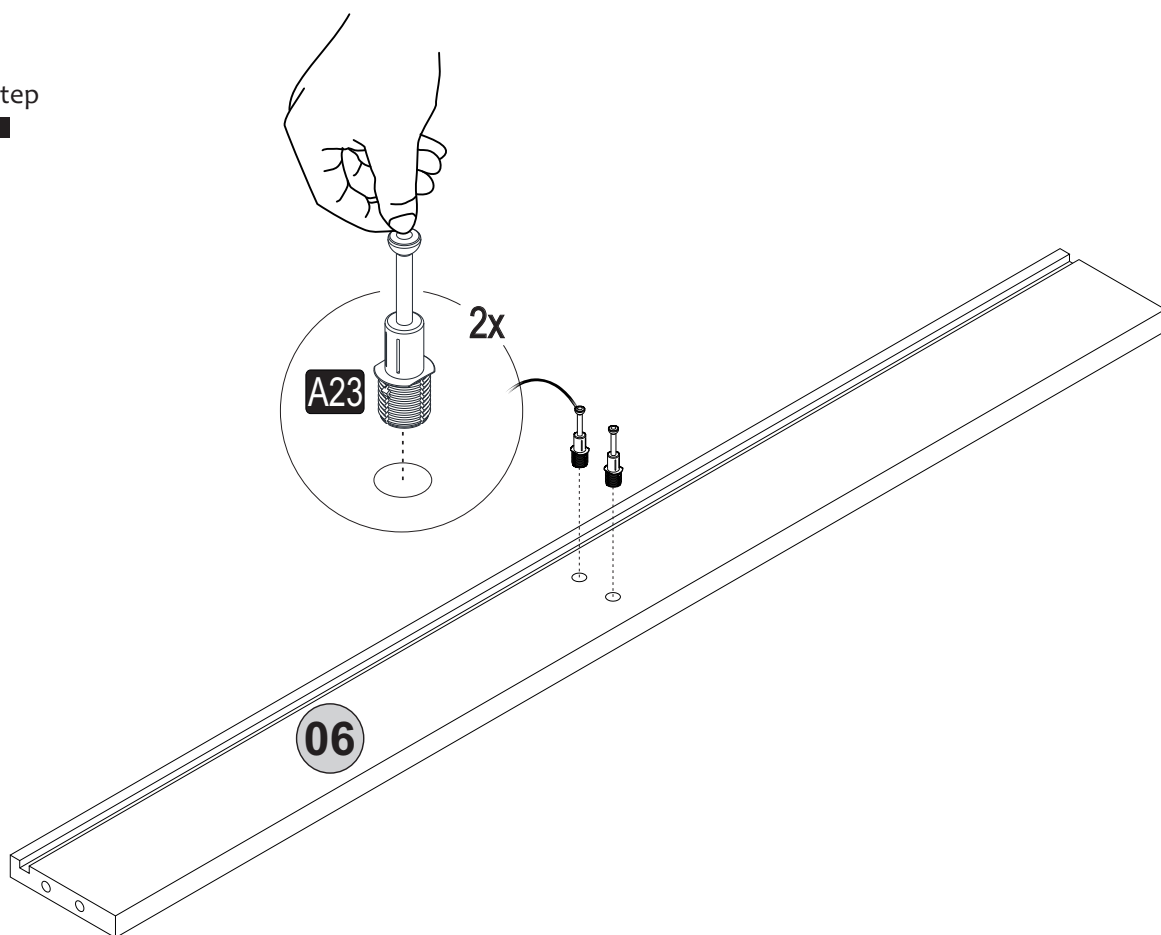

# 11.<sup>step</sup>

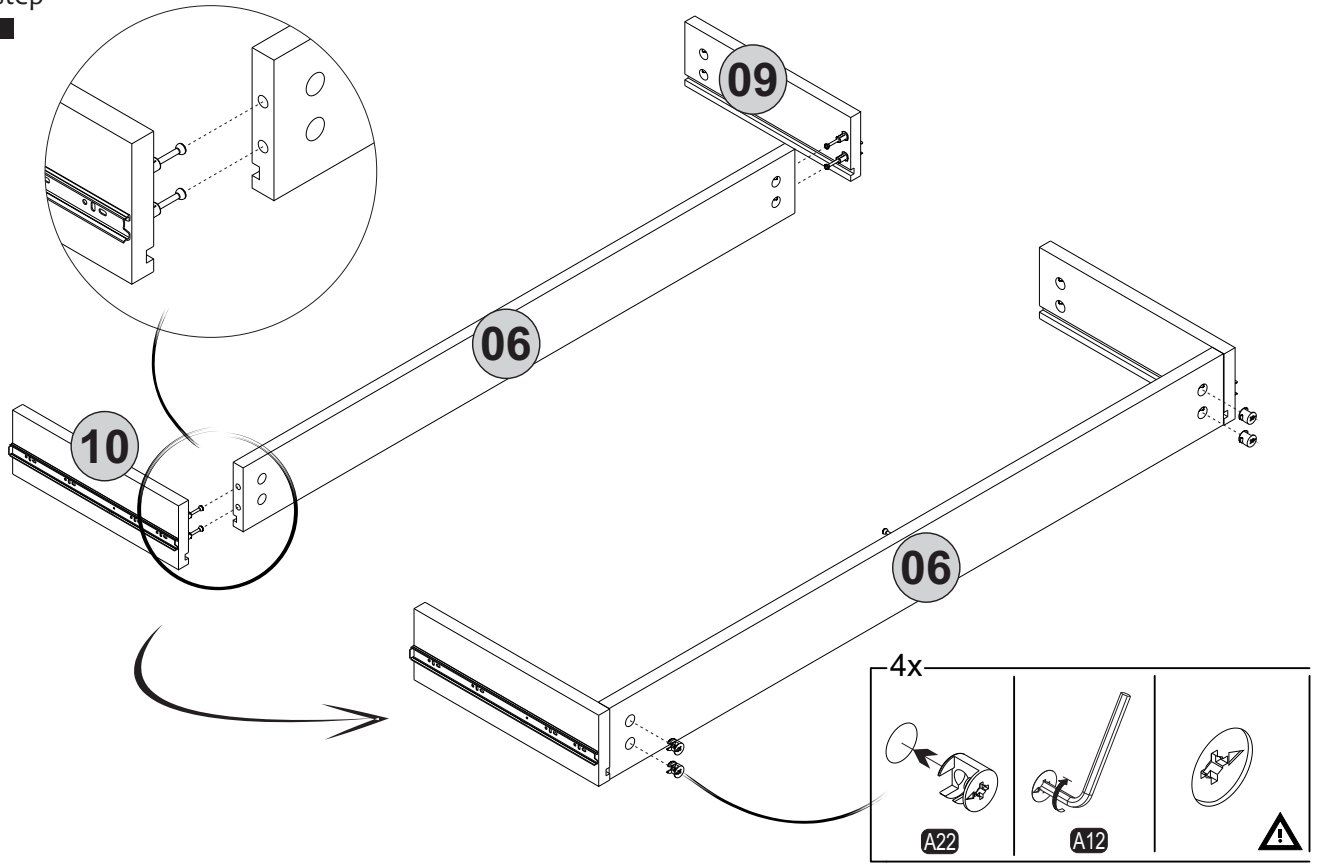

# 12.<sup>step</sup>

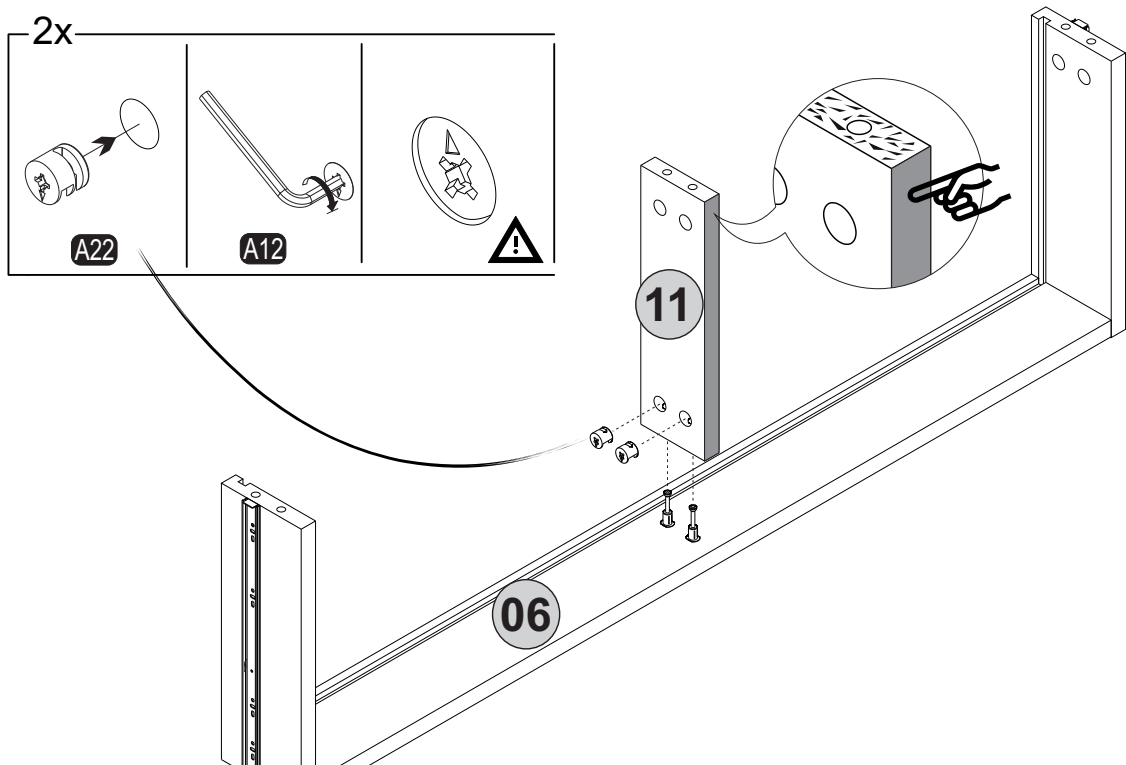

# 13.<sup>step</sup>

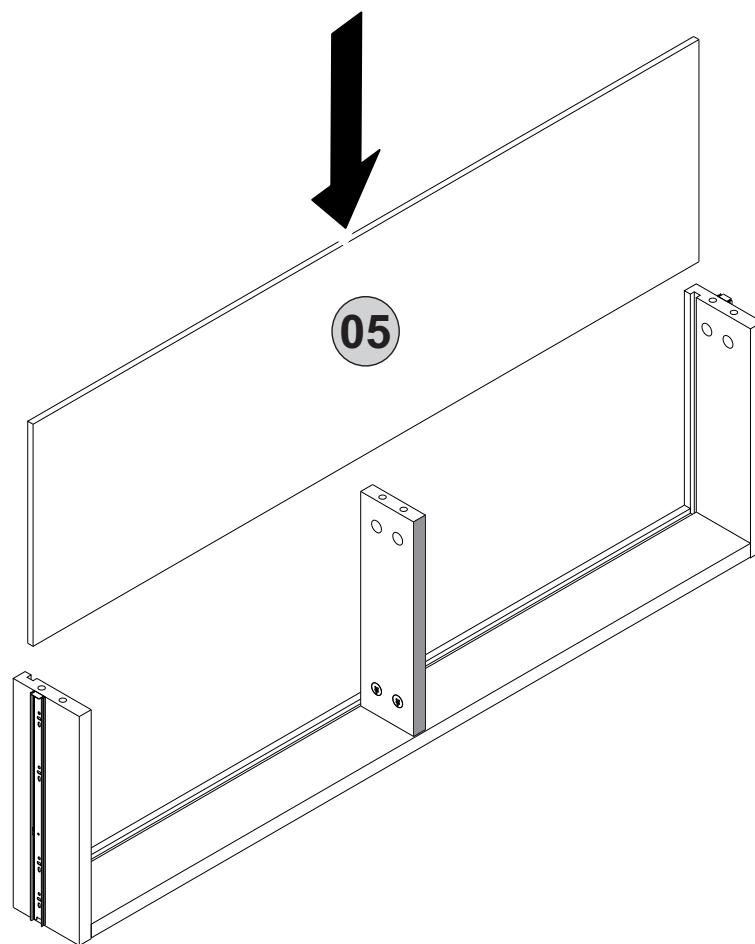

# 14.<sup>step</sup>

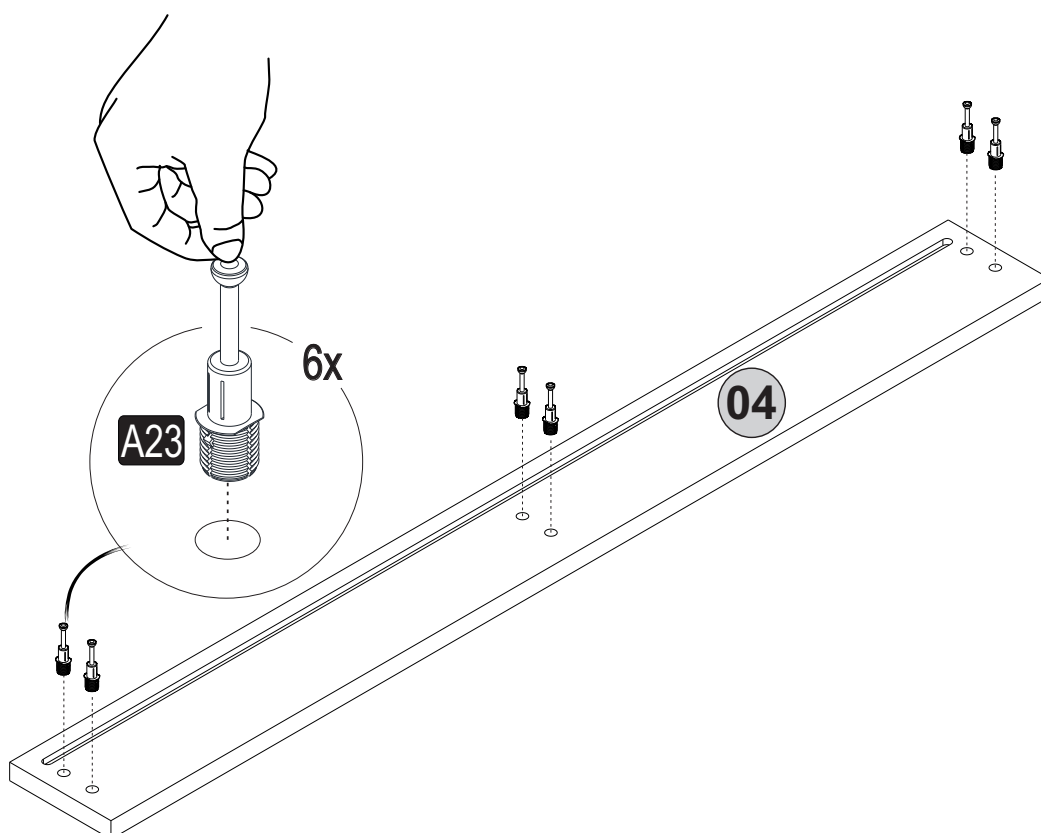

# 15.<sup>step</sup>

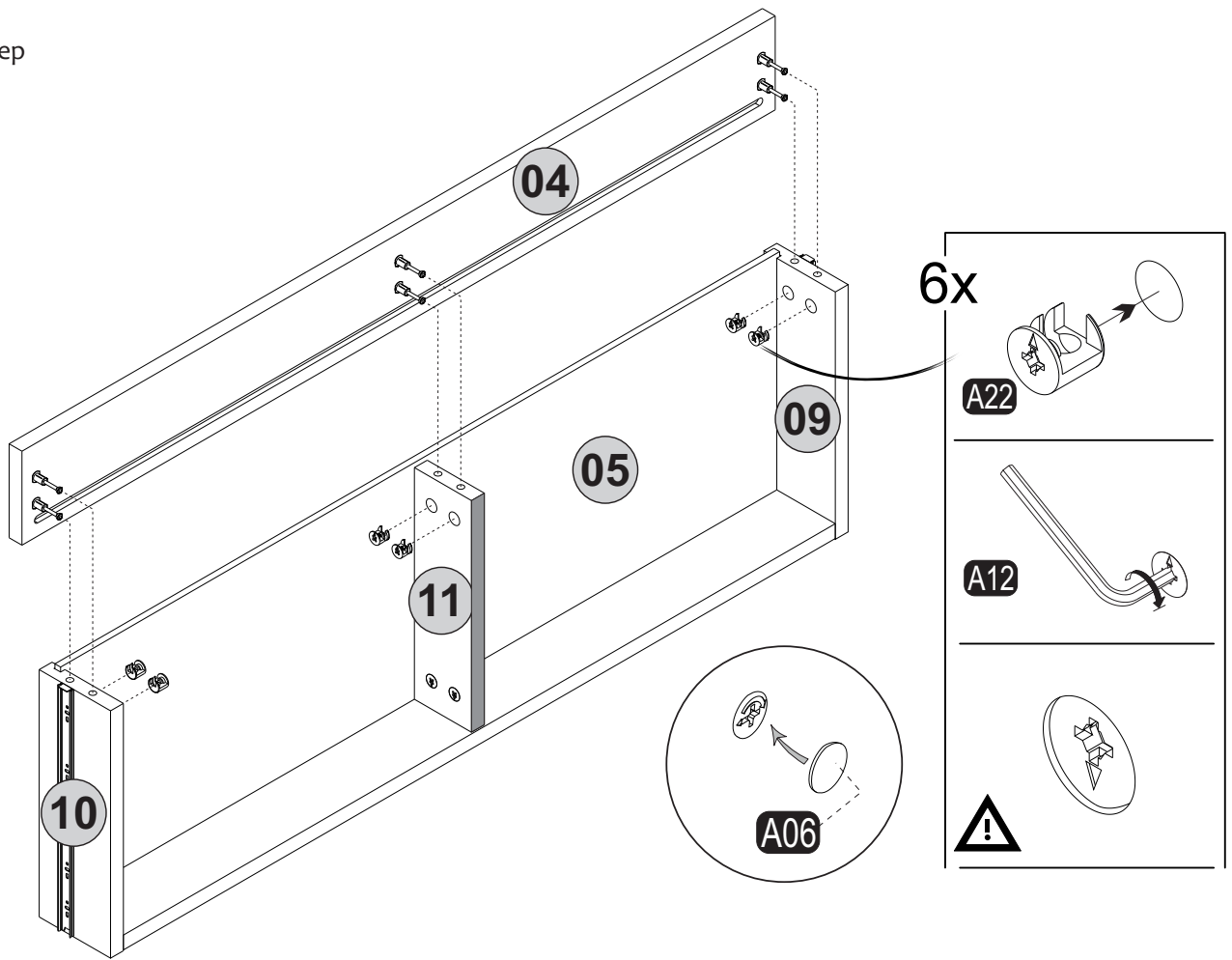

# 16.<sup>step</sup>

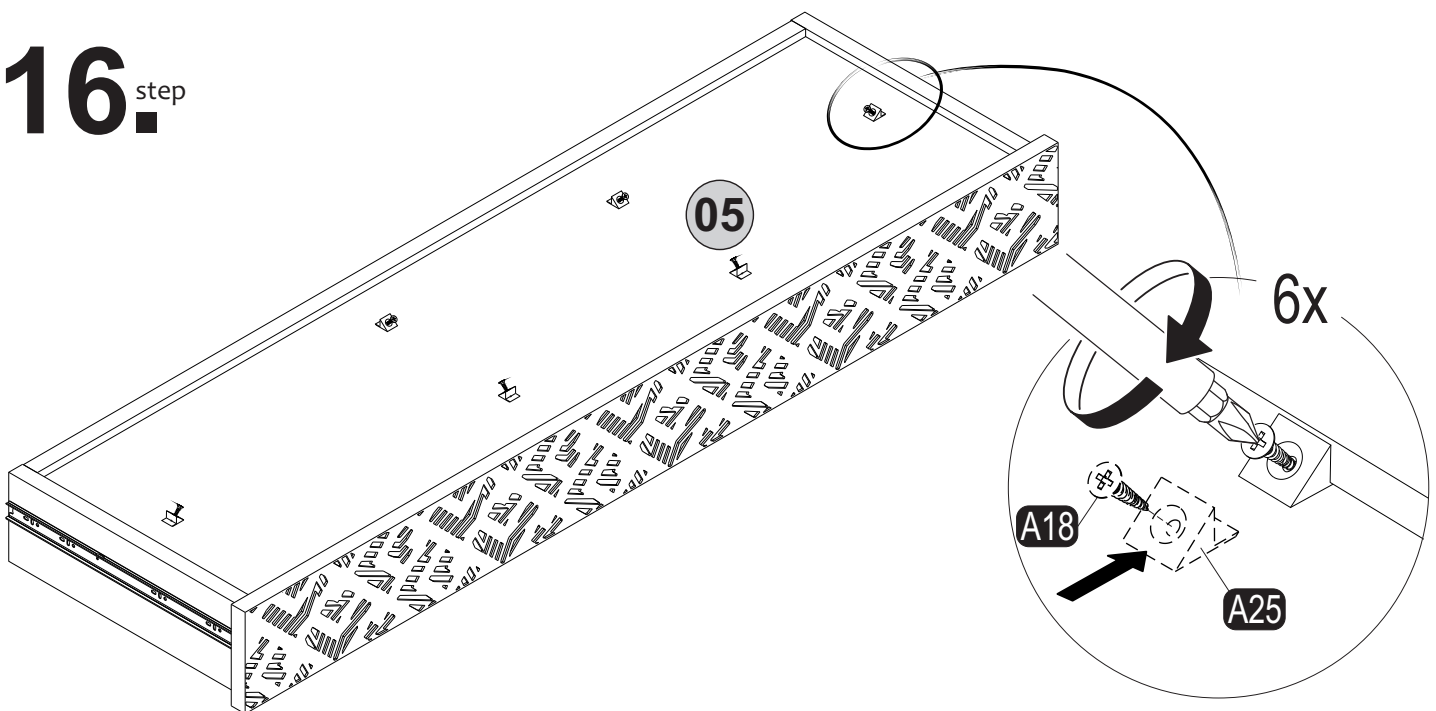

# 17.<sup>step</sup>

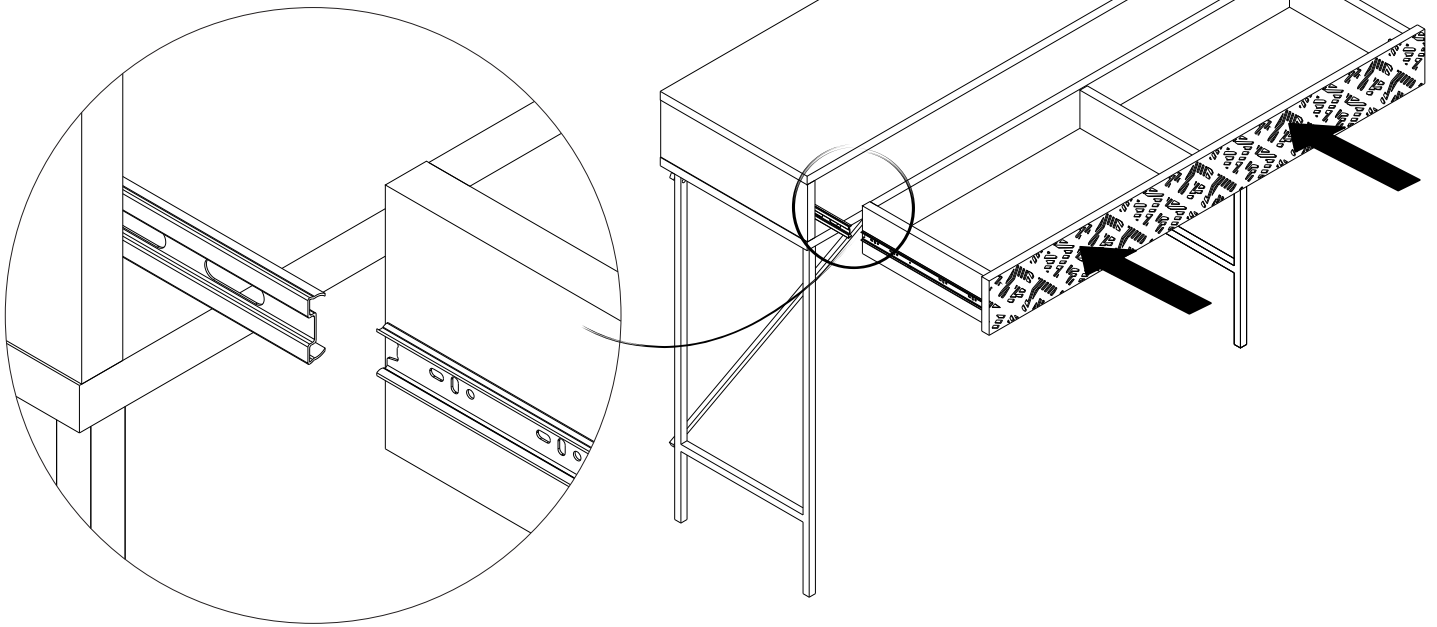

# 18.<sup>step</sup>

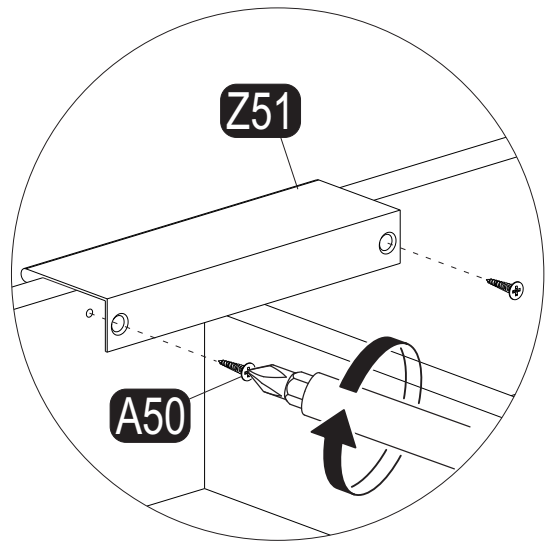
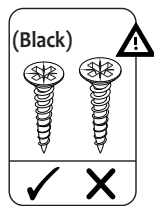
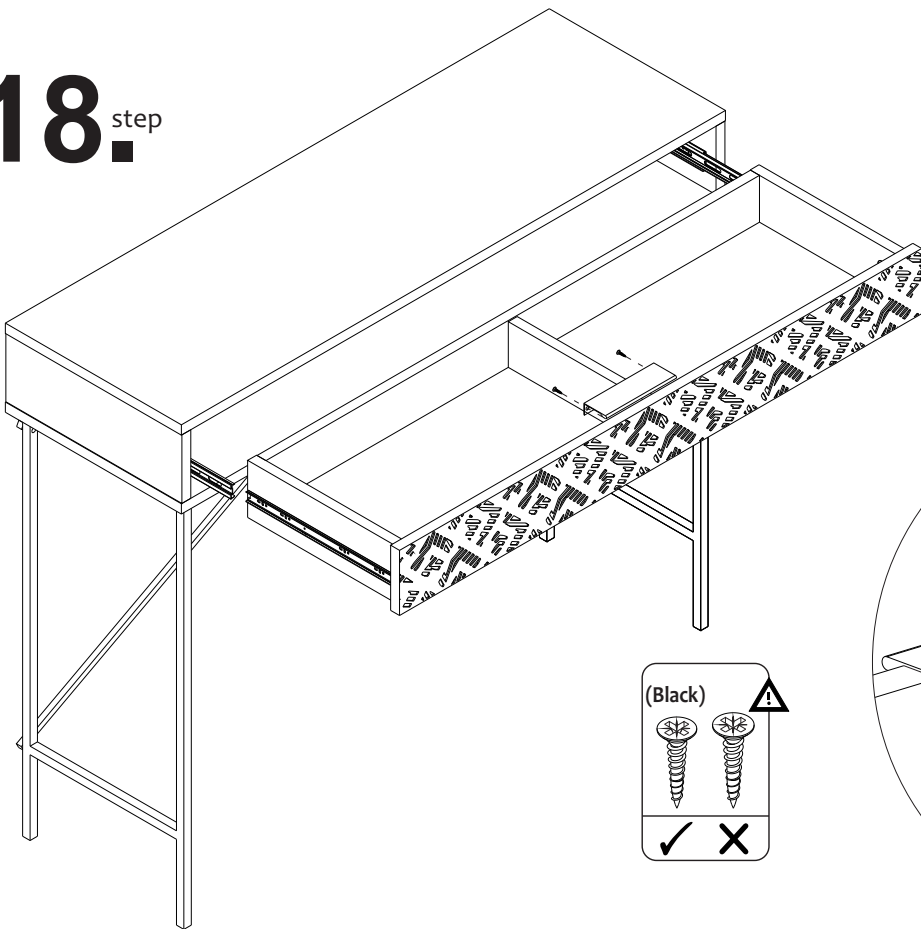

# 19<sup>step</sup>

