

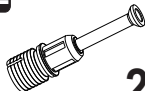

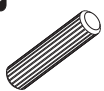





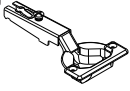

i GP042-0324,2

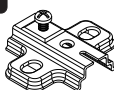

233 x 31,3 x 196,8cm

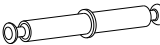
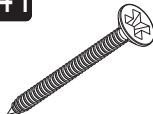
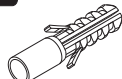
A01  36x	A02  28x	A03  28x	A11 TDB  4x	A12 DM  6x
A04  A 24x D 12x	A16  A 36x D 11x	A09 4x50  11x	A10 3,5x18  40x	A13  10x
A28  28x	A29 3,5x30  44x	A56 Sgmnl  7x68 mm 4x	D41 5x70  6x	D69 Ø8  6x
F38  25 MM 5x	E17  2x			

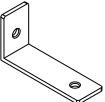
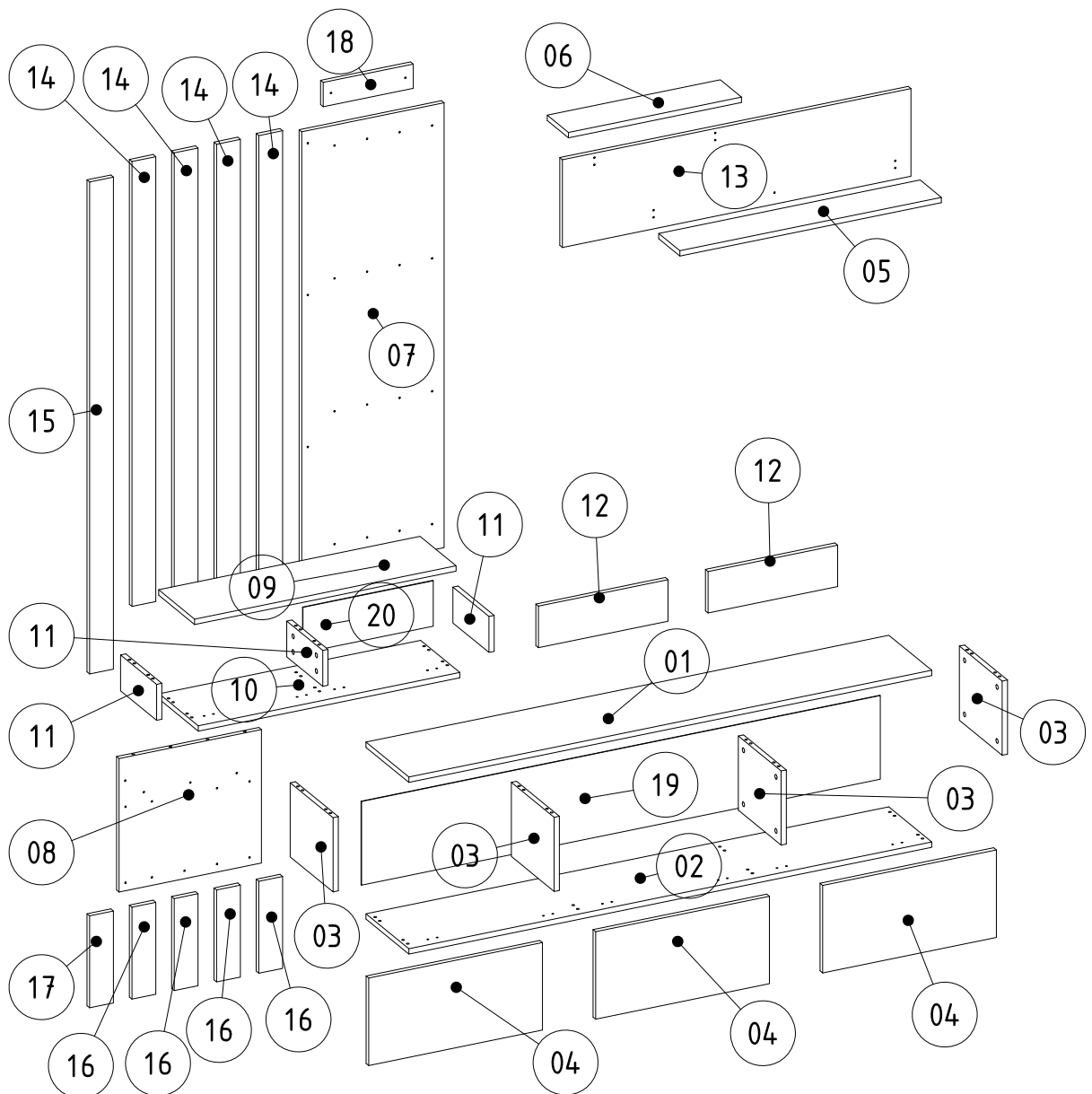

1

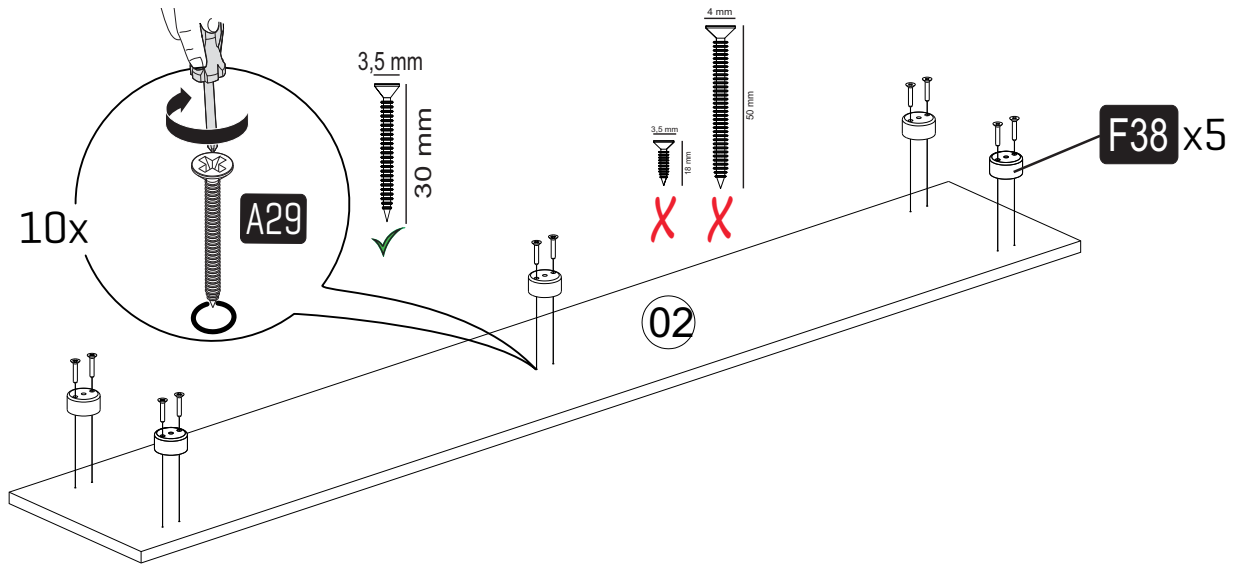

2

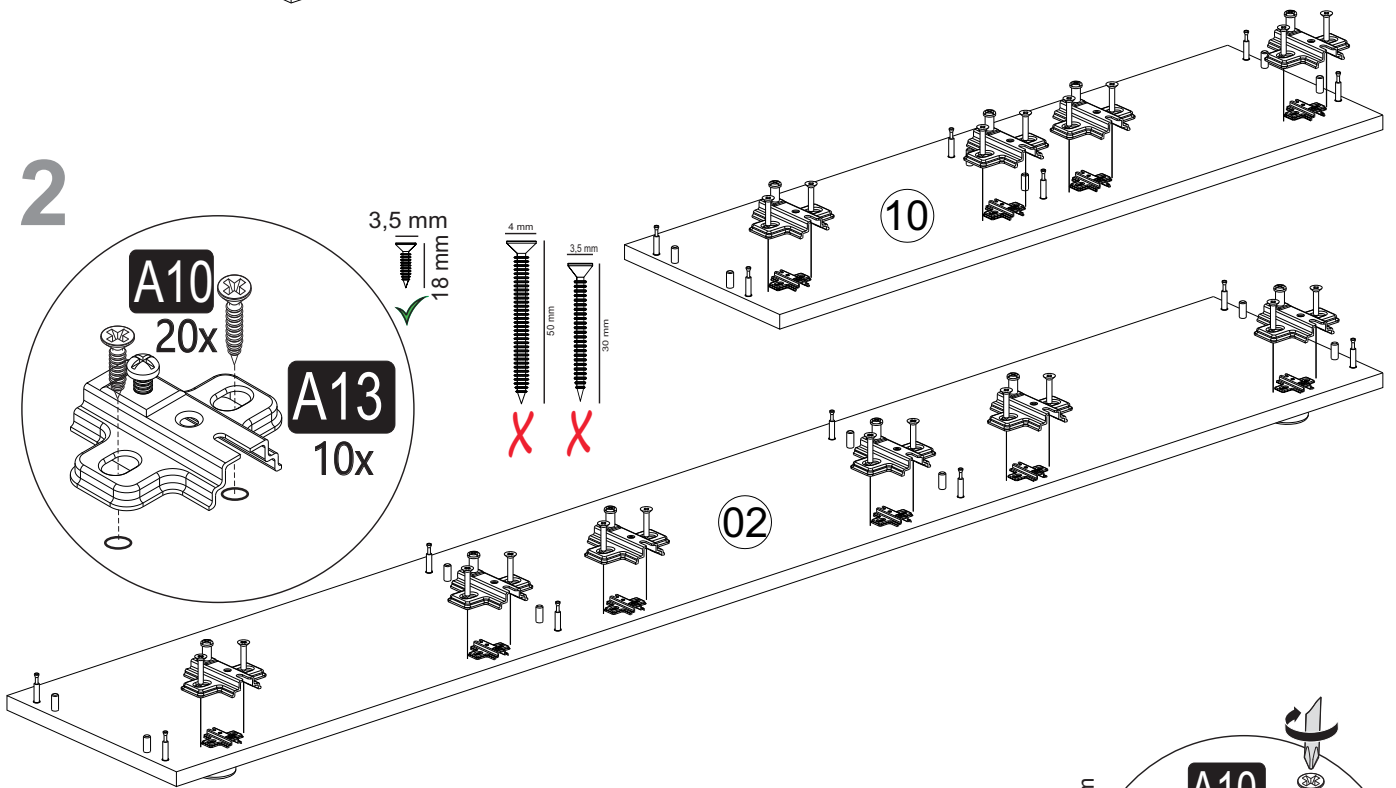

3

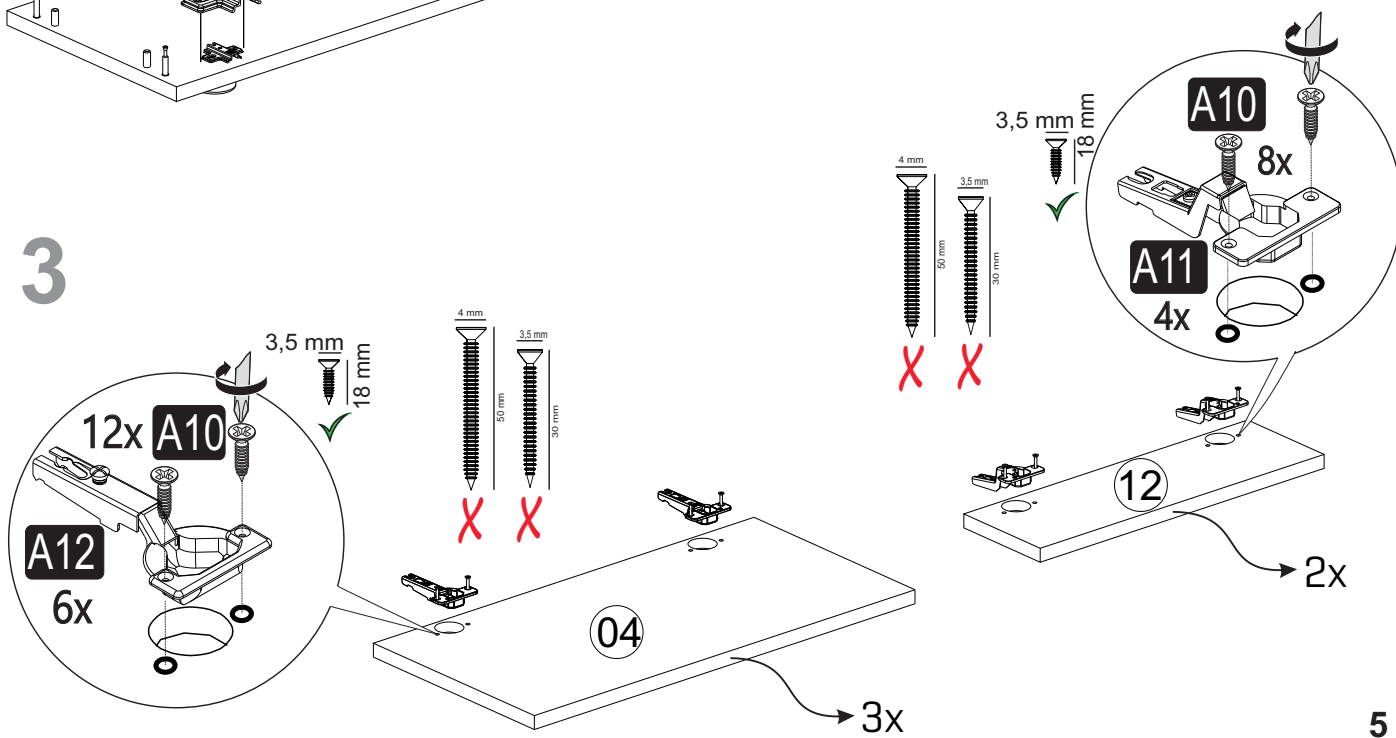

4

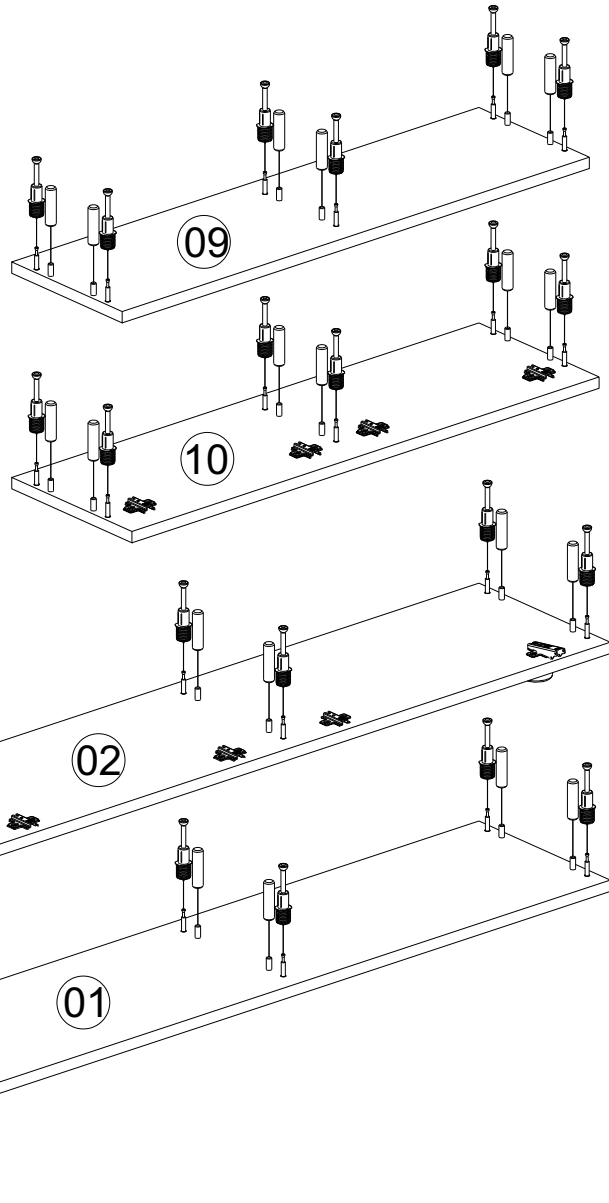
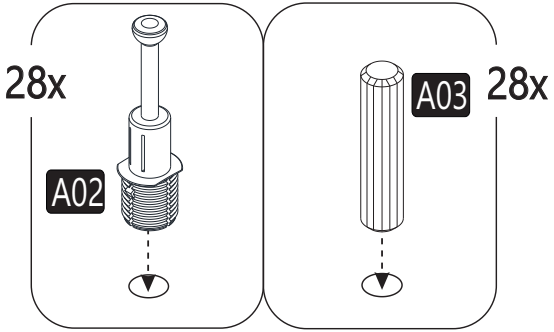

5

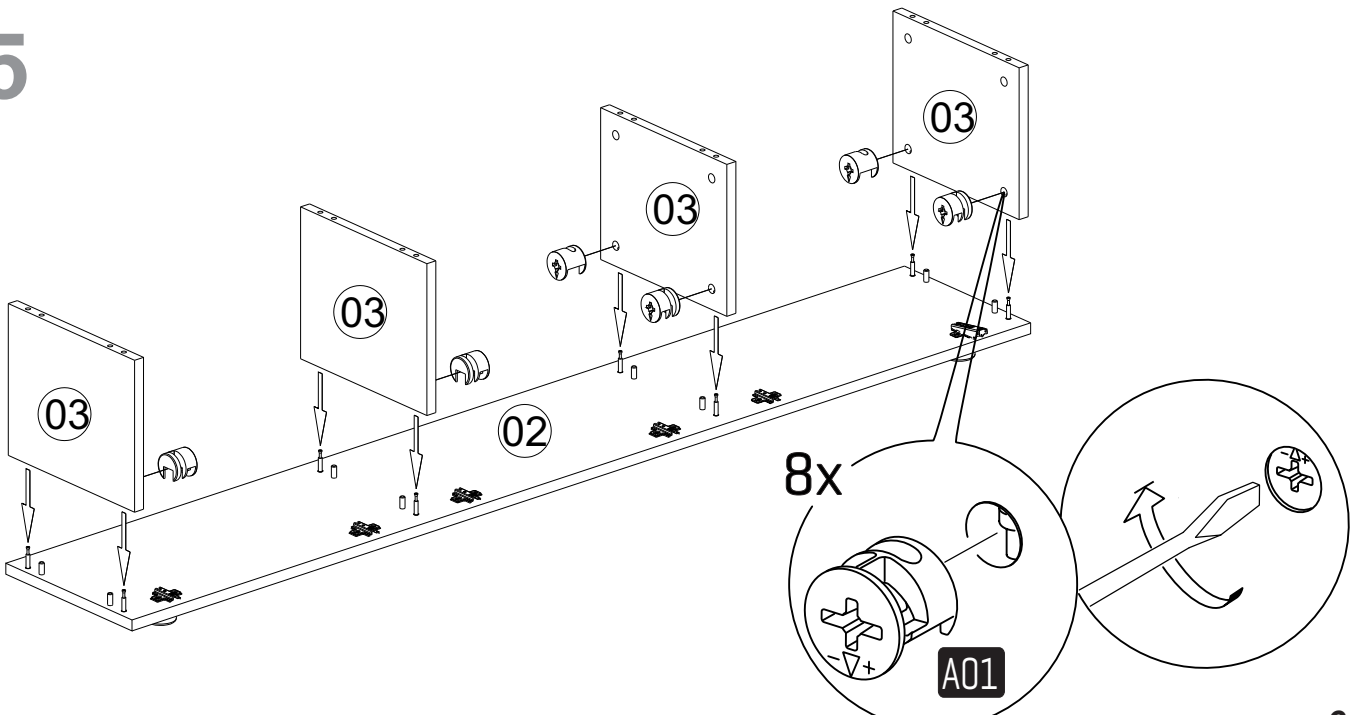

6

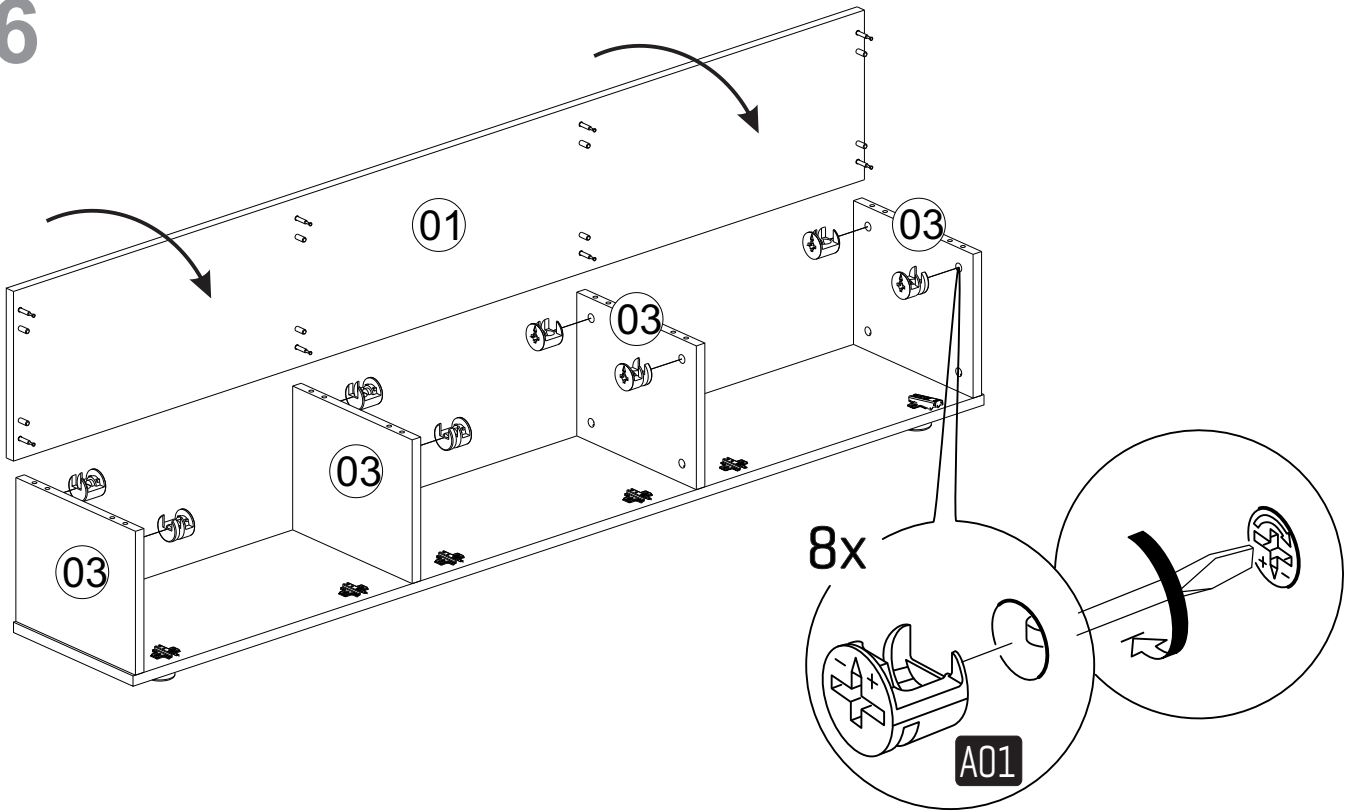

7

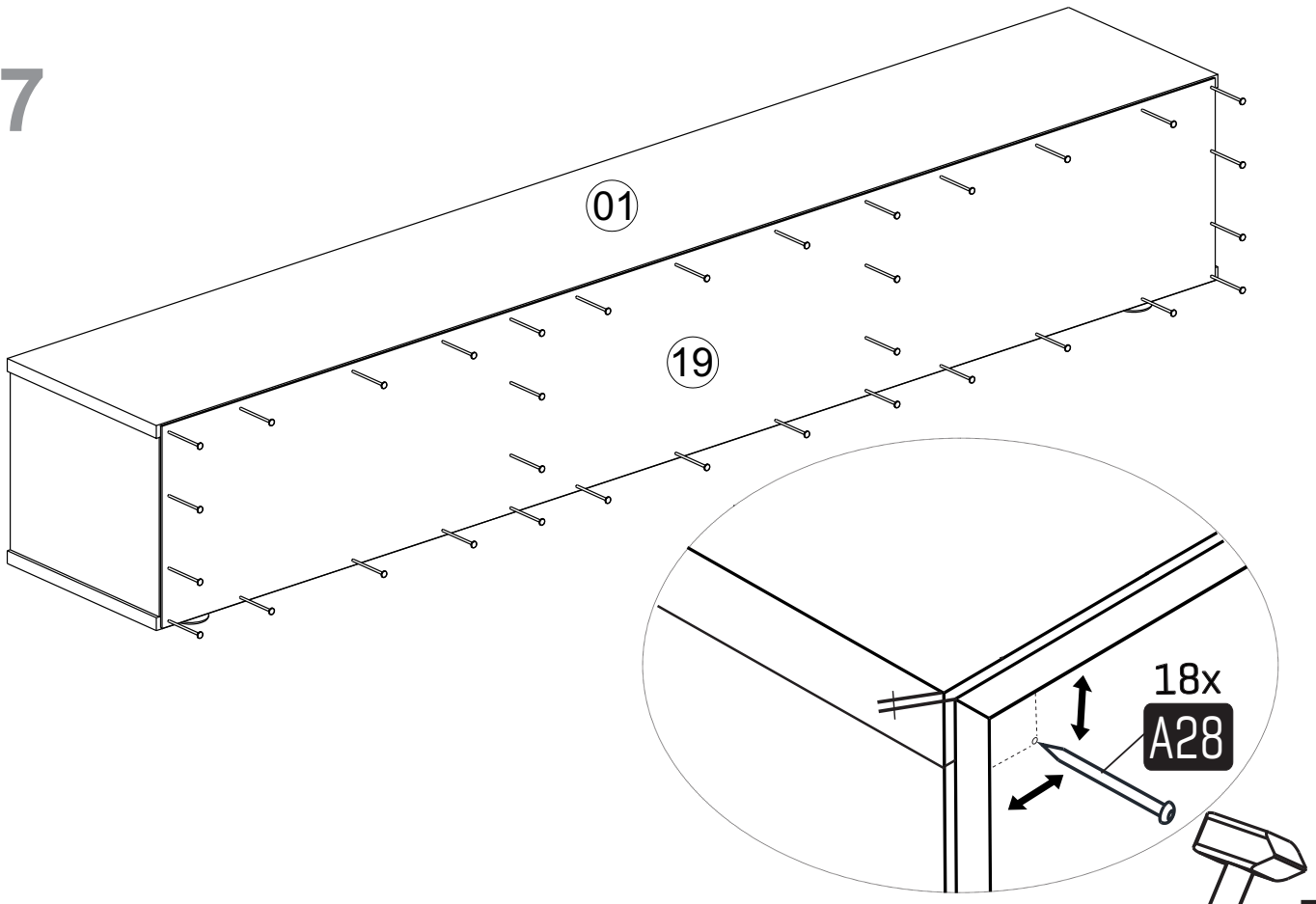

8

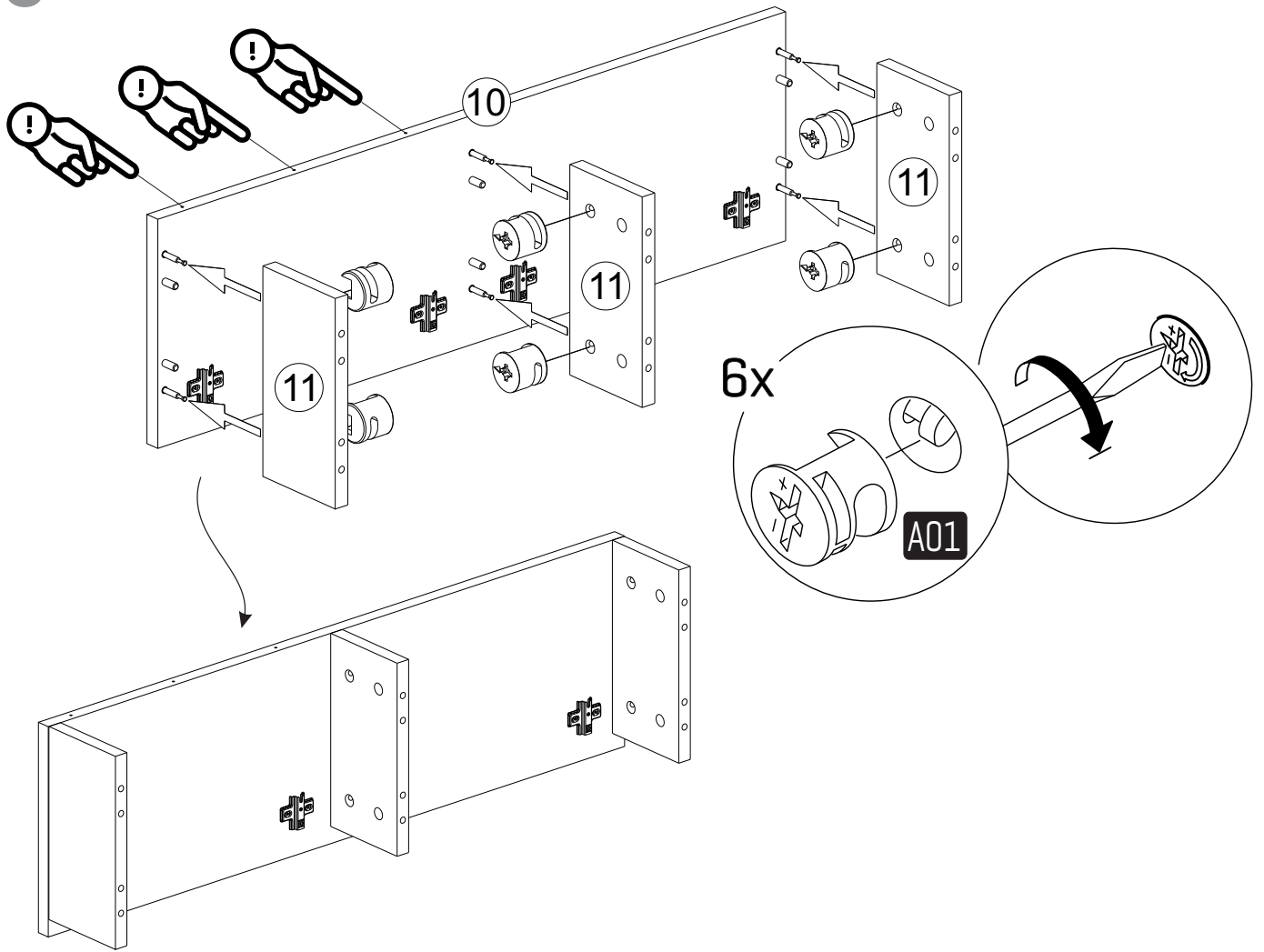

9

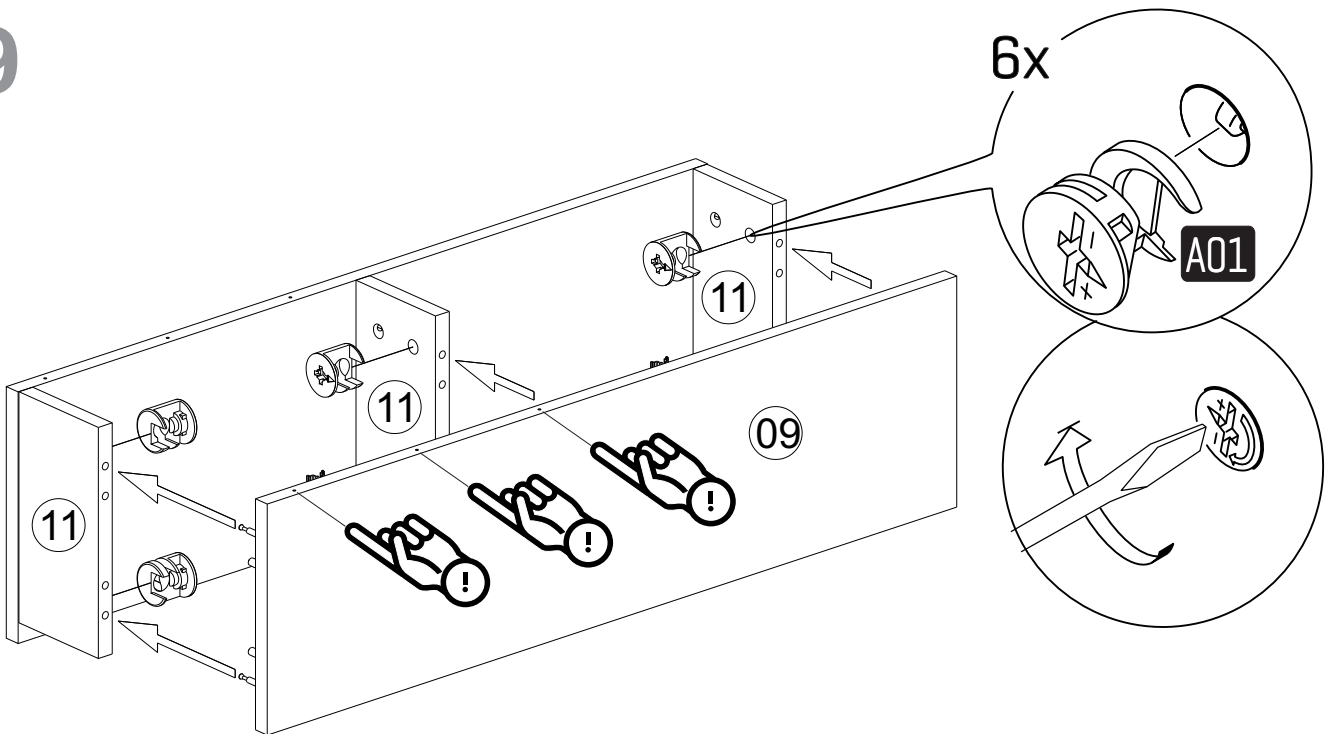

10

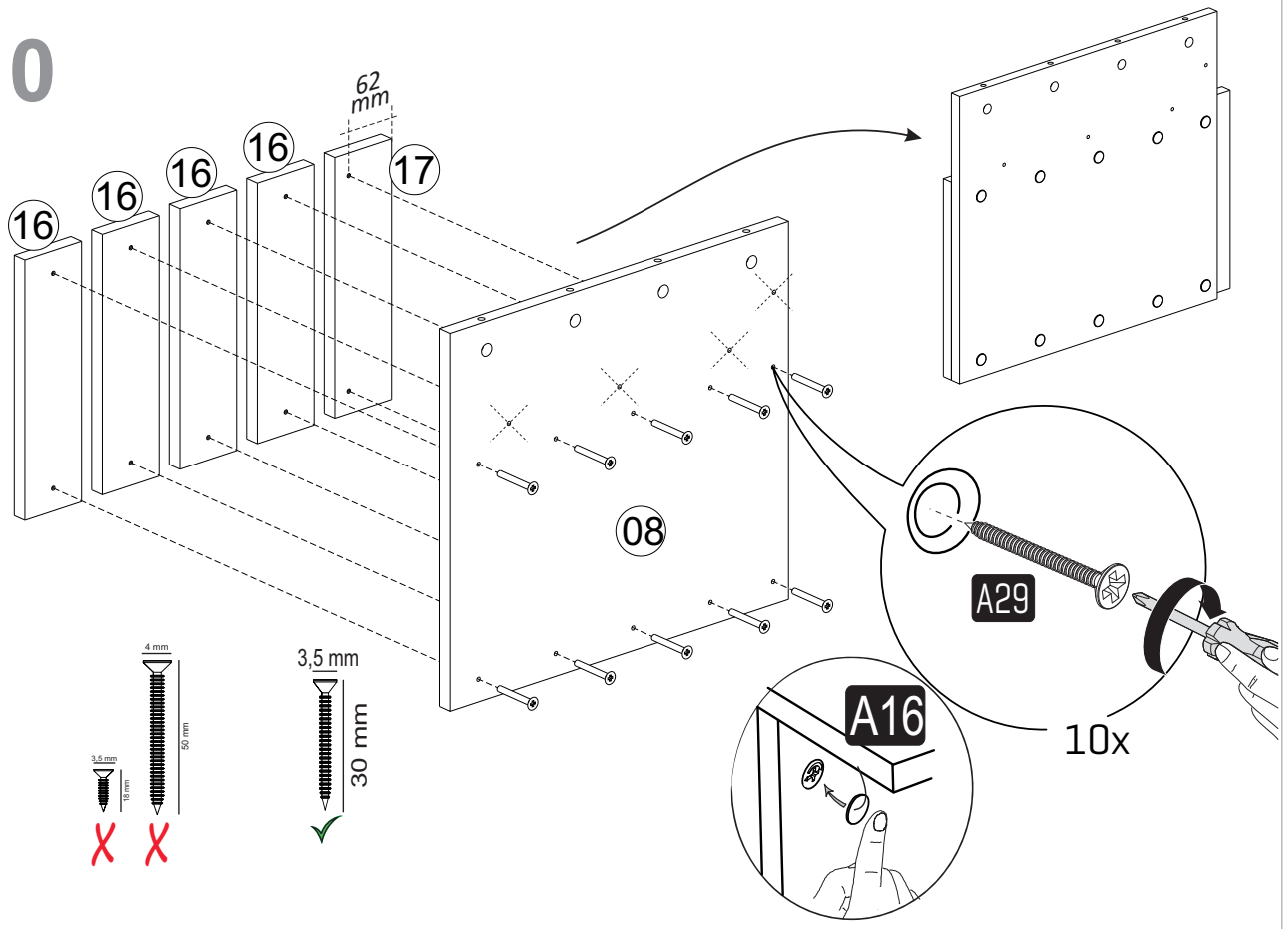

11

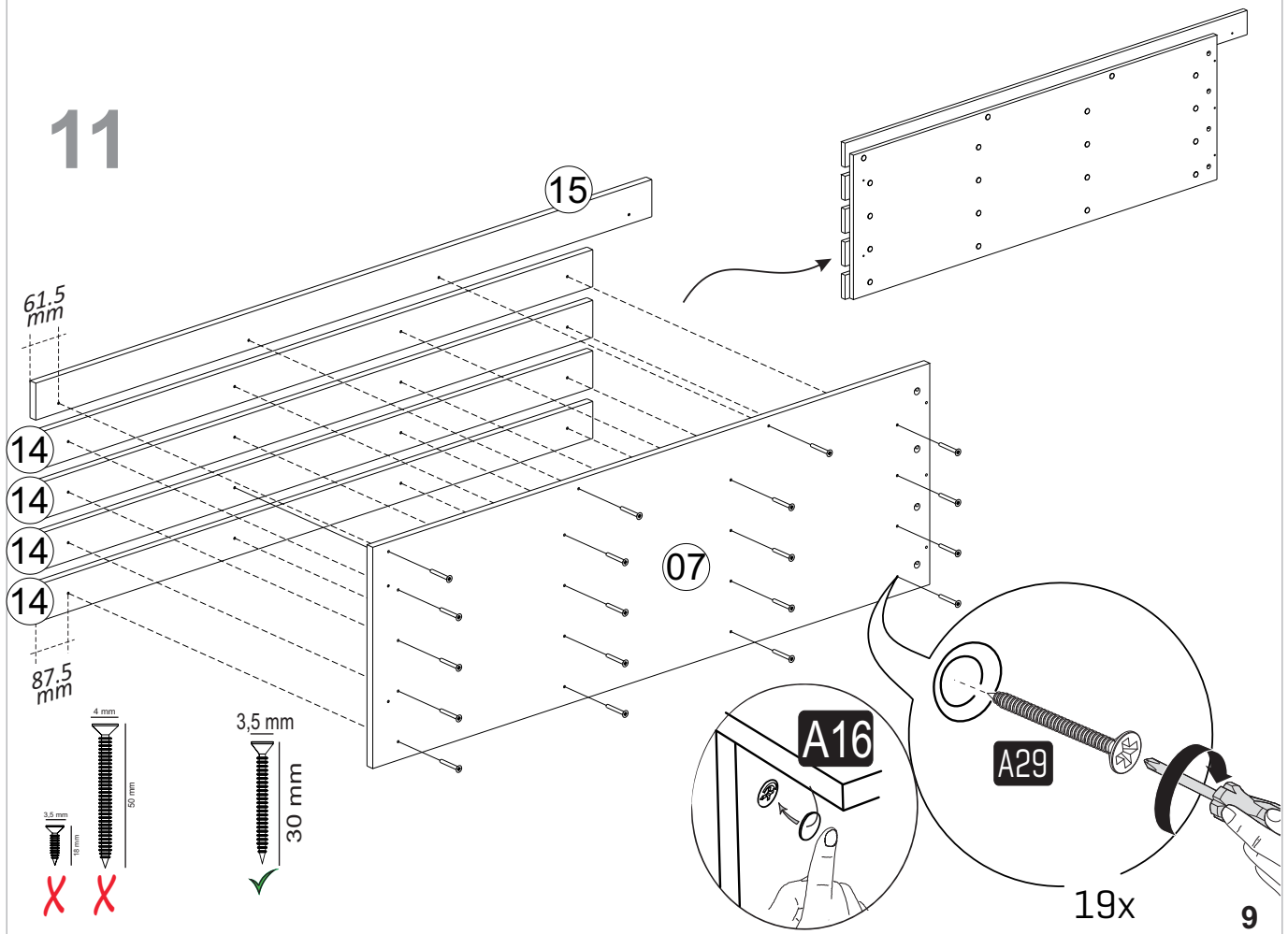

12

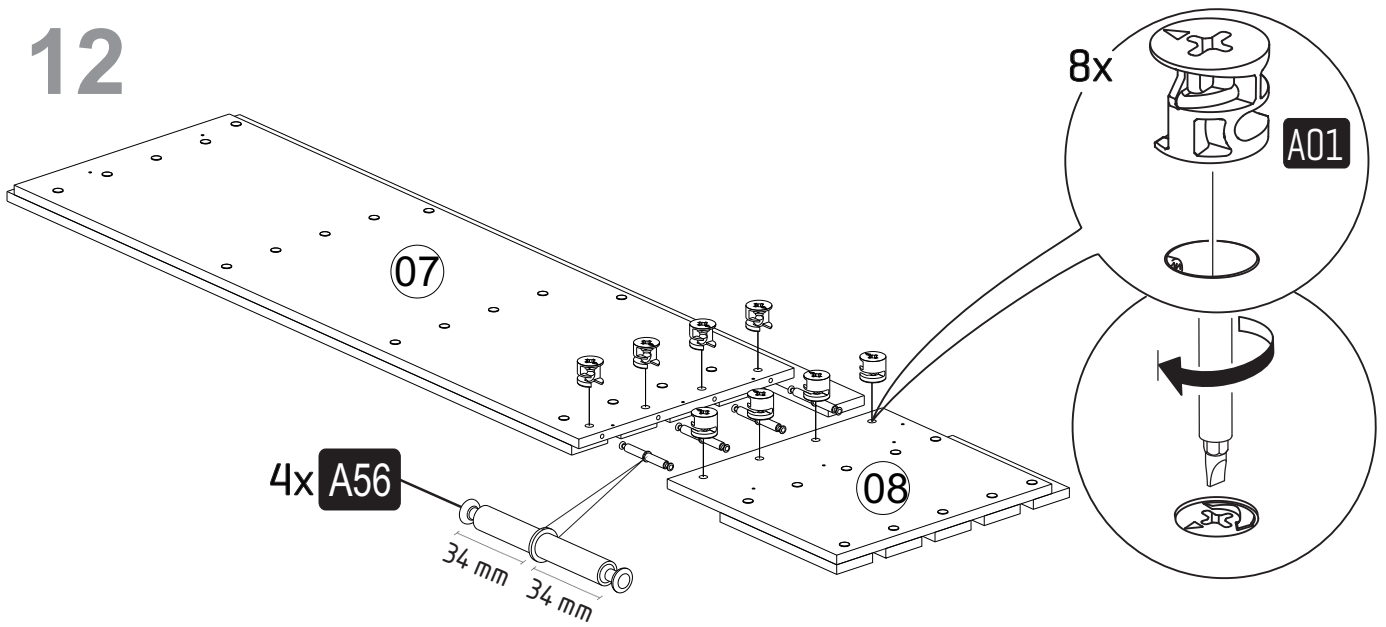

13

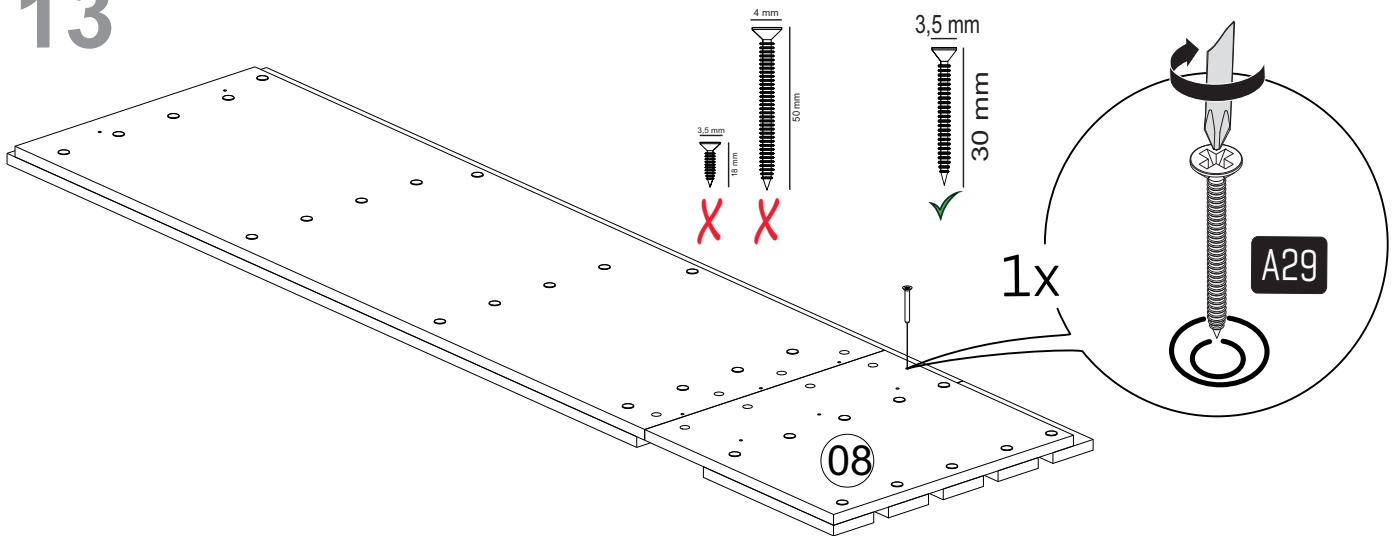

14

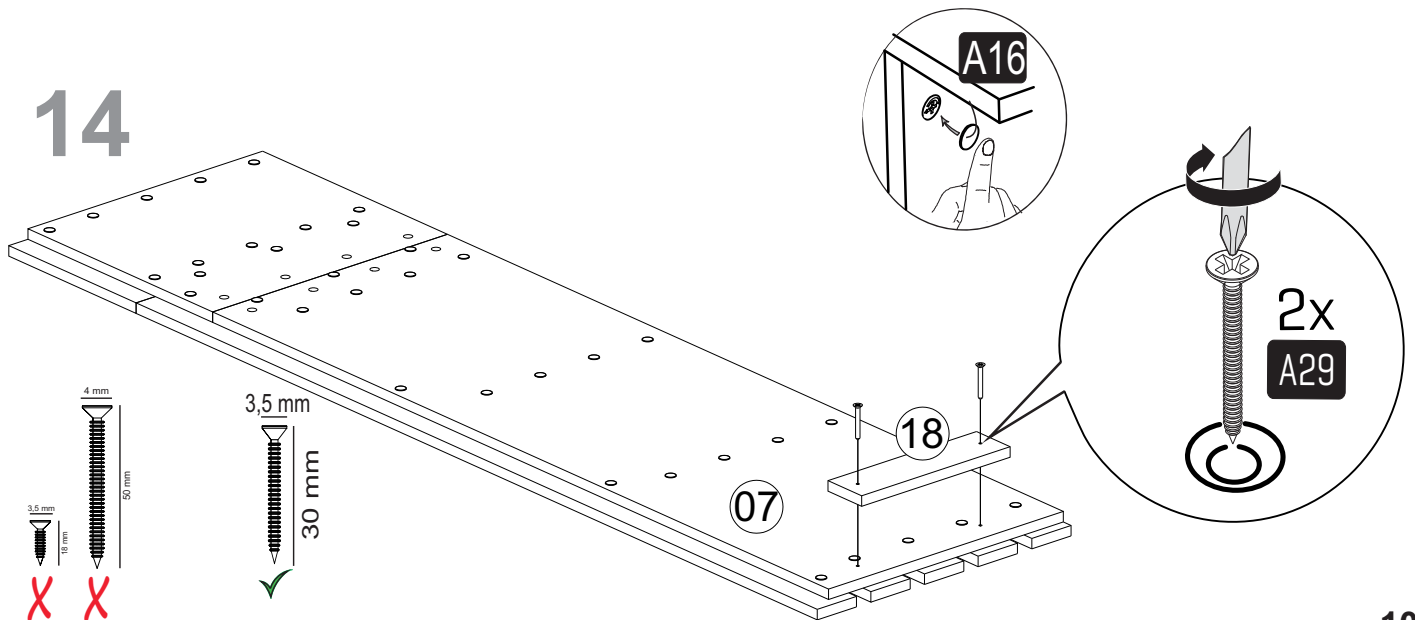

15

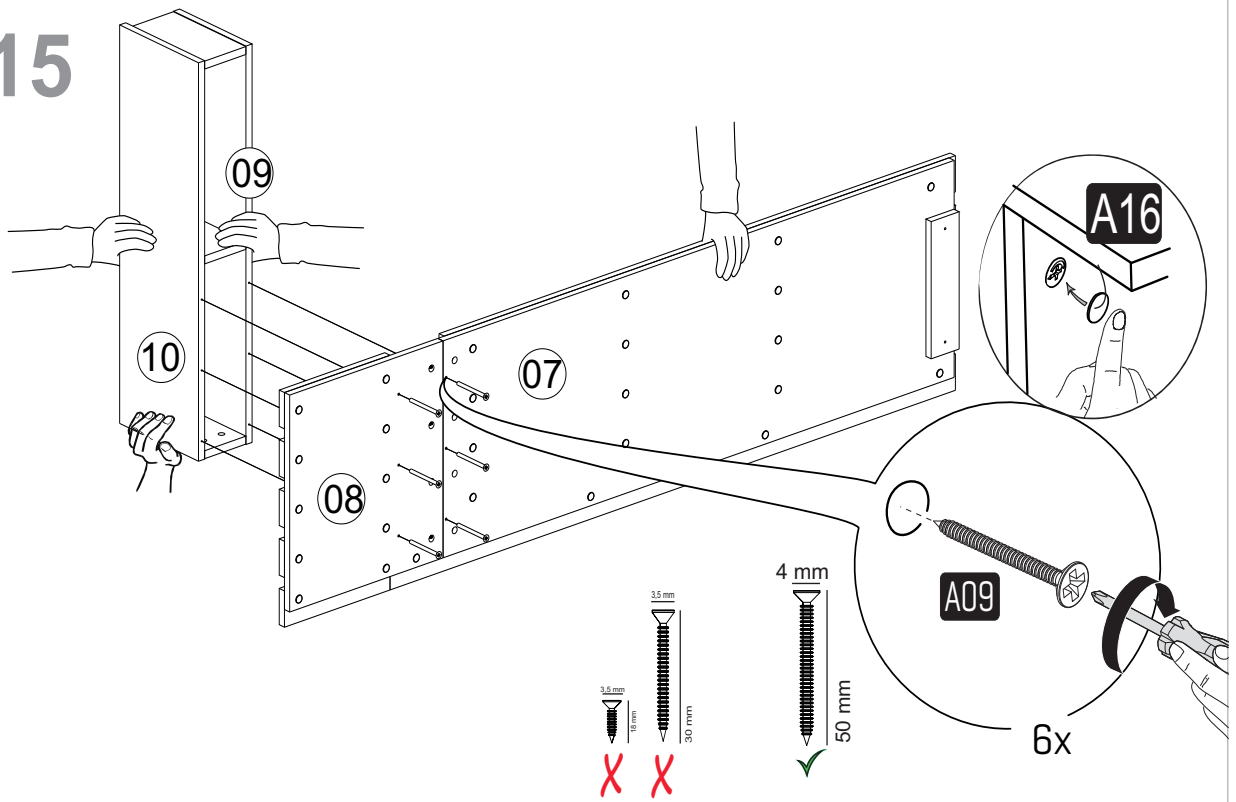

16

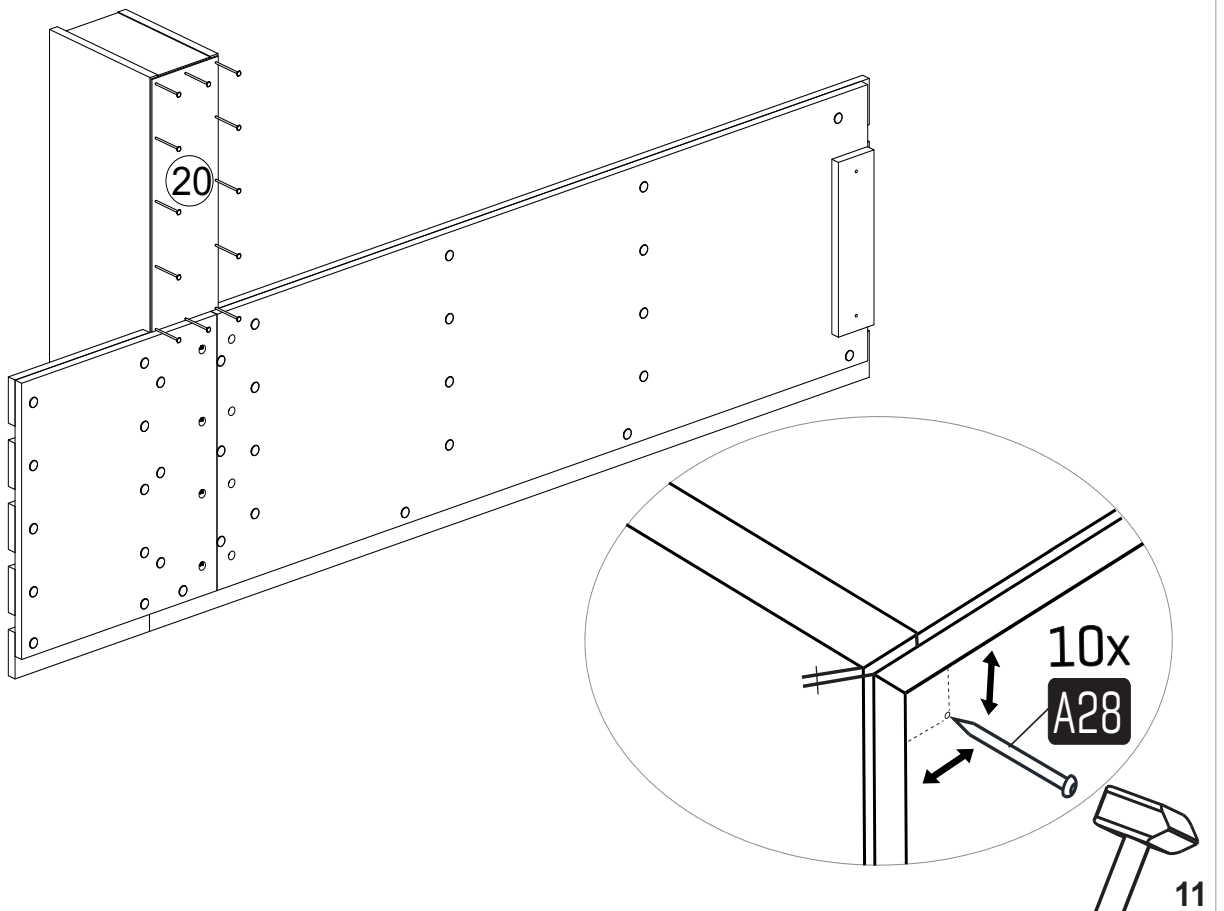

17

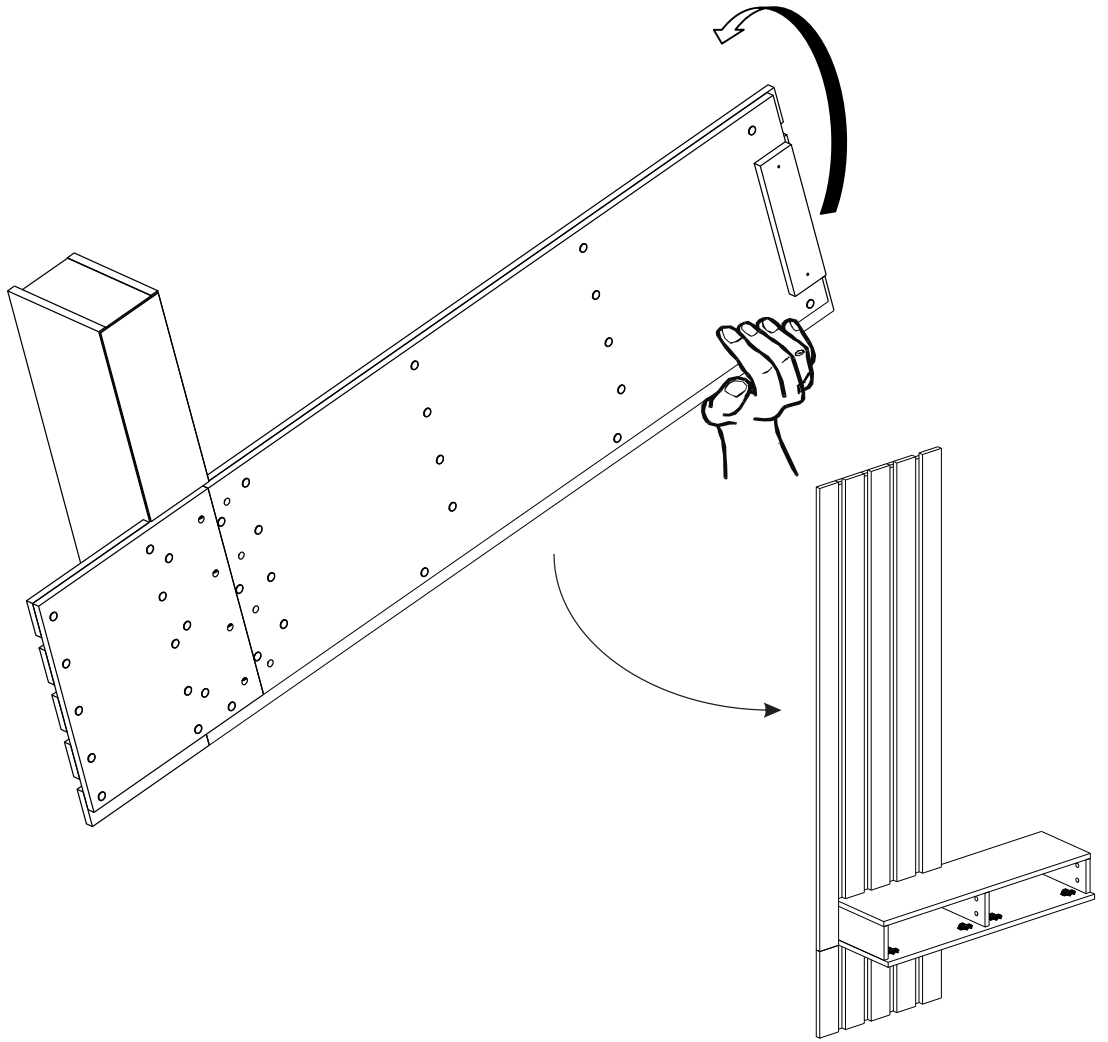

18

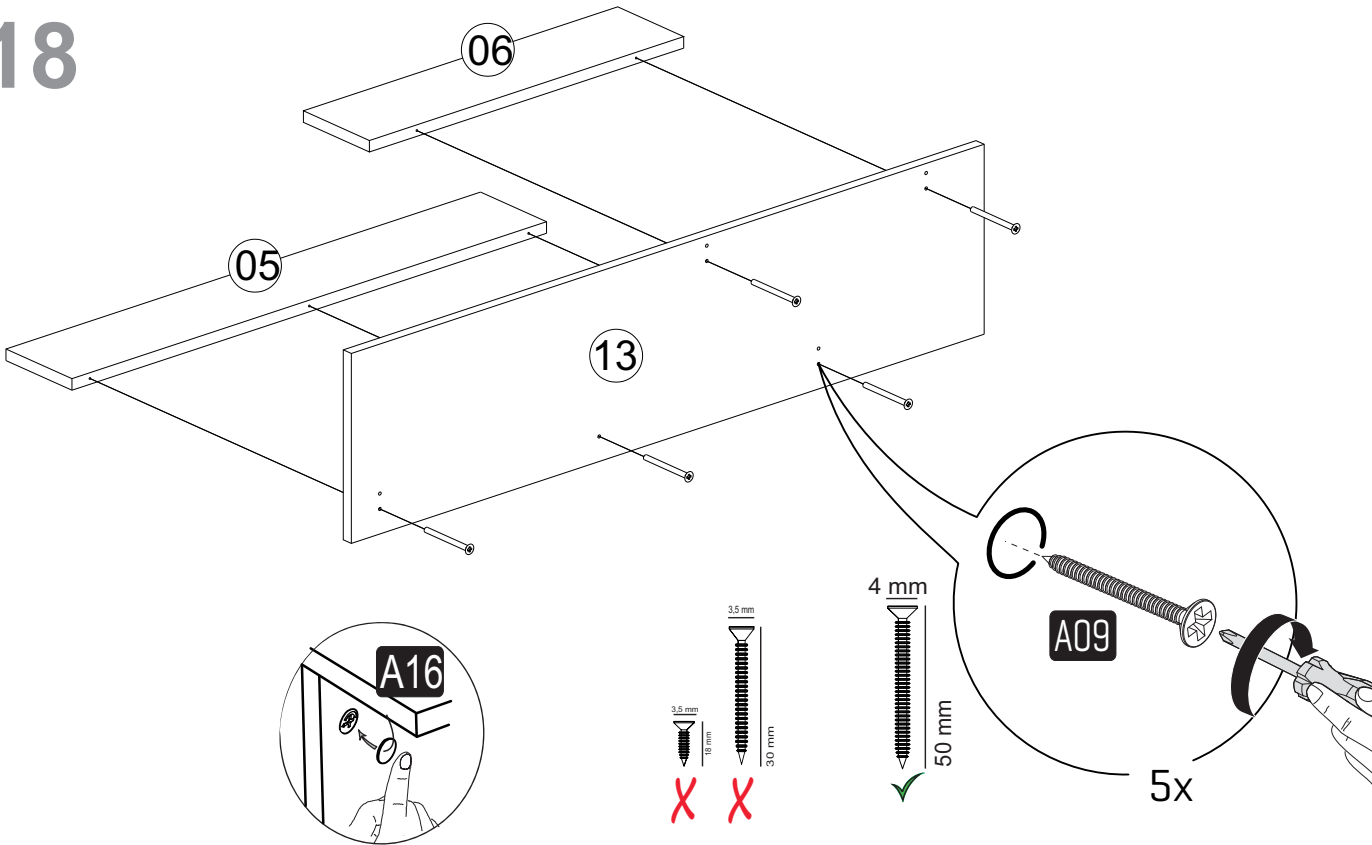

19

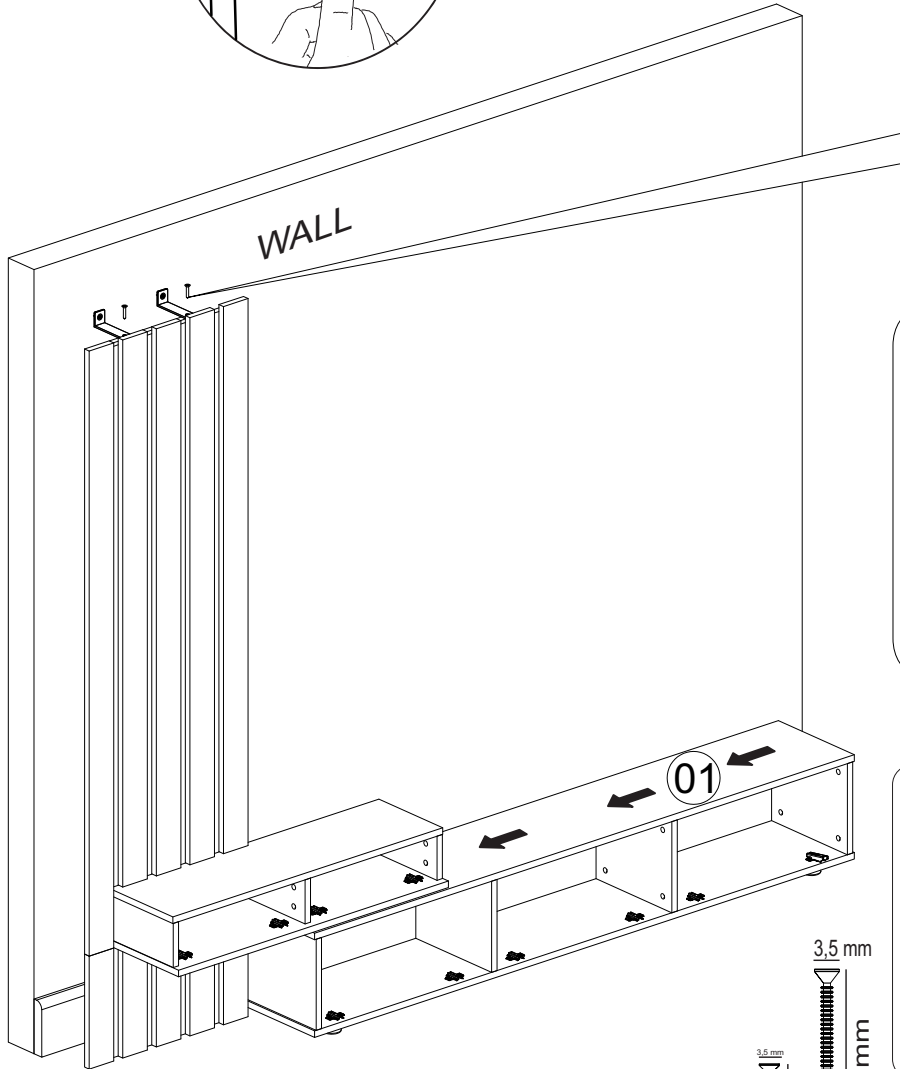

PART-1

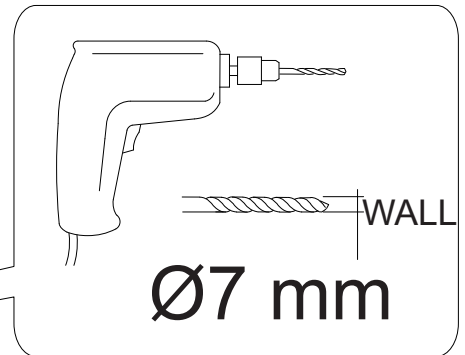

PART-2

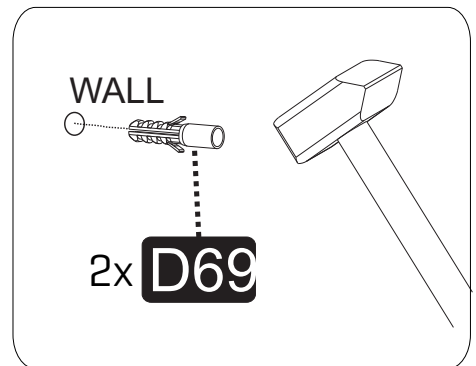

PART-3

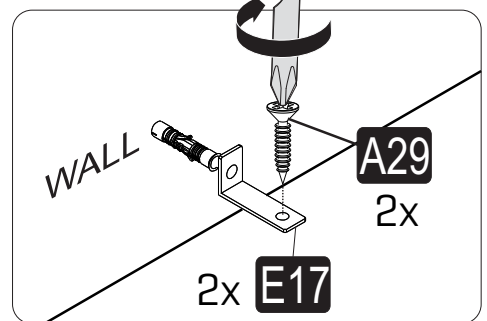

PART-4

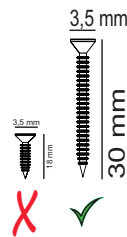
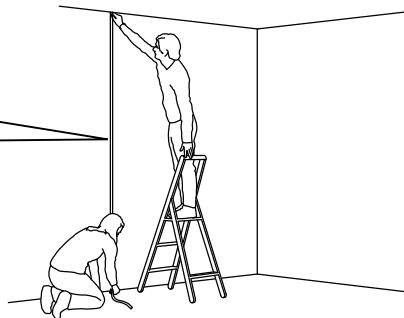
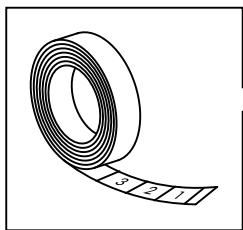
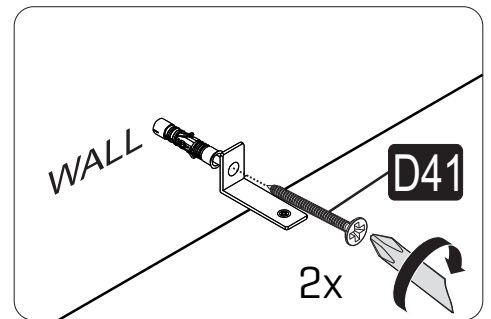

20

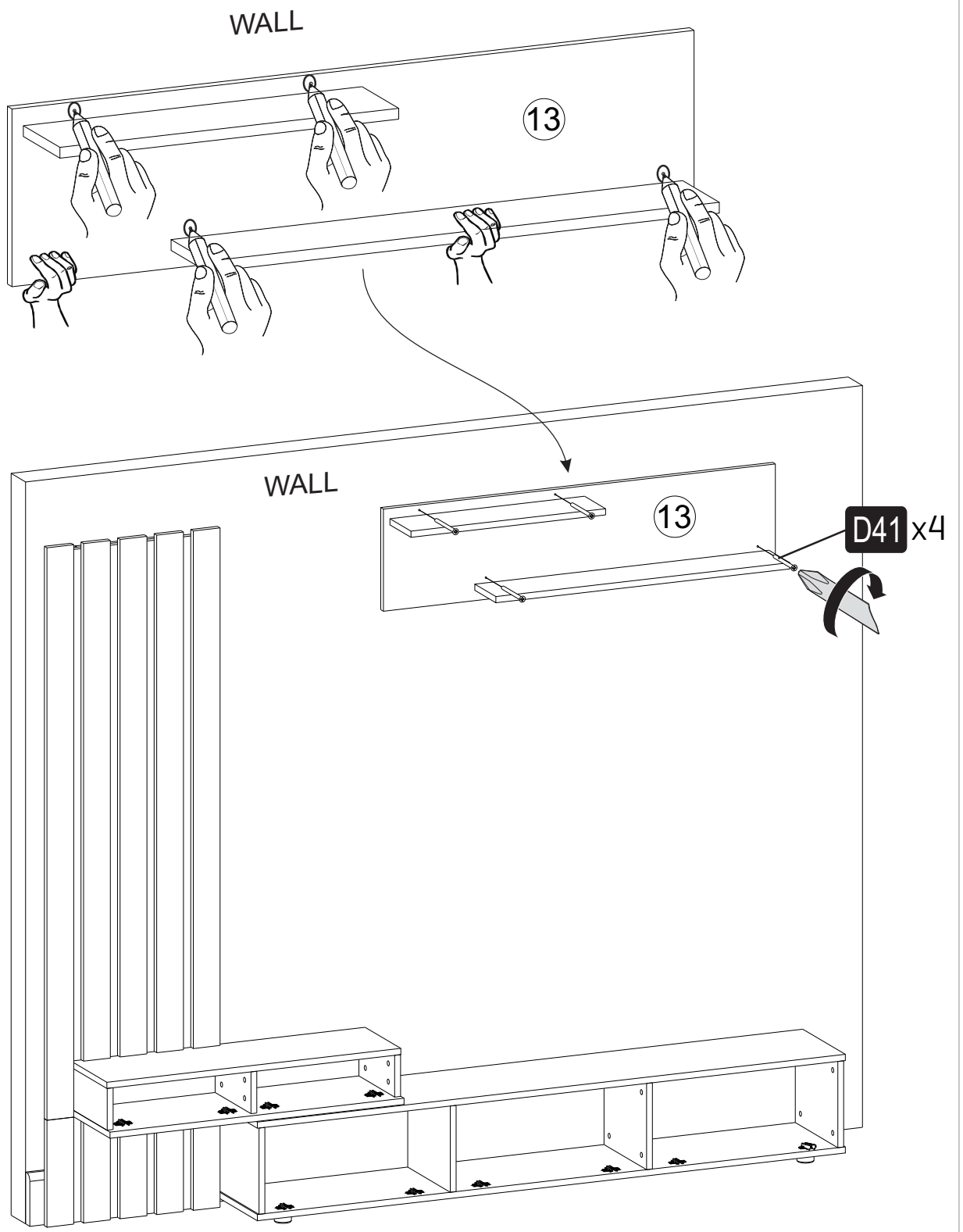

PART-1

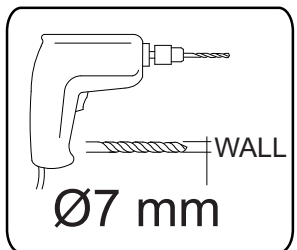

PART-2

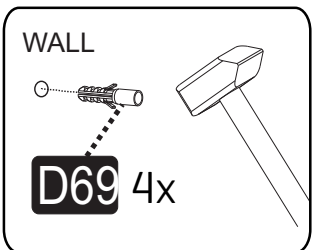

PART-3

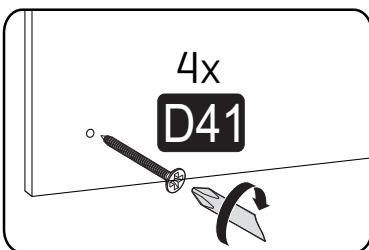

PART-4

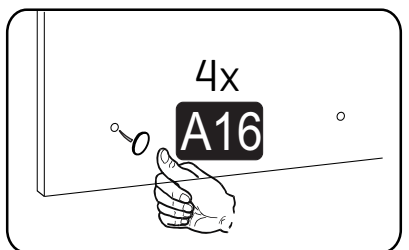

21

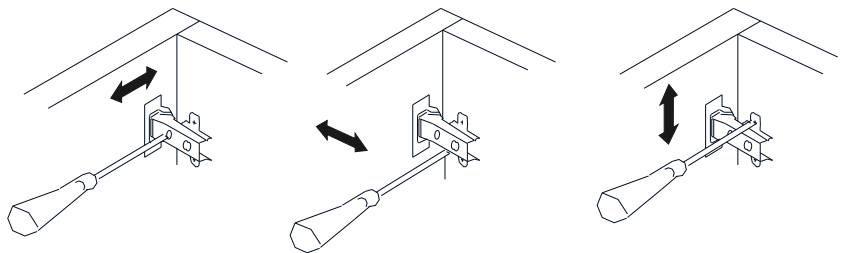
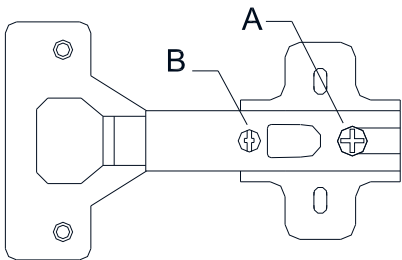
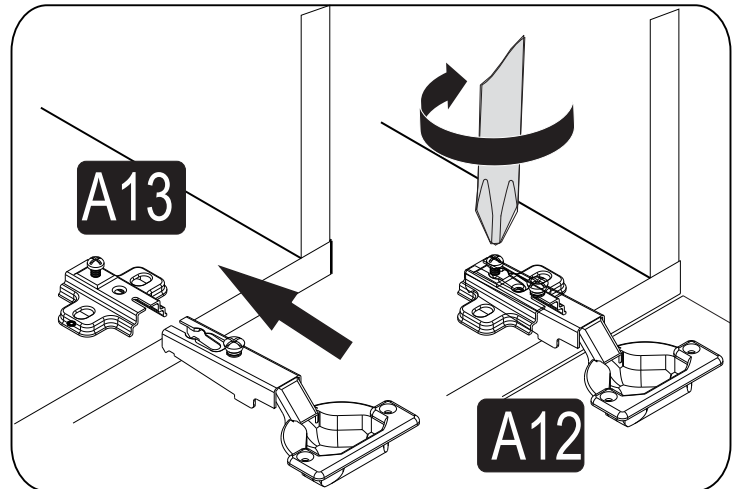
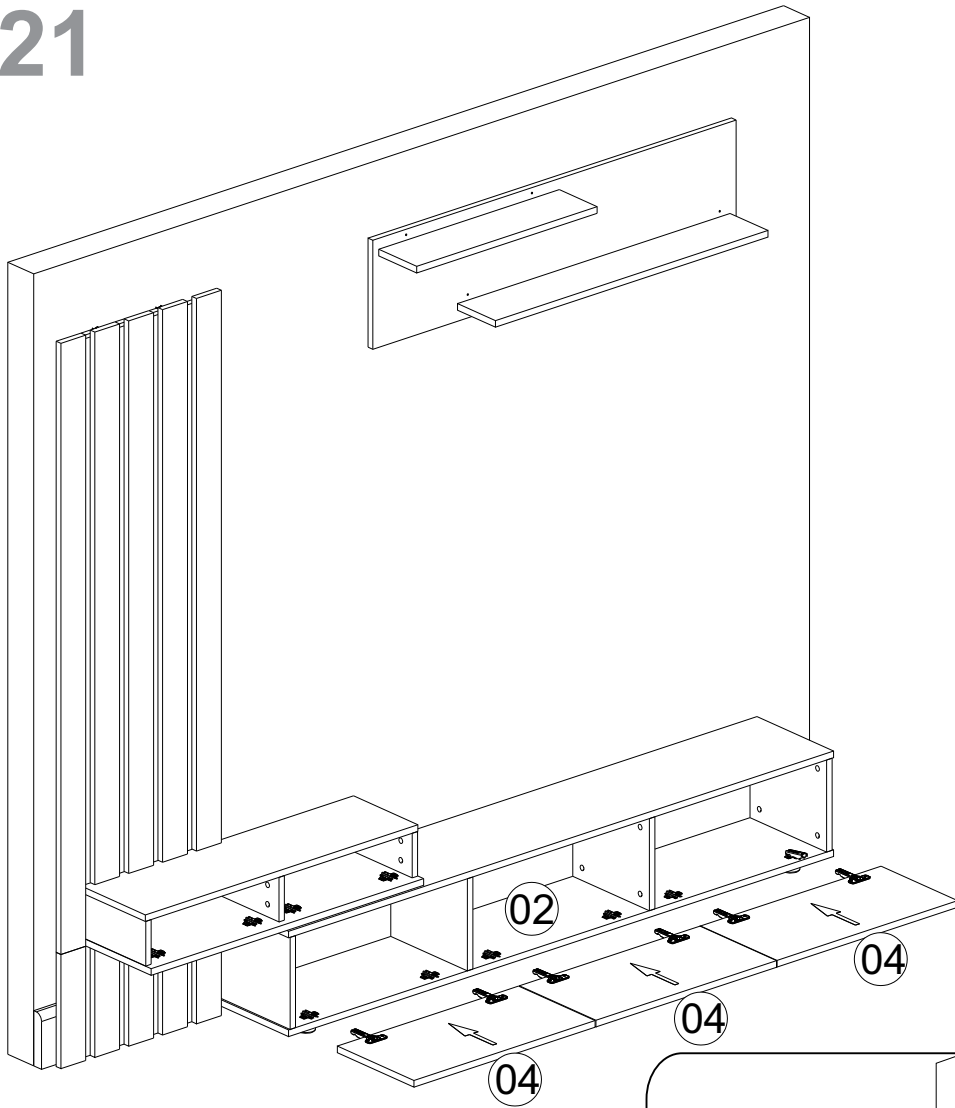

A= to connect the hinge to the door
 B= to arrange the door

arrows to show the directions for arrangement of doors.

22

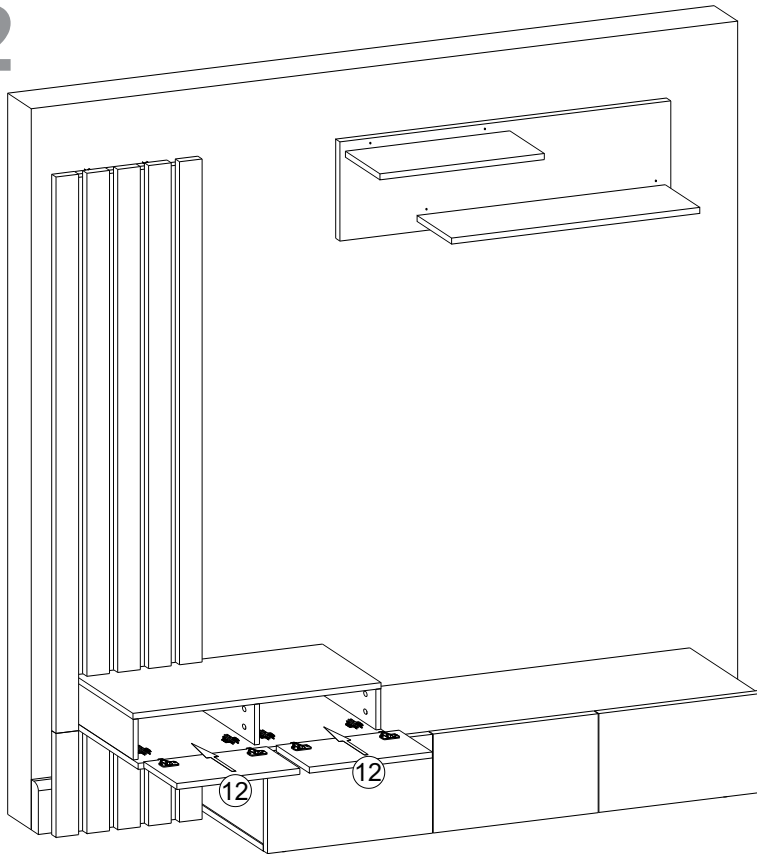

1. step

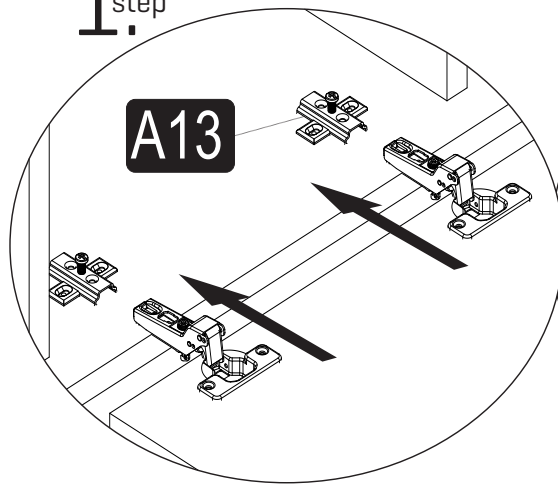

2. step

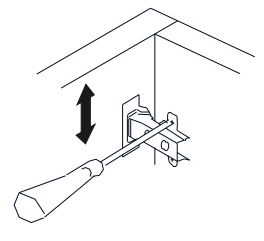
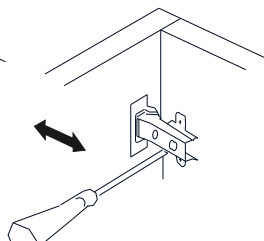
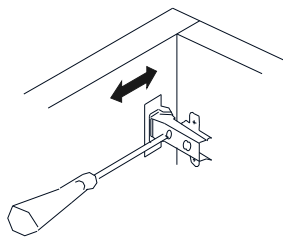
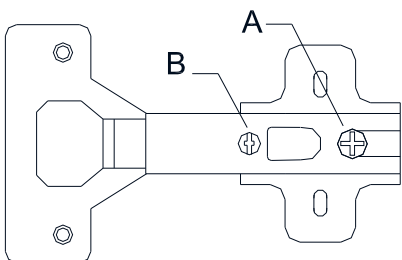
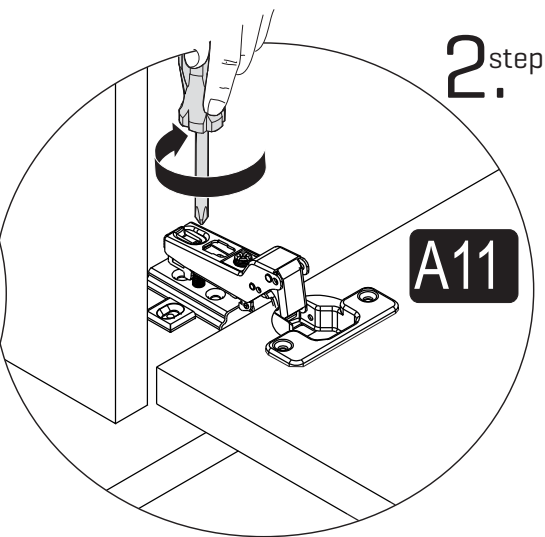

A= to connect the hinge to the door
 B= to arrange the door

arrows to show the directions for arrangement of doors.