

**GP041-0059,2**

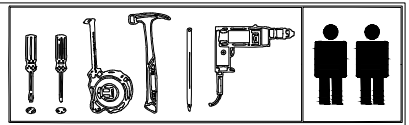



- 1/1
- (A)**
- PB  
1X
- BP1  
2X
- P2  
4X
- P1  
2X
- T1  
2X

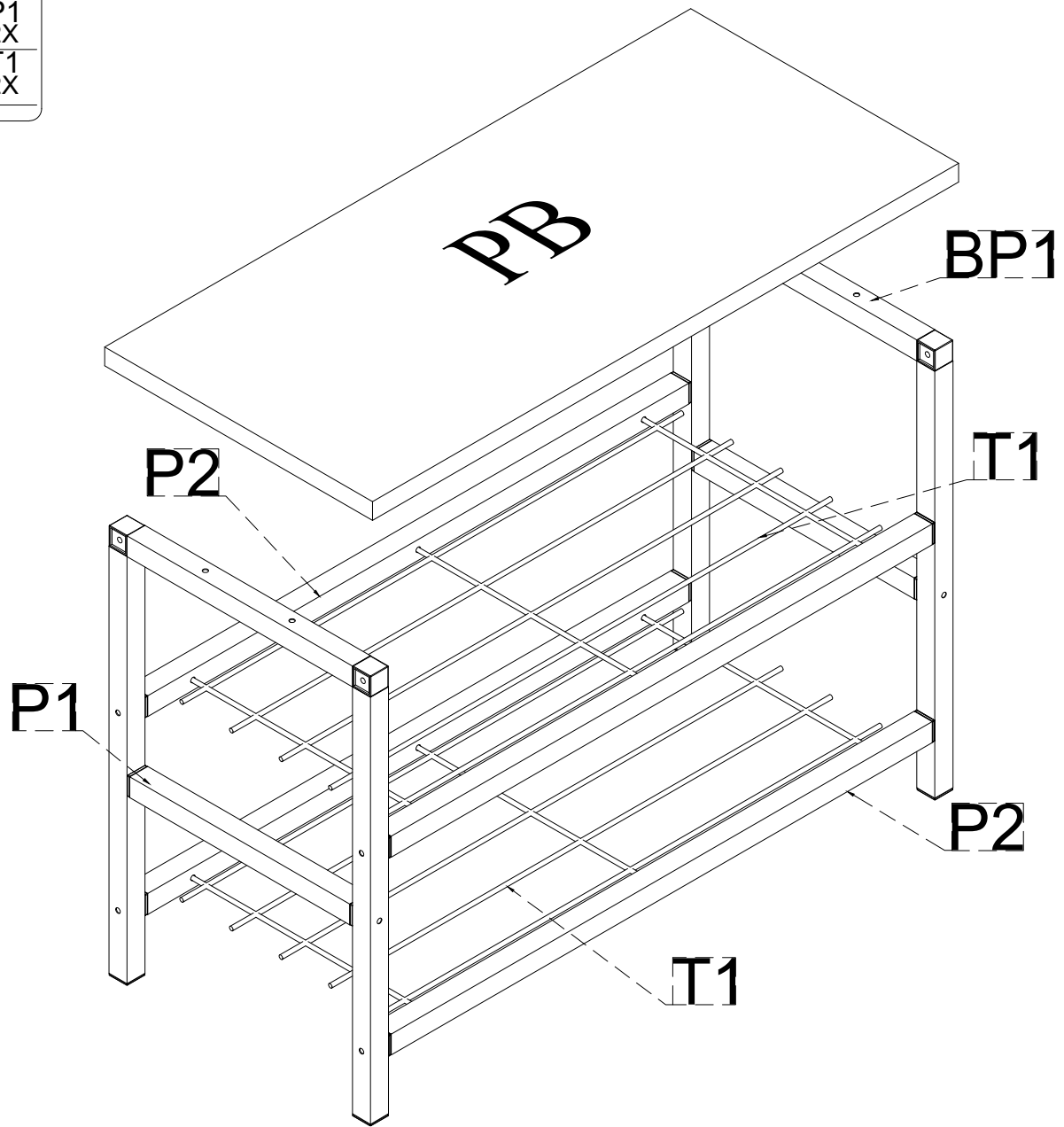

PB 650x297 mm

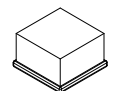

NO:H100195 5x40  <b>12 x</b>	NO:P002101 20*20  <b>04 x</b>	NO:H100045  <b>10 x</b>	NO:H100006 4x35  <b>04 x</b>				
--	---	--	--	--	--	--	--

