









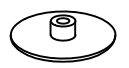

i GP052-0144,1

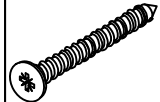
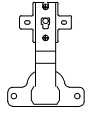
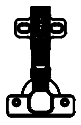

80 x 35 x 42cm

							
X 15	X 15	X 15	X 14	X 2	X 26	X 2	X 2
A	B	C	D	F	G	L	S
MINIFIX GIB	MINIFIX BODY	MIN.STOPPER	DOWEL	PLUG	3,5 x 18 SCREW	5x80 SCREW	HINGE (Crank 0)

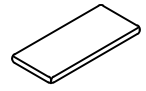
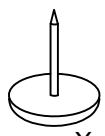
					
X 2	X 5	X 6	X 2	X 1	X 4
U	AG	AH	AK	BL	BR
HINGE(Crank 16)	HANGING	SHELF BUTTON	WALL PLUG	SPONGE LAYING	POLYGRID

NO	NAME	PIECE
1	BOTTOM PART	1 PC
2	LEFT PART	1 PC
3	MIDDLE PART	1 PC
4	MIDDLE PART	1 PC
5	RIGHT PART	1 PC
6	BACK PART	1 PC
7	TOP PART/COVER	1 PC
8	SHELF	1 PC
9	WALL SHELF	1 PC
10	WALL PANEL	1 PC
11	COVER PART	1 PC
12	BACK PART	1 PC

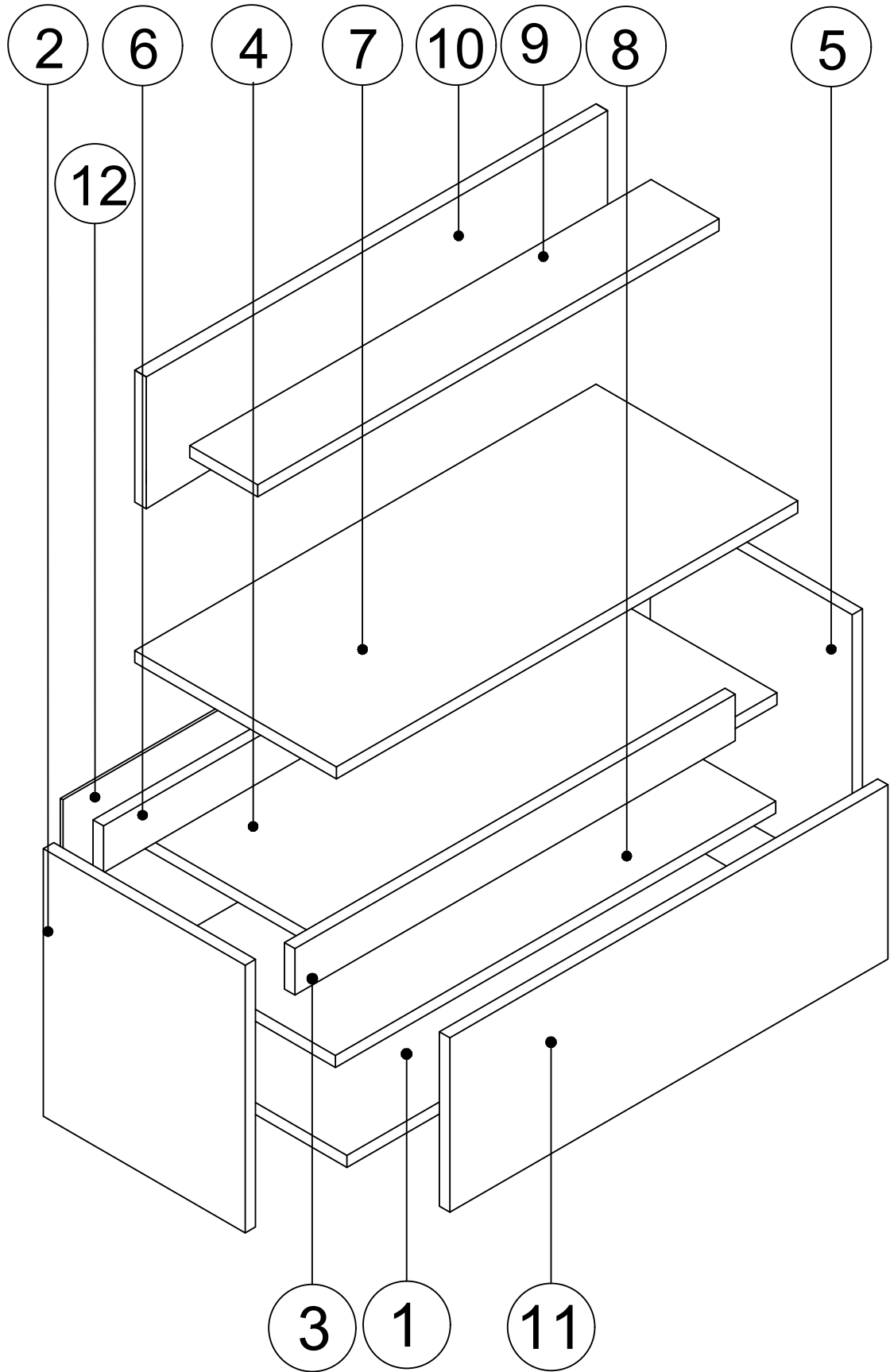

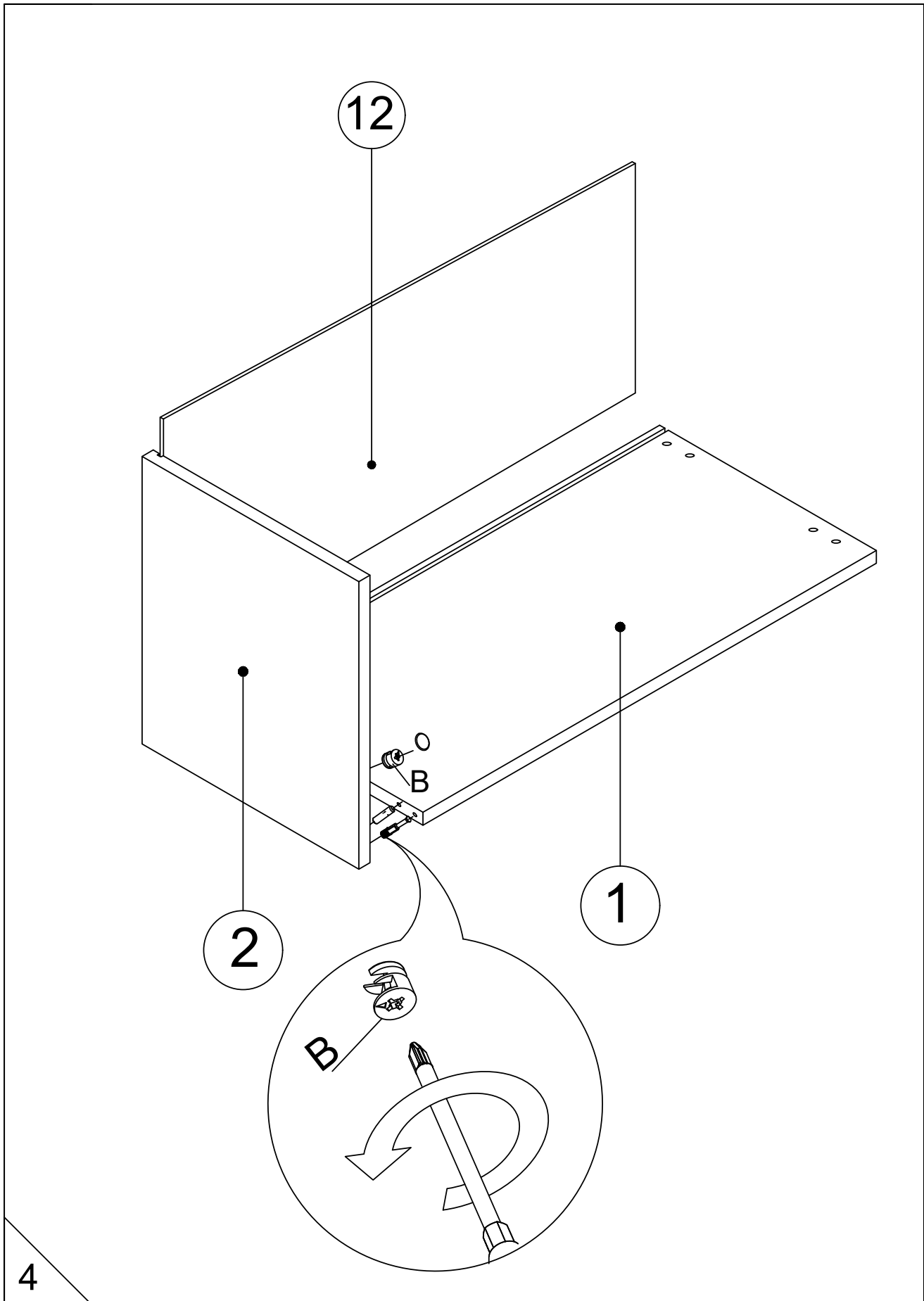

12

2

1

B

4

4

