

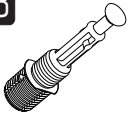





i GP052-0158,1

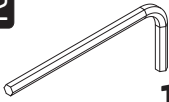

23,2 x 22 x 59,6cm

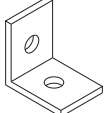
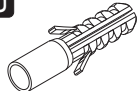
A23 Minifix M8  12x	A22 Minifix G18  12x	A04 KVLV  12x	A12 ALYN  4 SW 1x	A18 3,5x18  4x
A15 LA  RNK1 4x	A16 DBL 8mm  4x	A17 4x50  4x	A06 18 mm  R1 12x	

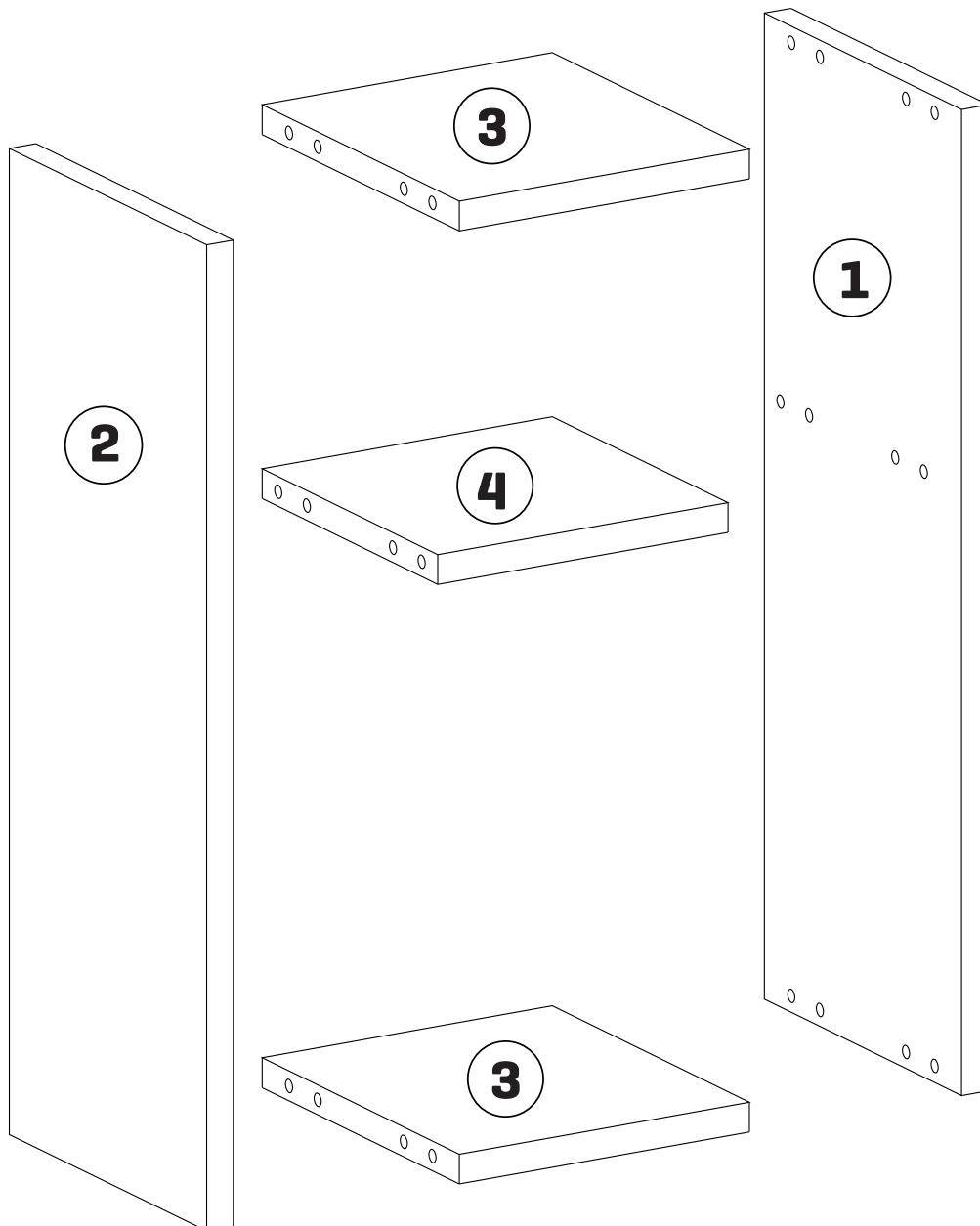

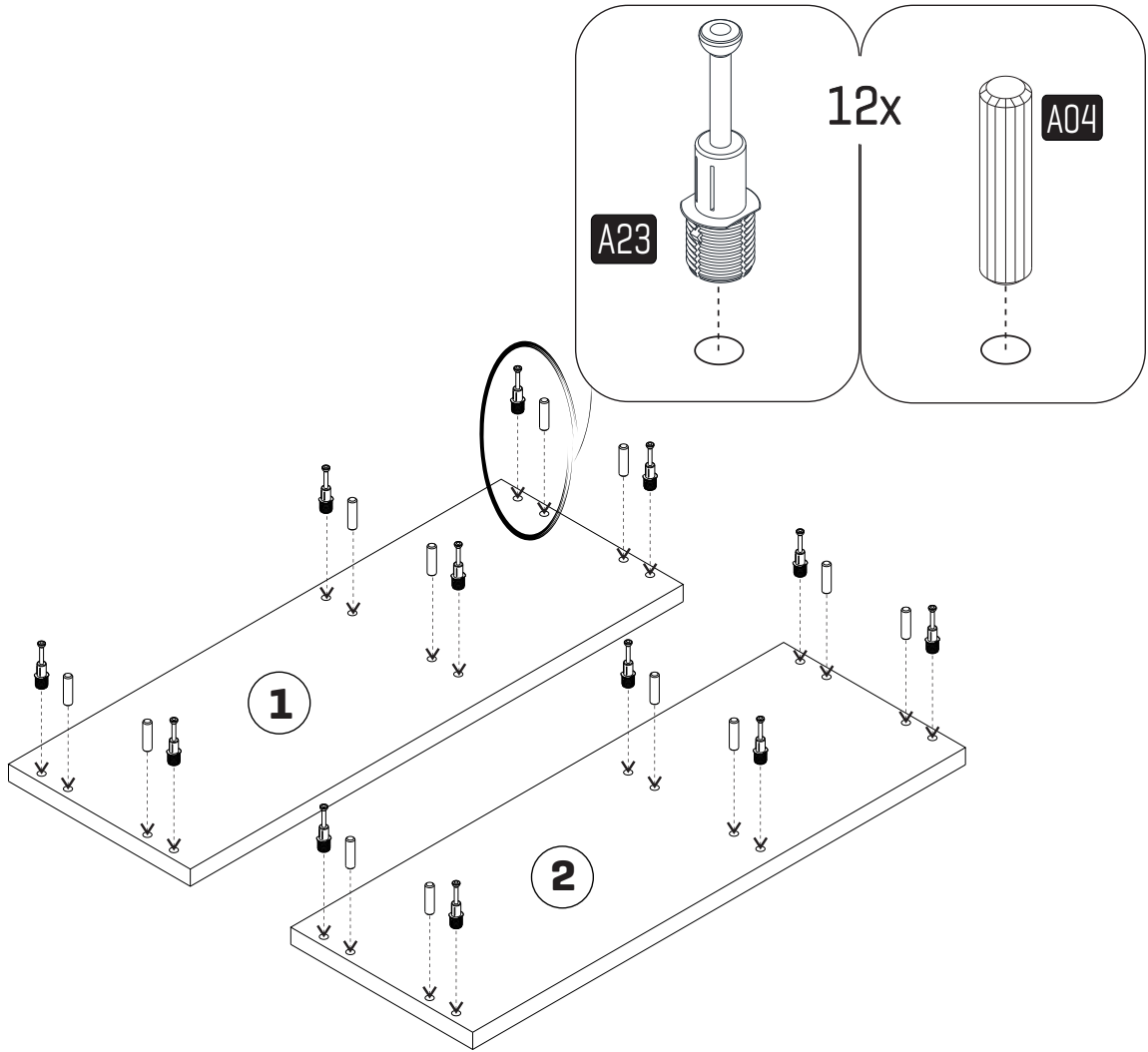

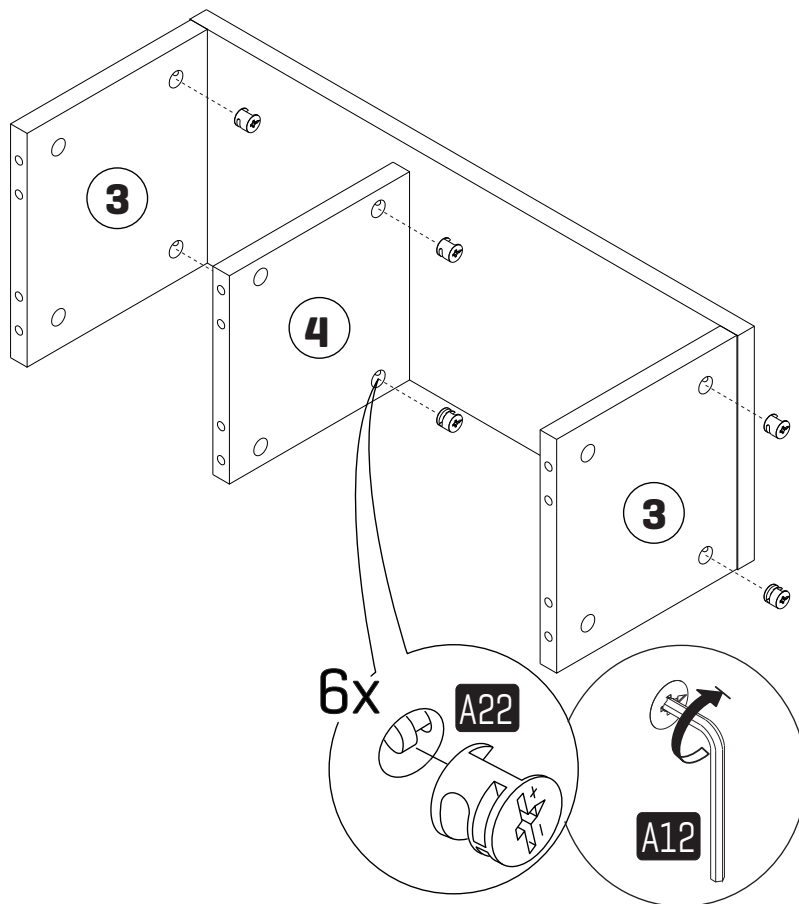
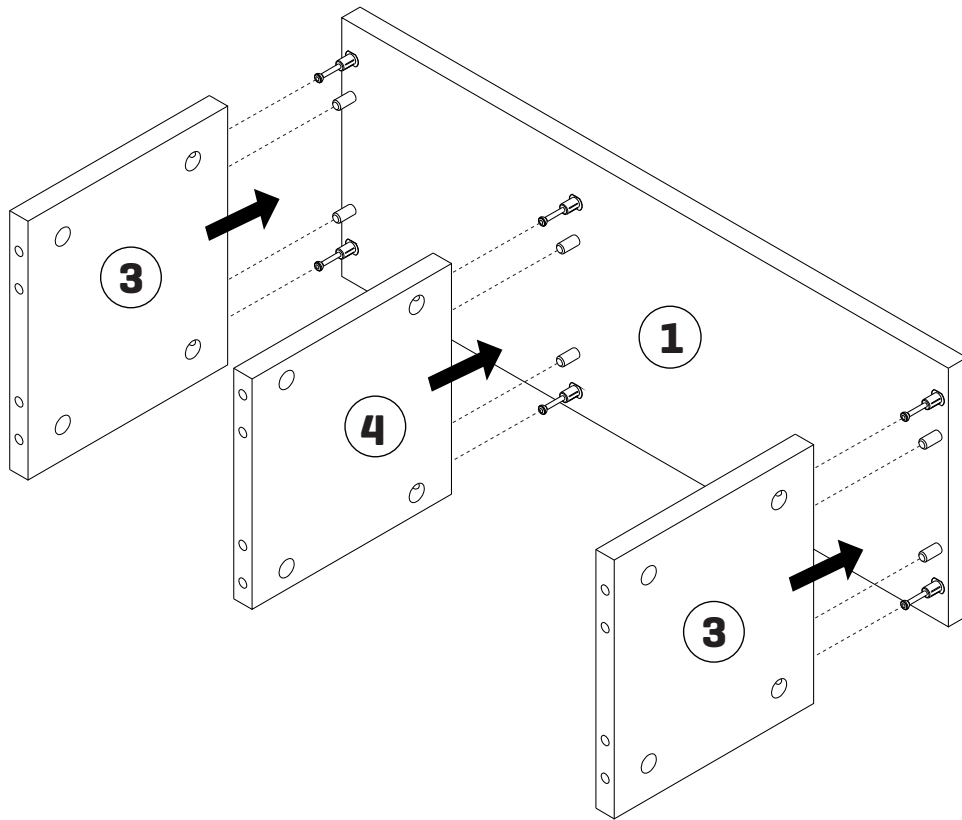

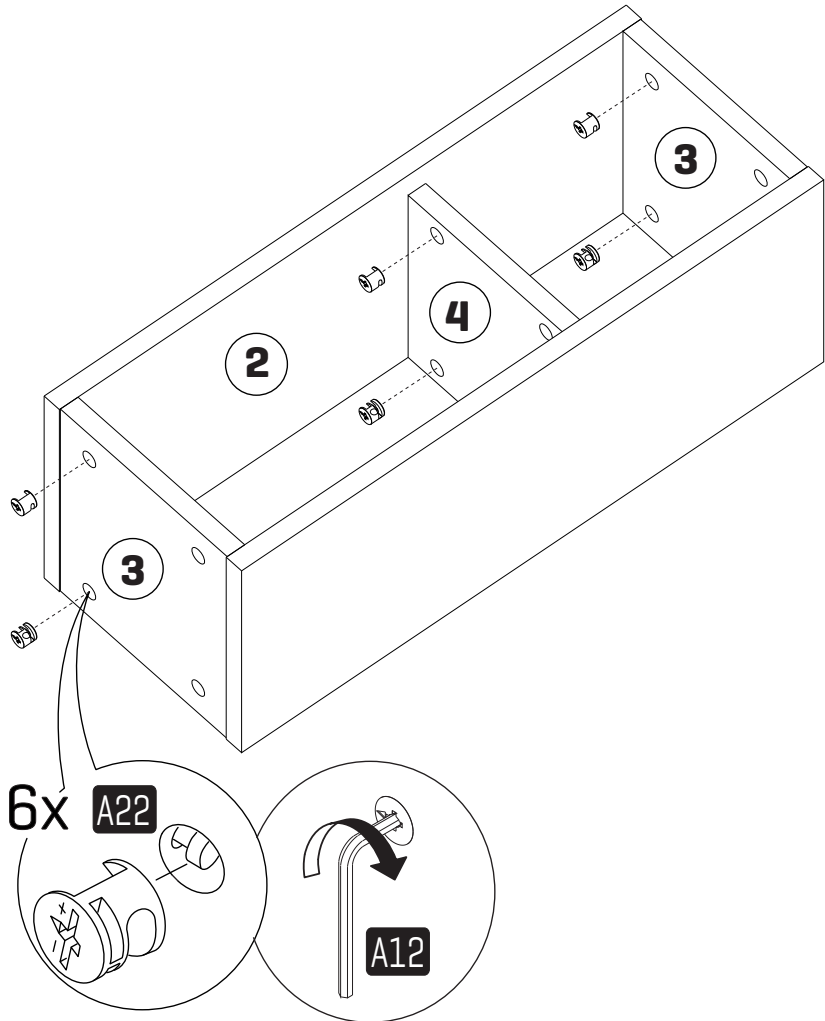
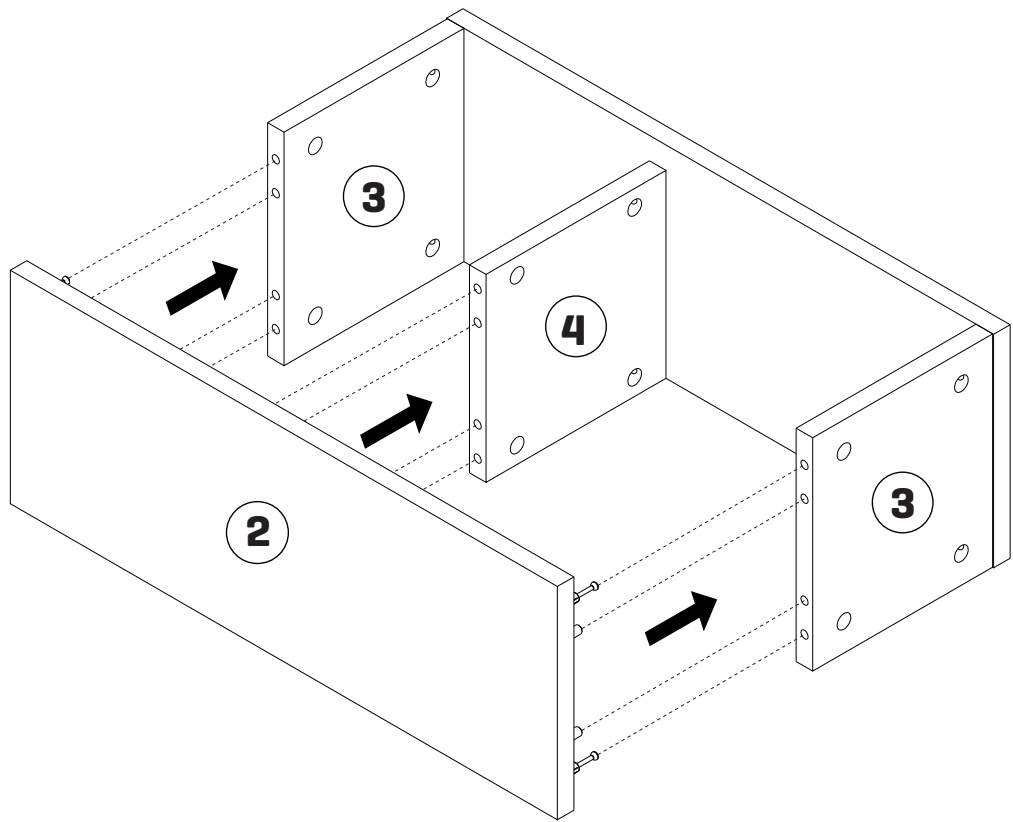

WALL

SPIRIT LEVEL

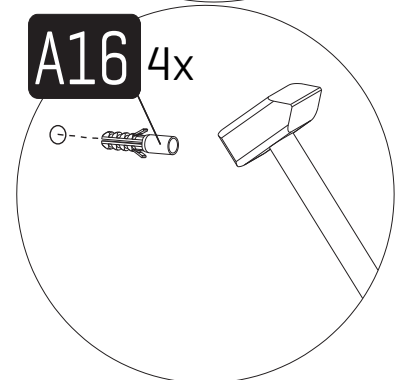
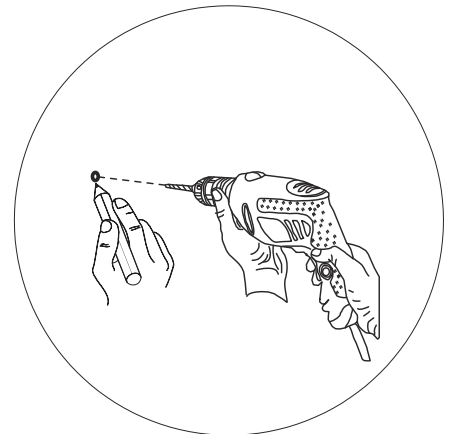
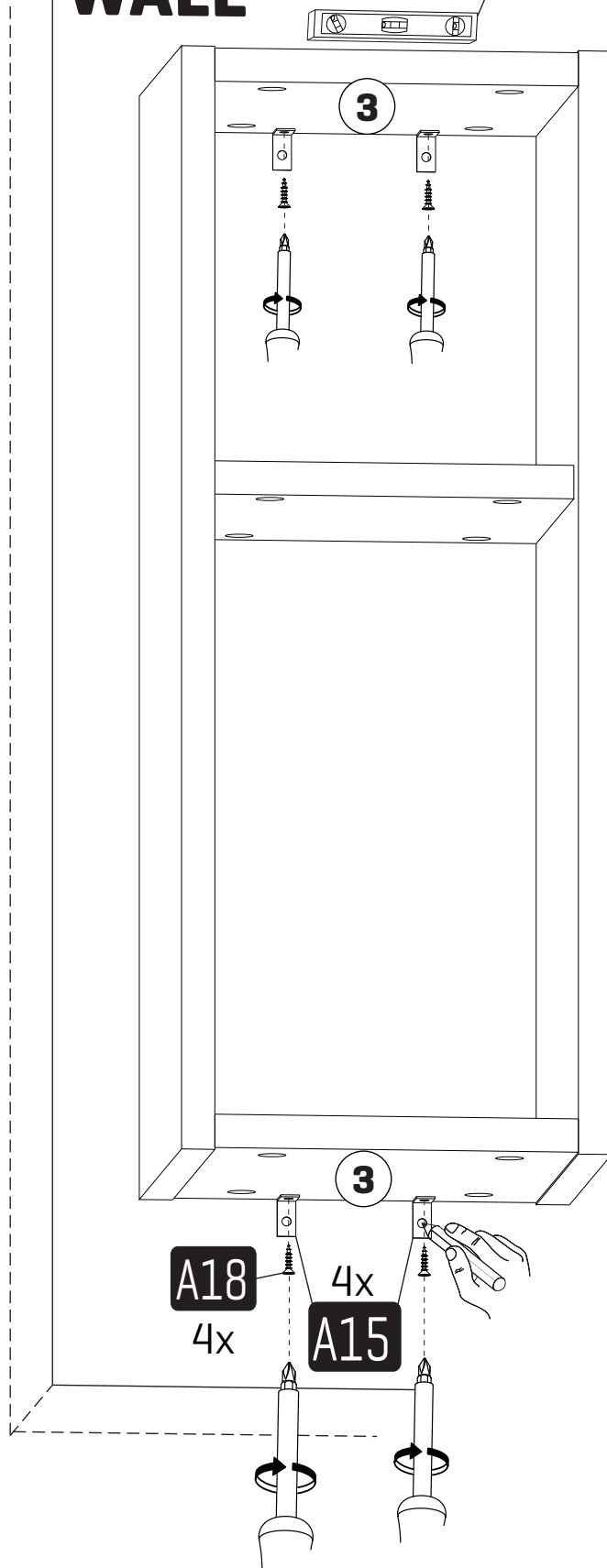

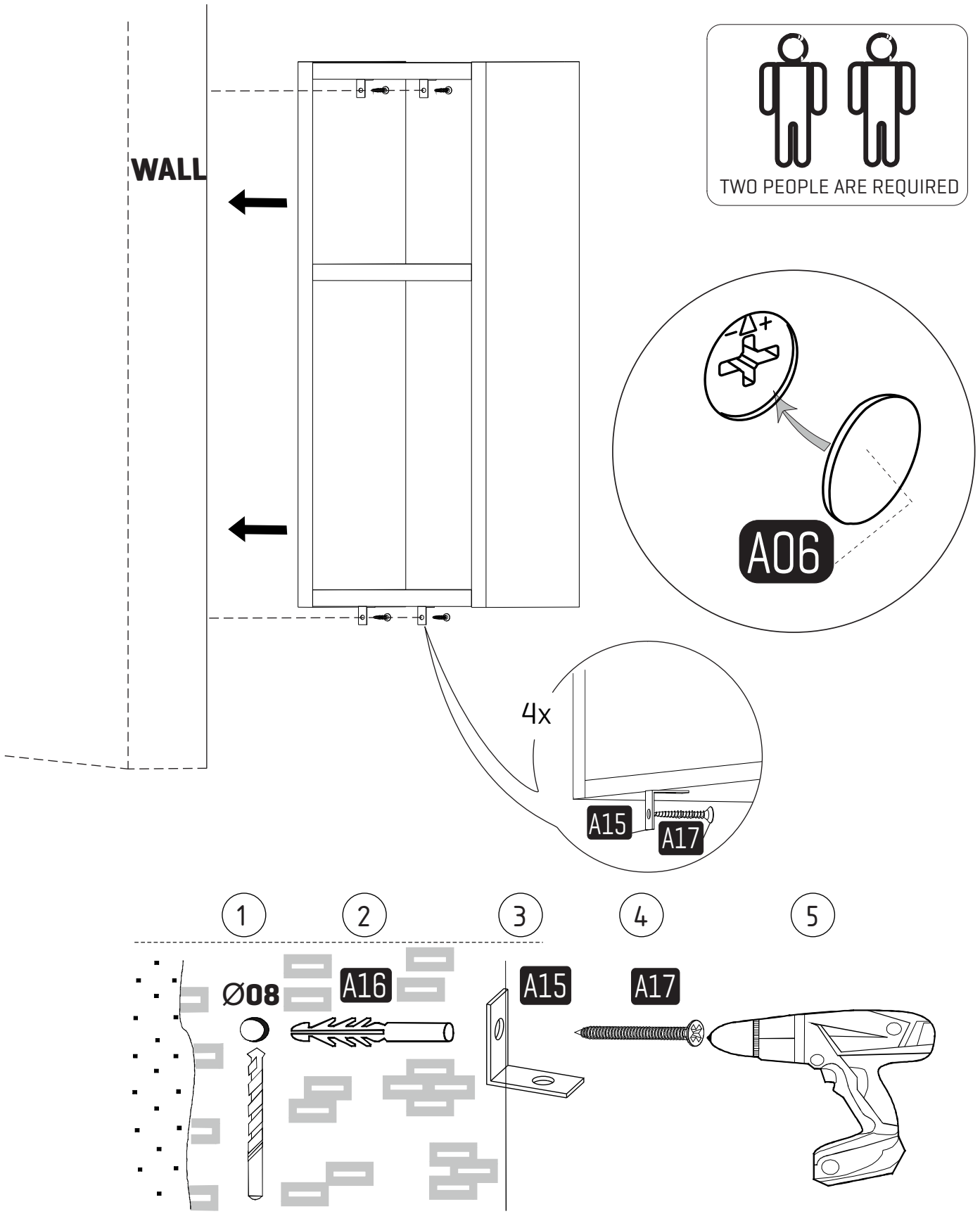

Check the wall type before installation of dowel. Wall is drilled with equal diameter of dowel. [08mm] Universal Plastic Dowel provides the general purpose usage. Requires two stages assembly. Dowel can be different type according to the wall type. [E.g. Plaster sheet partition wall, gas concrete, hollow brick wall]. If required, use appropriate dowels and screws.