

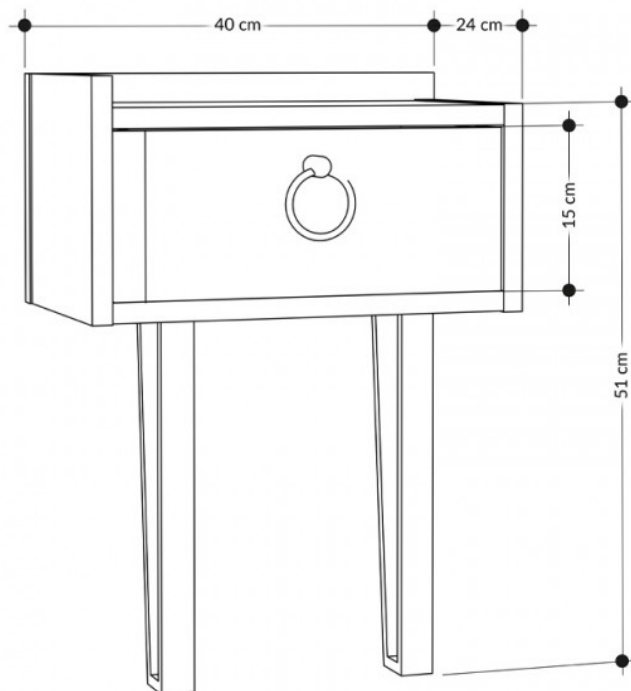









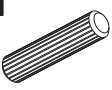



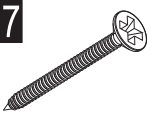

GP037-0167,3



A22 Minifix k18  16x	A23 Minifix M10  16x	A04 Ø8  4x	A12 Allen  1x	A06 18mm  20x
A13 50mm  4x	Z07 4x22kv  1x	Z53 Shk1  1x	A17 4X50  2x	A16 DbØ8  2x
Z54 Pp1501  2x	B15 15 (black)mm  4x	Z61 30x10x300  2x	A69 P.D.  4x	

SPONGE NIGHTSTAND LEFT

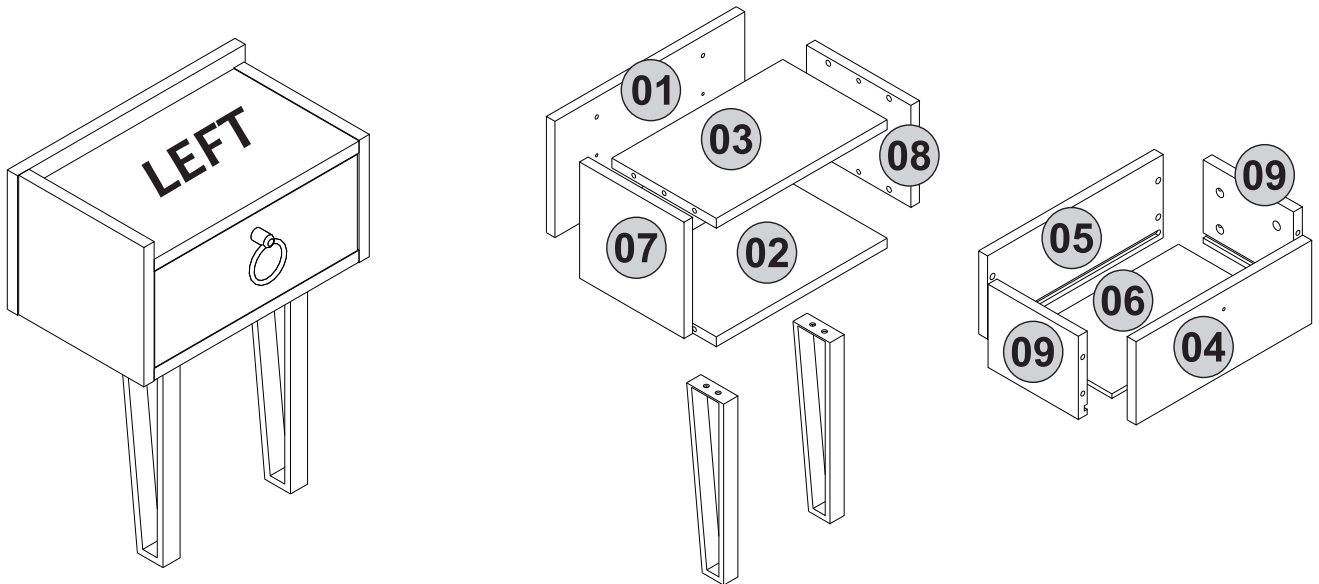

SPONGE NIGHTSTAND RIGHT

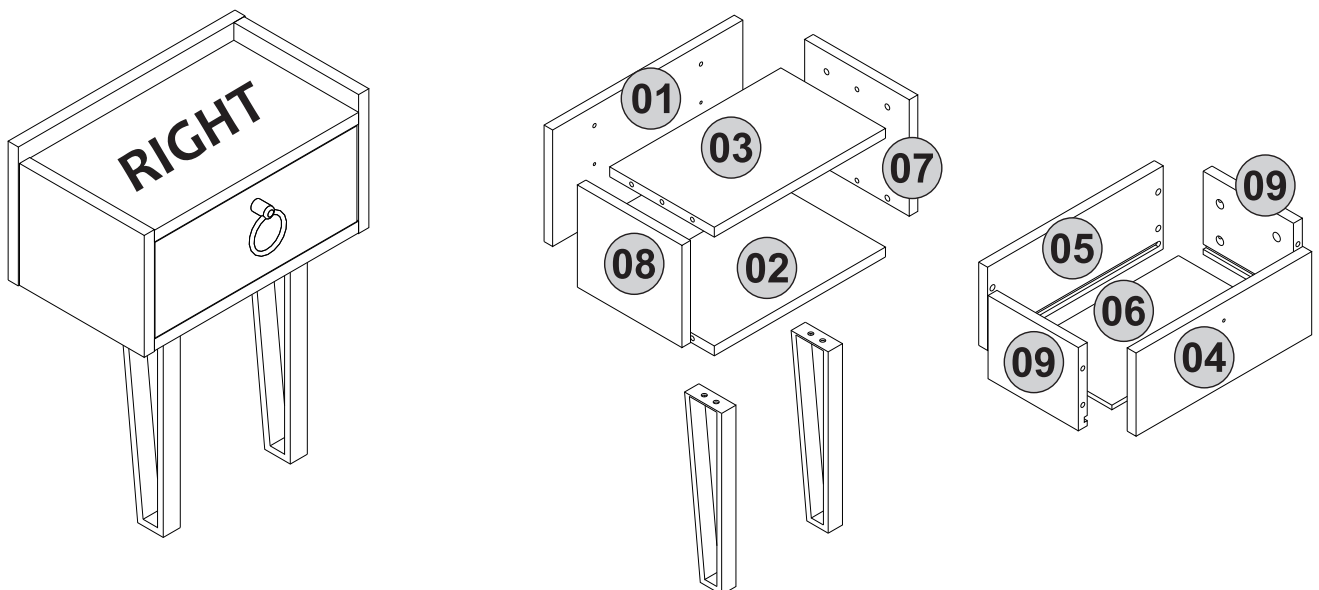

1. step

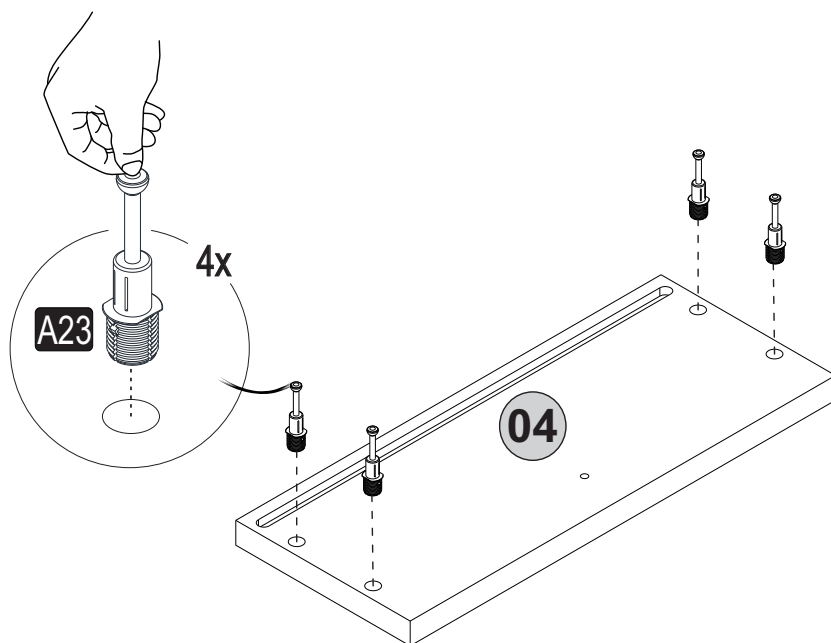

2. step

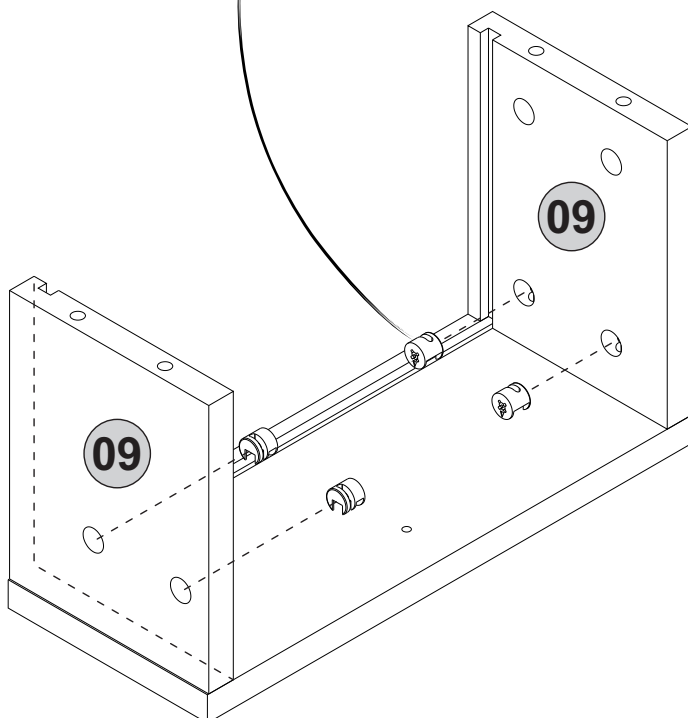
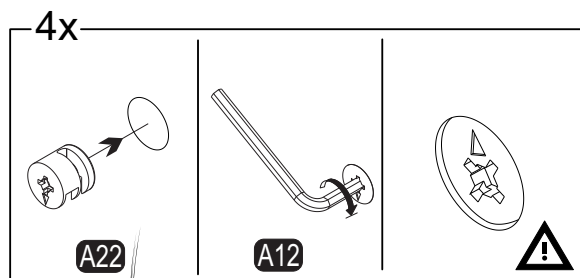
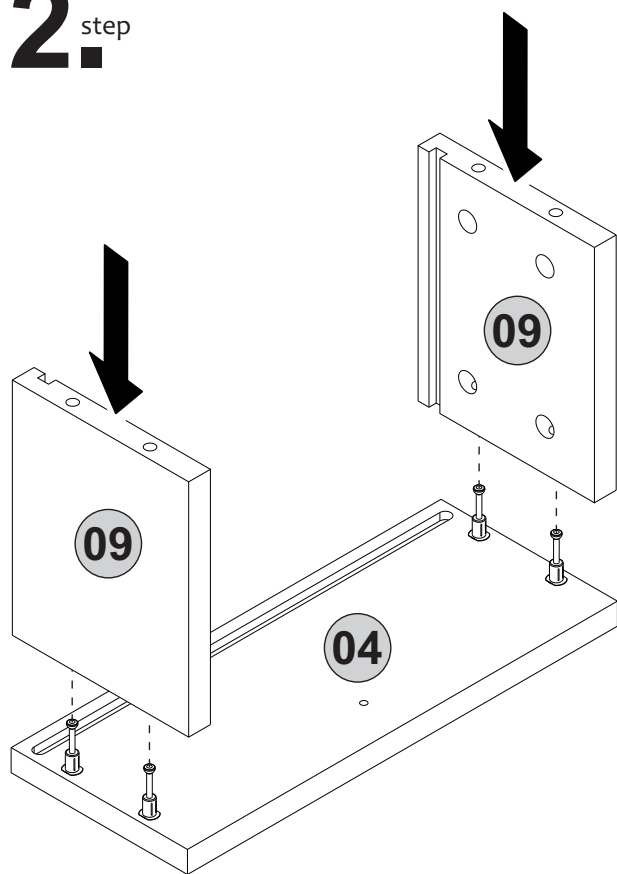

3. step

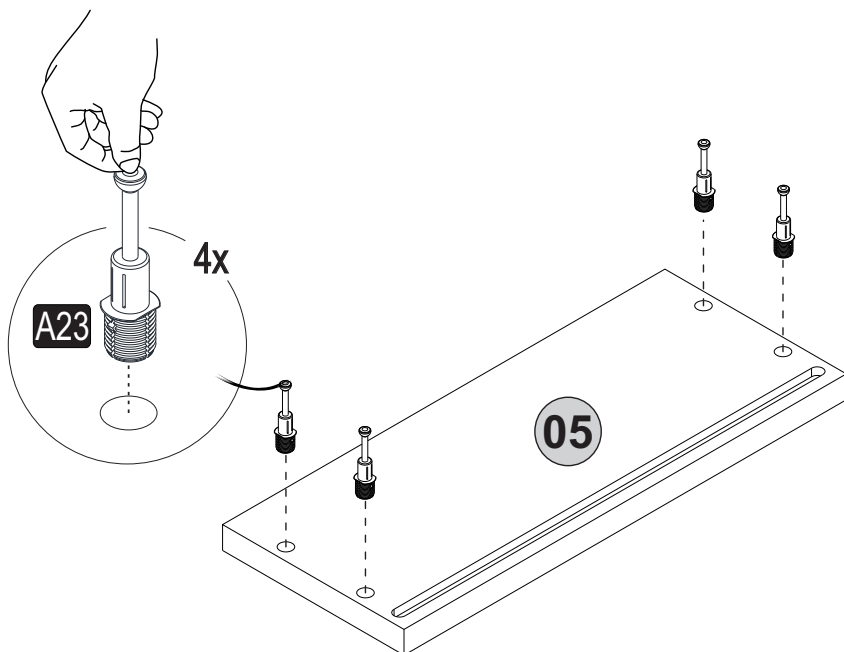

4. step

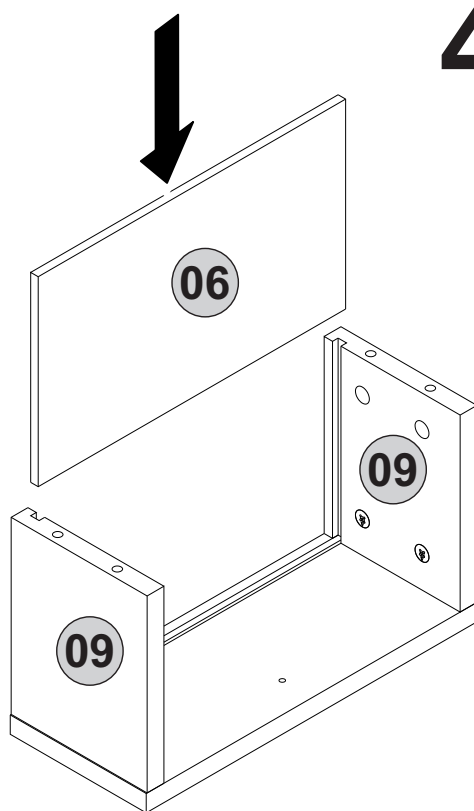

5. step

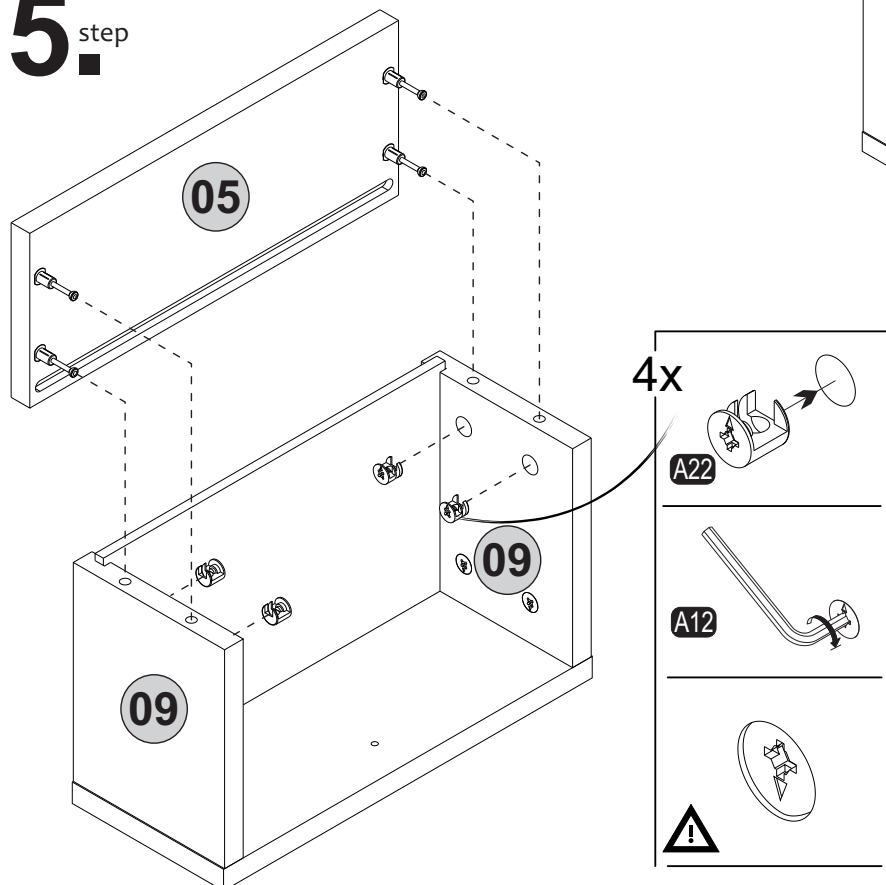

6. step

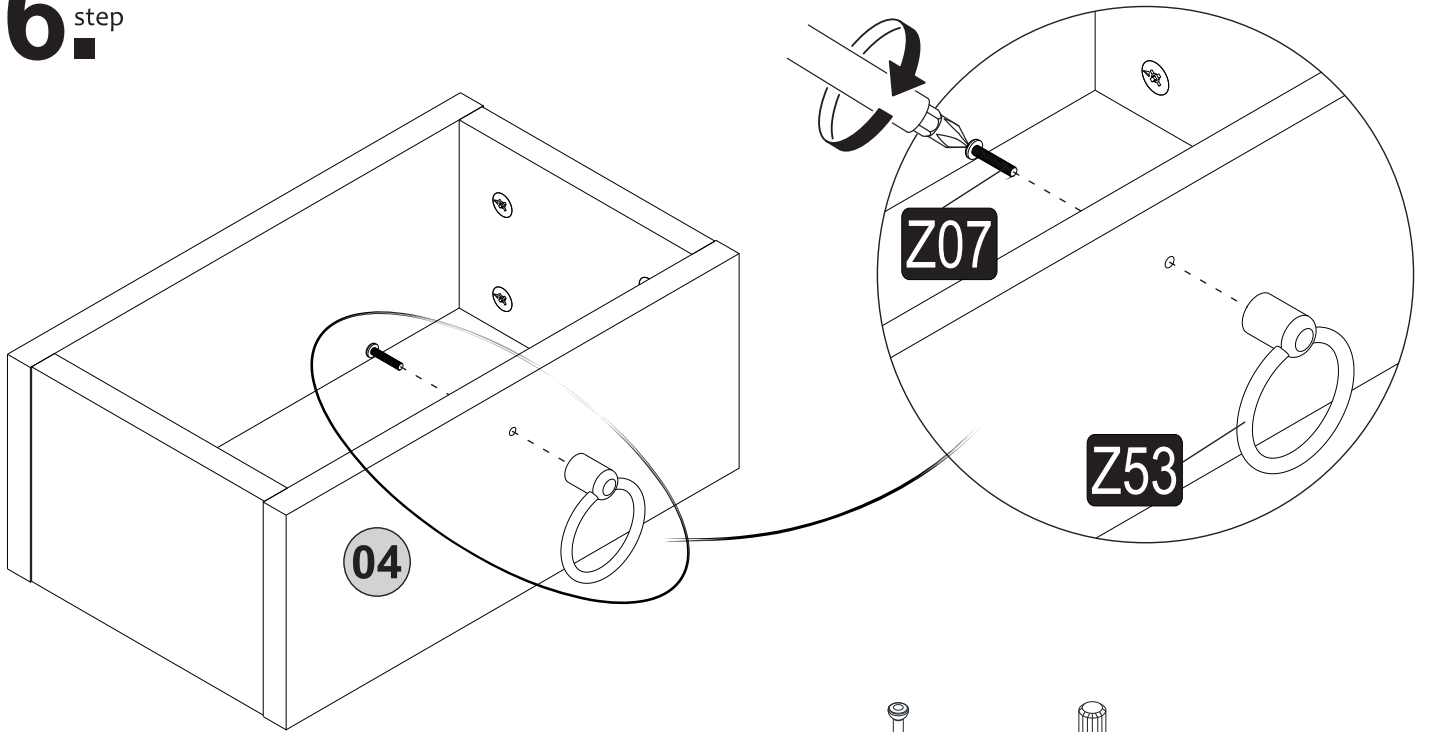

7. step

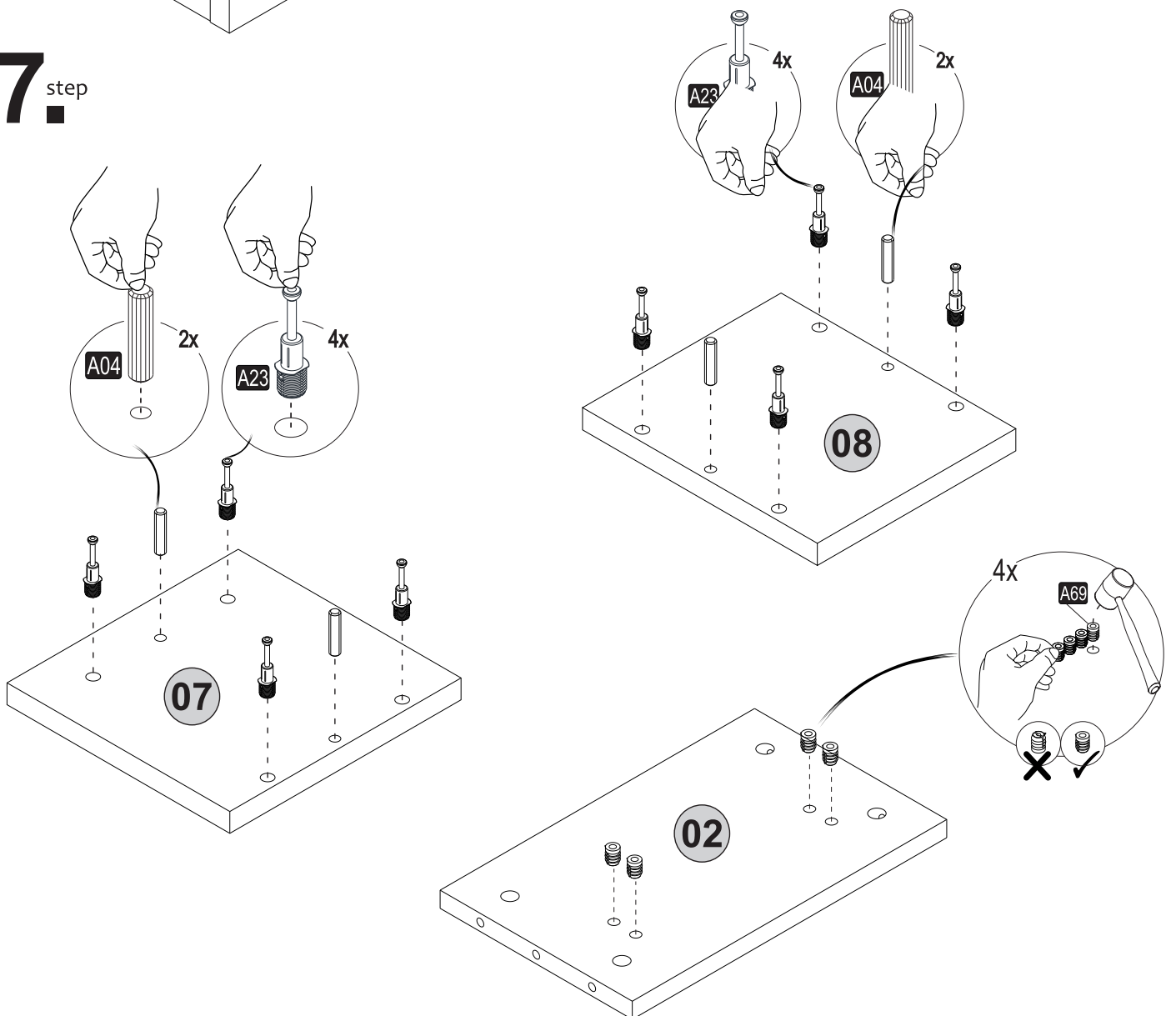

8 step

SPONGE NIGHTSTAND LEFT

(FOR THE RIGHT NIGHTSTAND GO TO PAGE 13th)

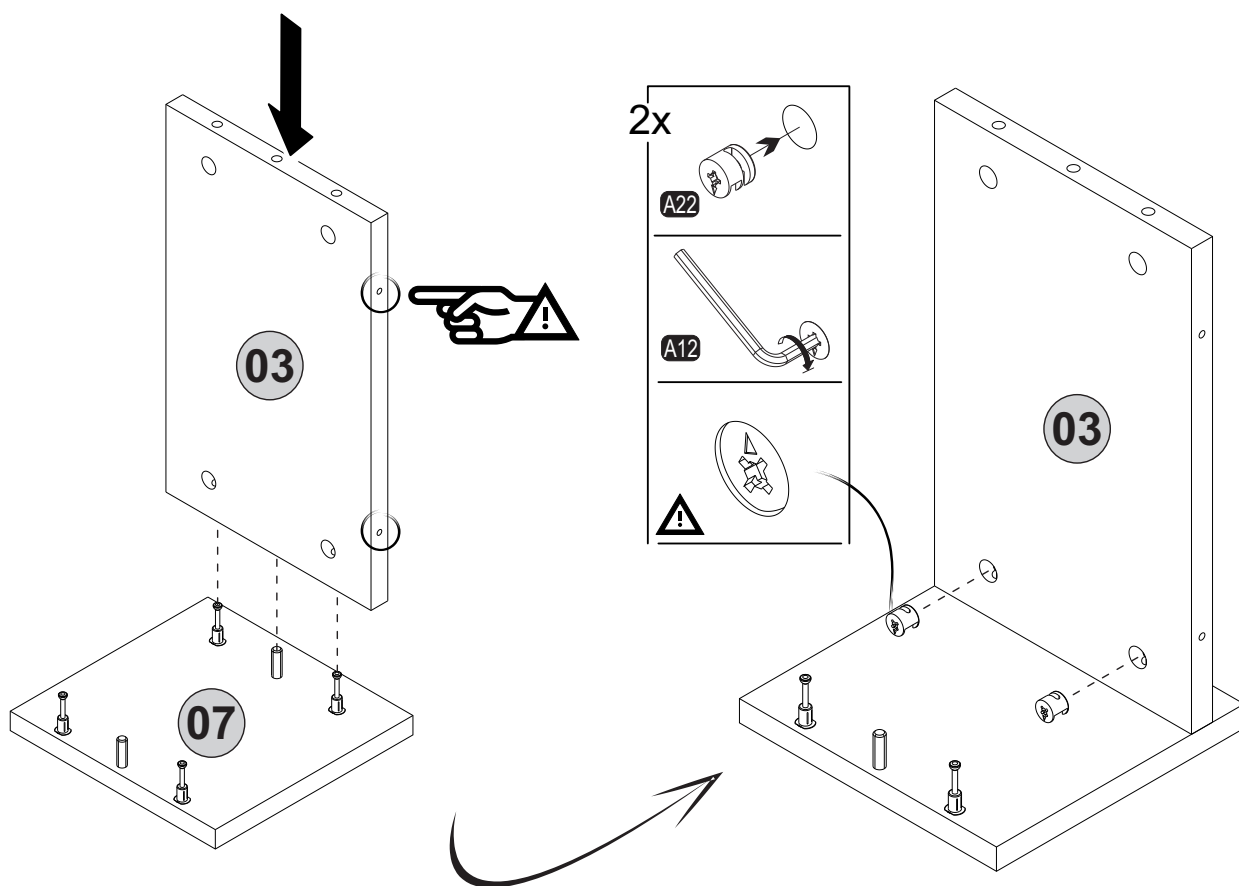

9 step

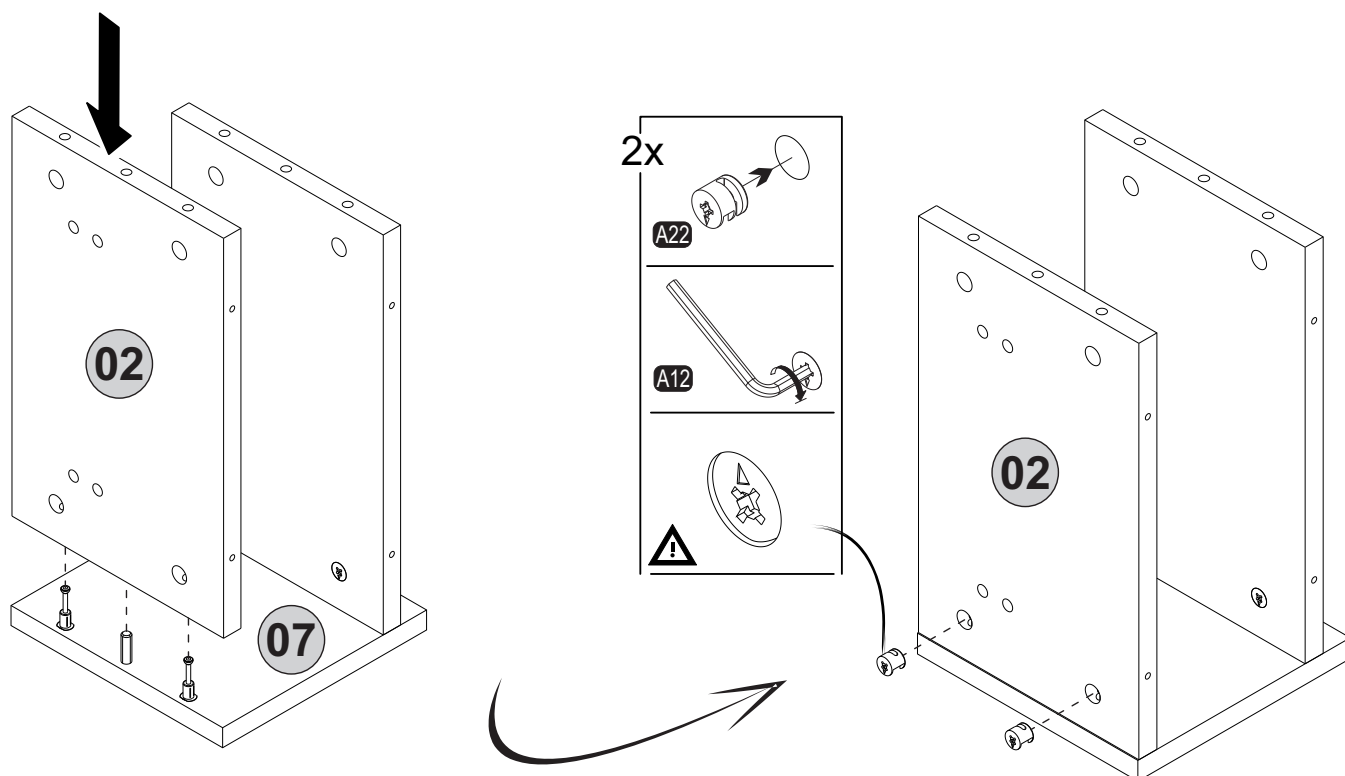

10._{step}

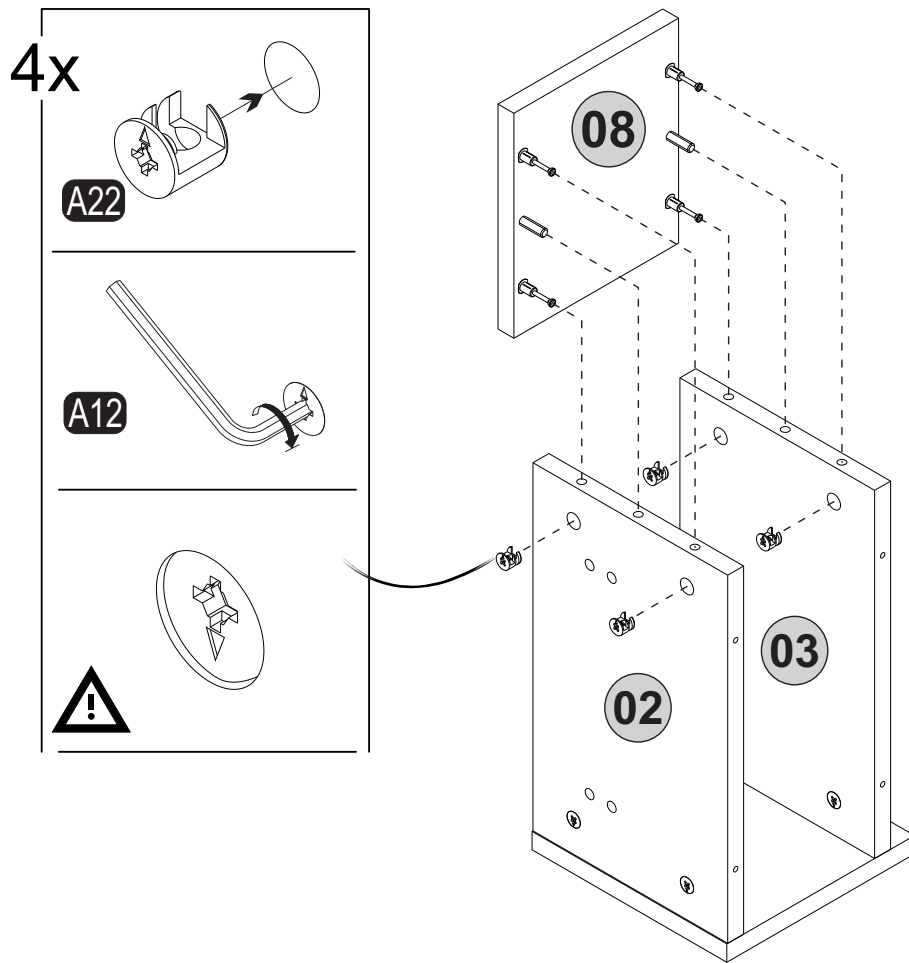

11._{step}

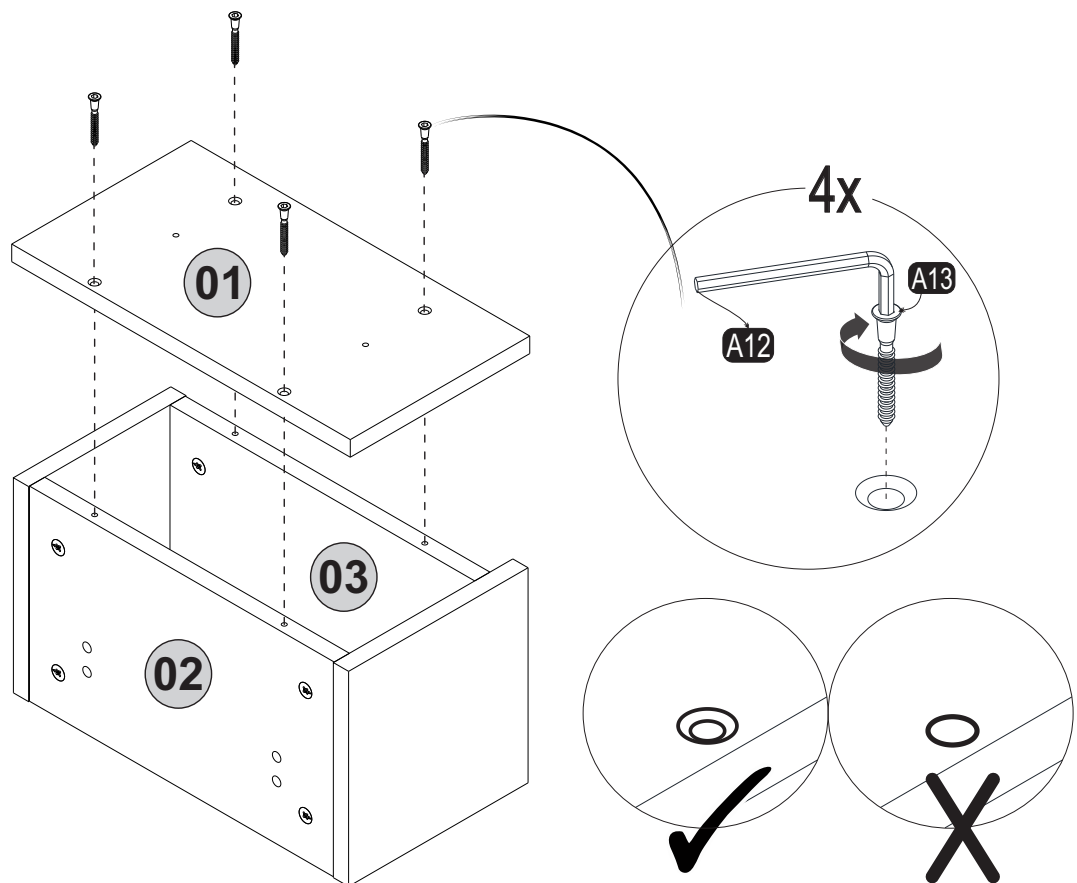

12.^{step}

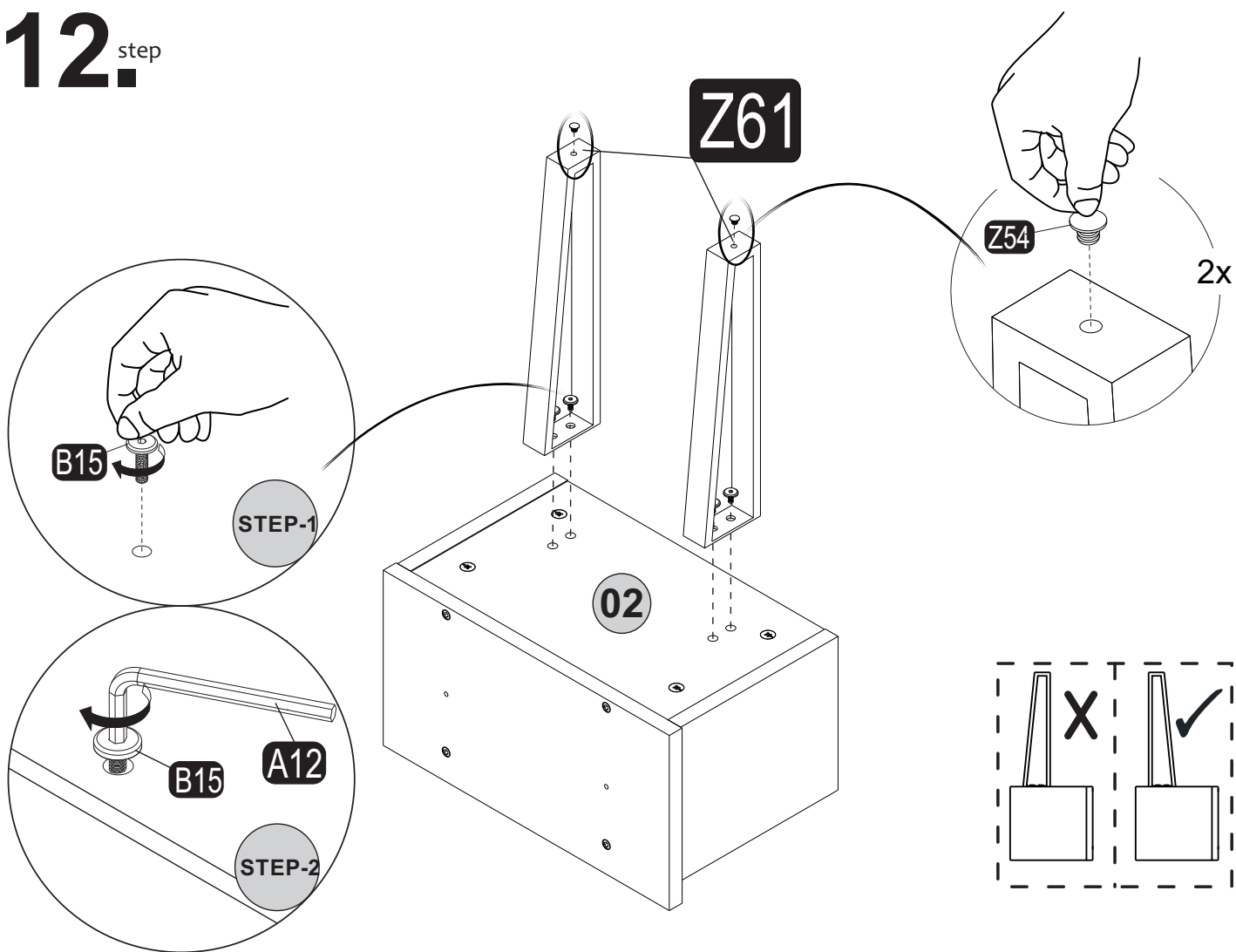

13.^{step}

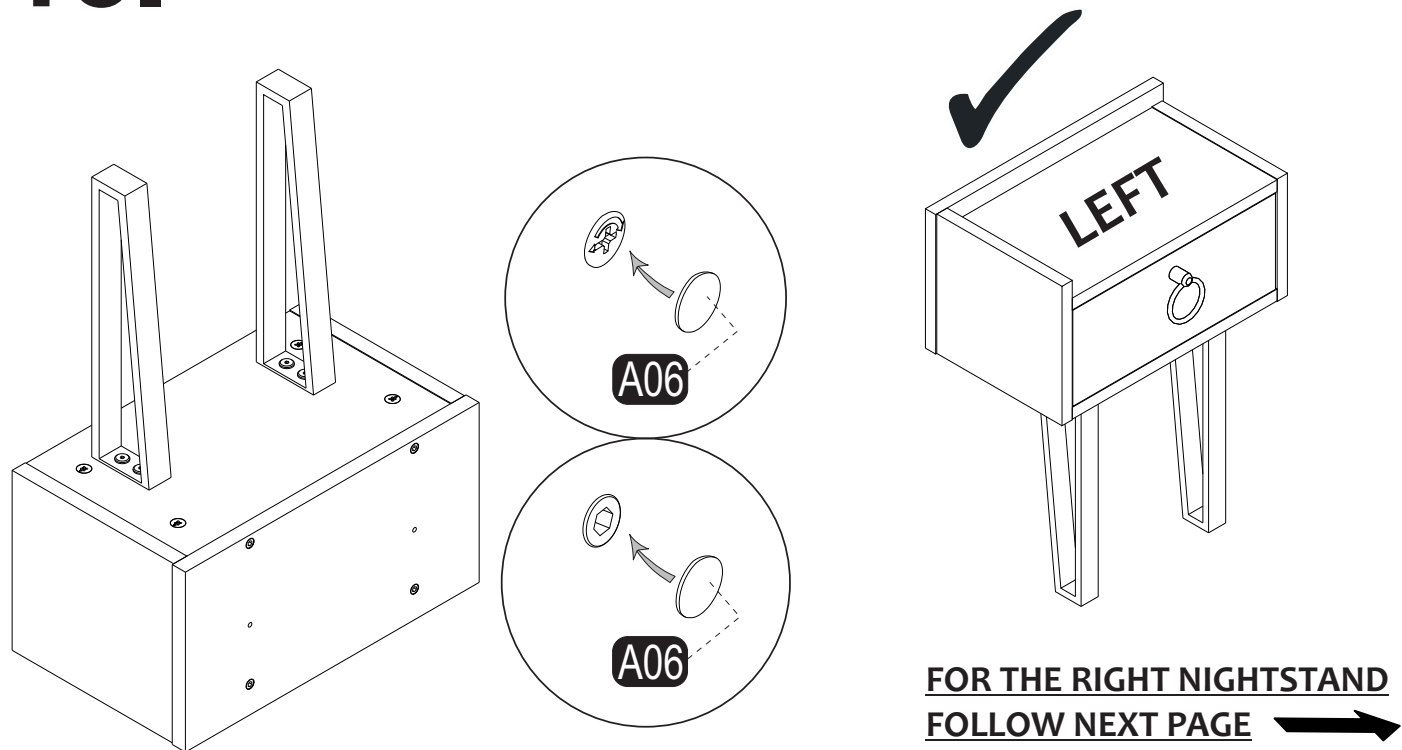

14.^{step}

14.1

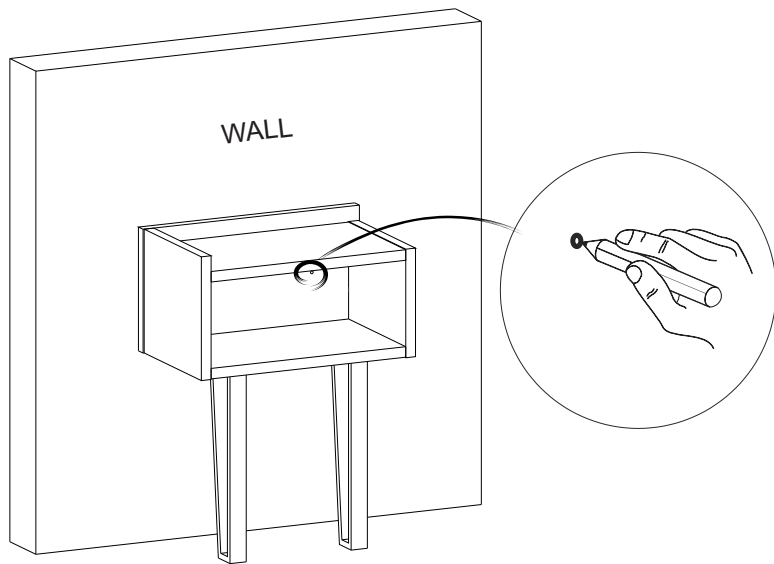

14.2

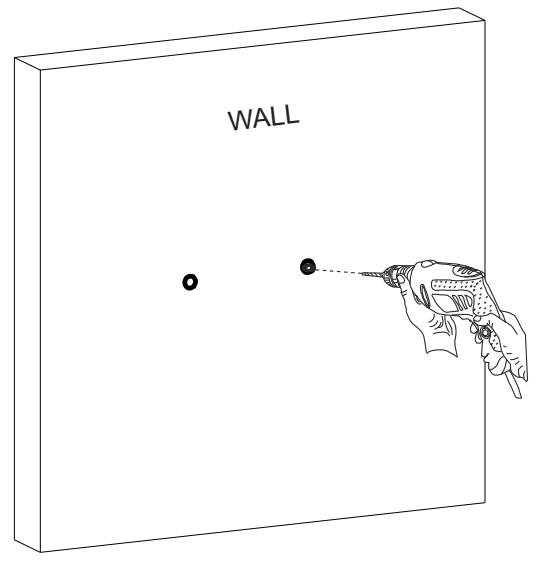

14.3

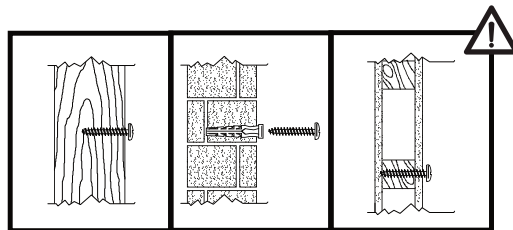

14.4

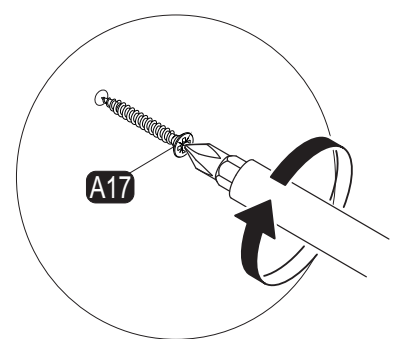
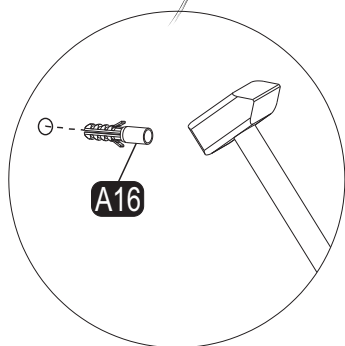
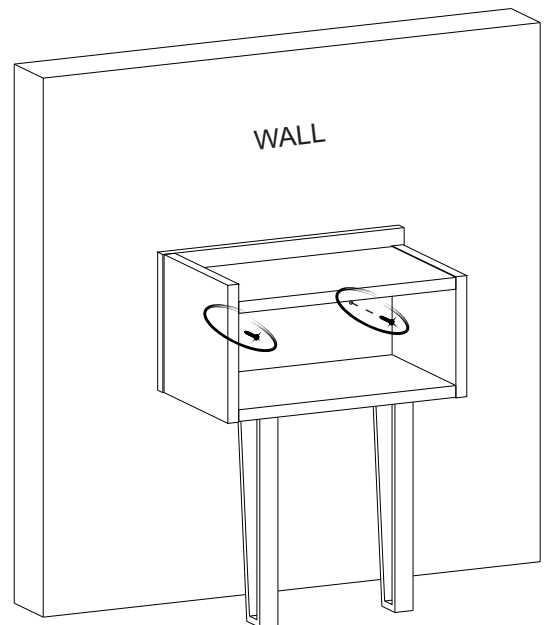
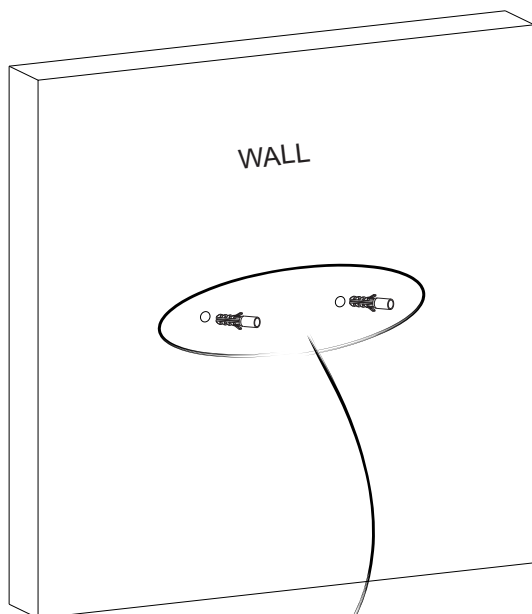

15.^{step}

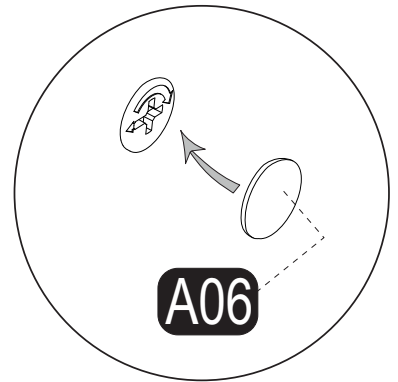
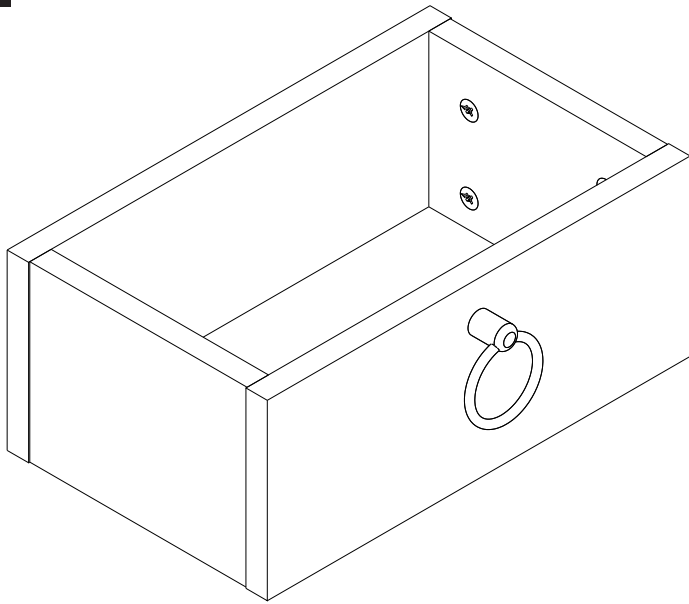

16.^{step}

