

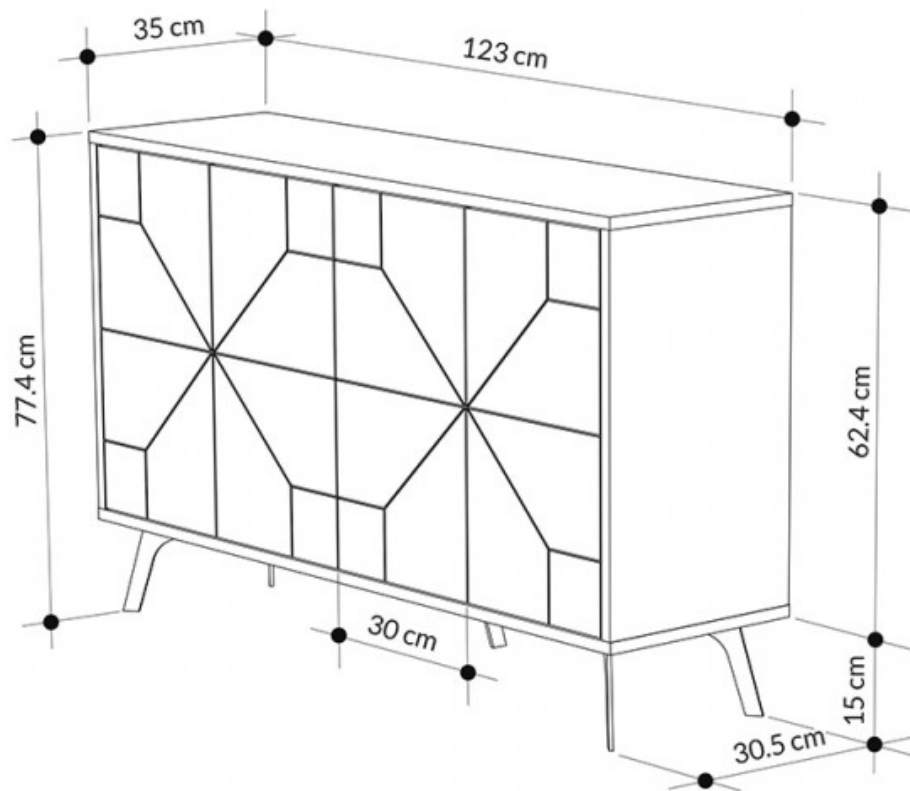









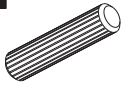

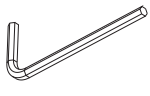
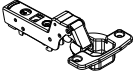
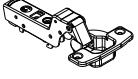
i GP037-0008,2

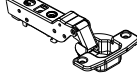

A22 Minifix k18  10x	A23 Minifix M10  10x	A04 Ø8  10x	A13 50mm  10x	A12 4 SW  1x
C19 SdbF(S)  2x	C16 Sdb(S)  2x	C18 YdbF(S)  2x	C15 Ydb(S)  2x	C20 Mtk(S)  8x
A18 3,5x18  64x	B15 15 (black)mm  15x	A69 P.D.  15x	A06 18mm  10x	A25 ARK.PL  16x
Z72  5x	A48 Raf Pimi  16x	A80 bas ac  4x		

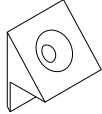
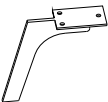
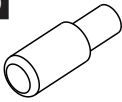
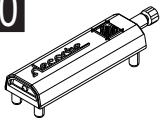
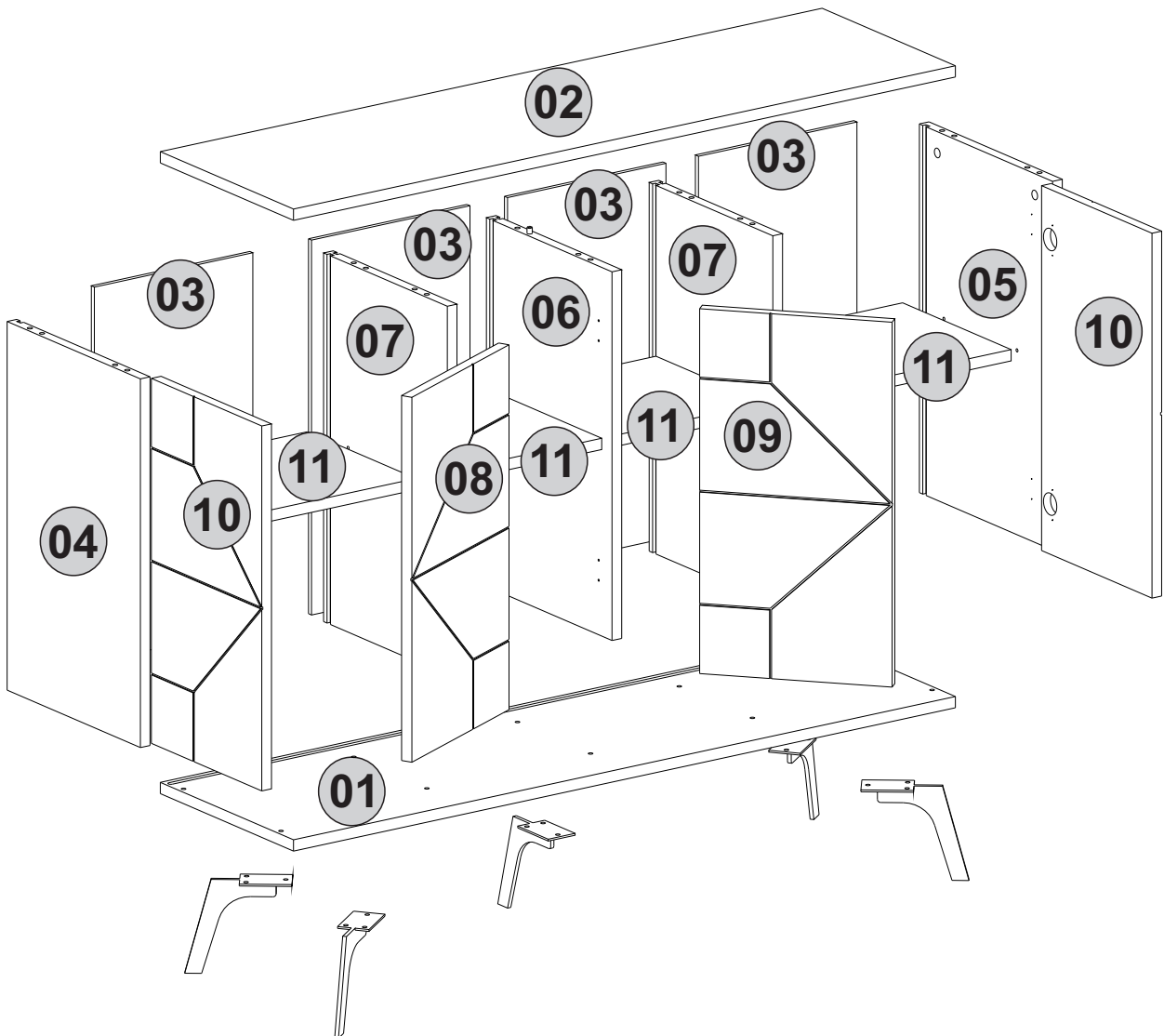

1. step

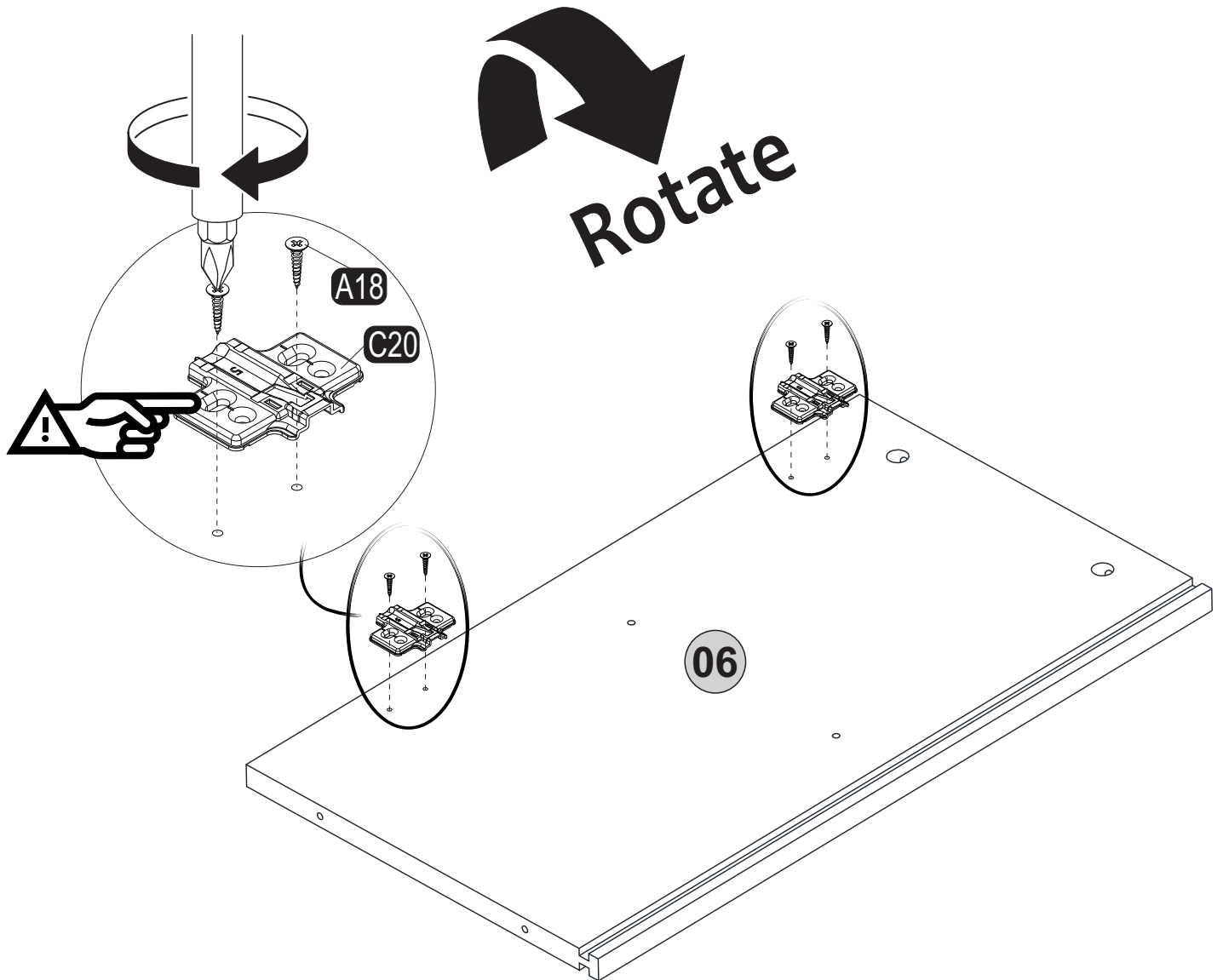
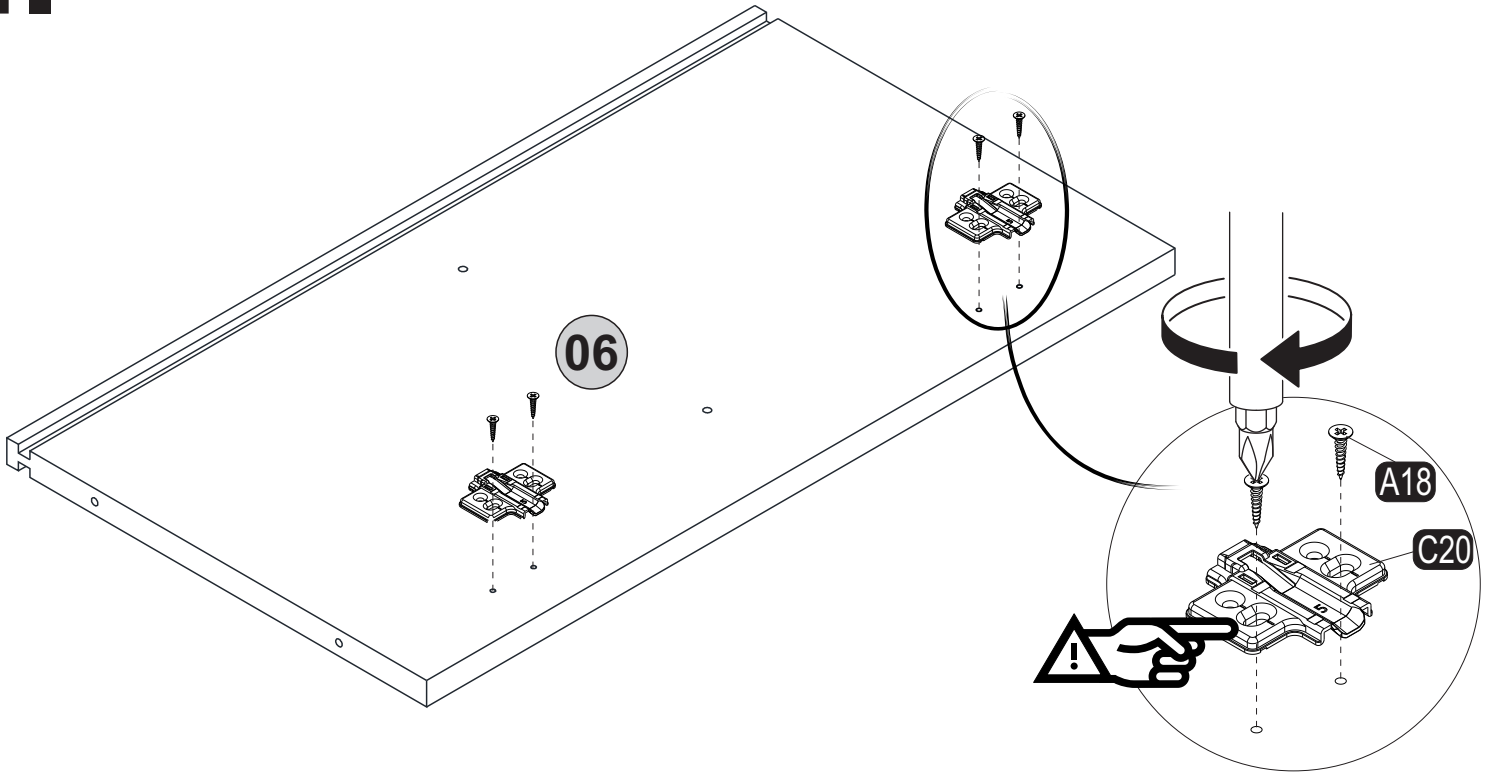

2_{step}

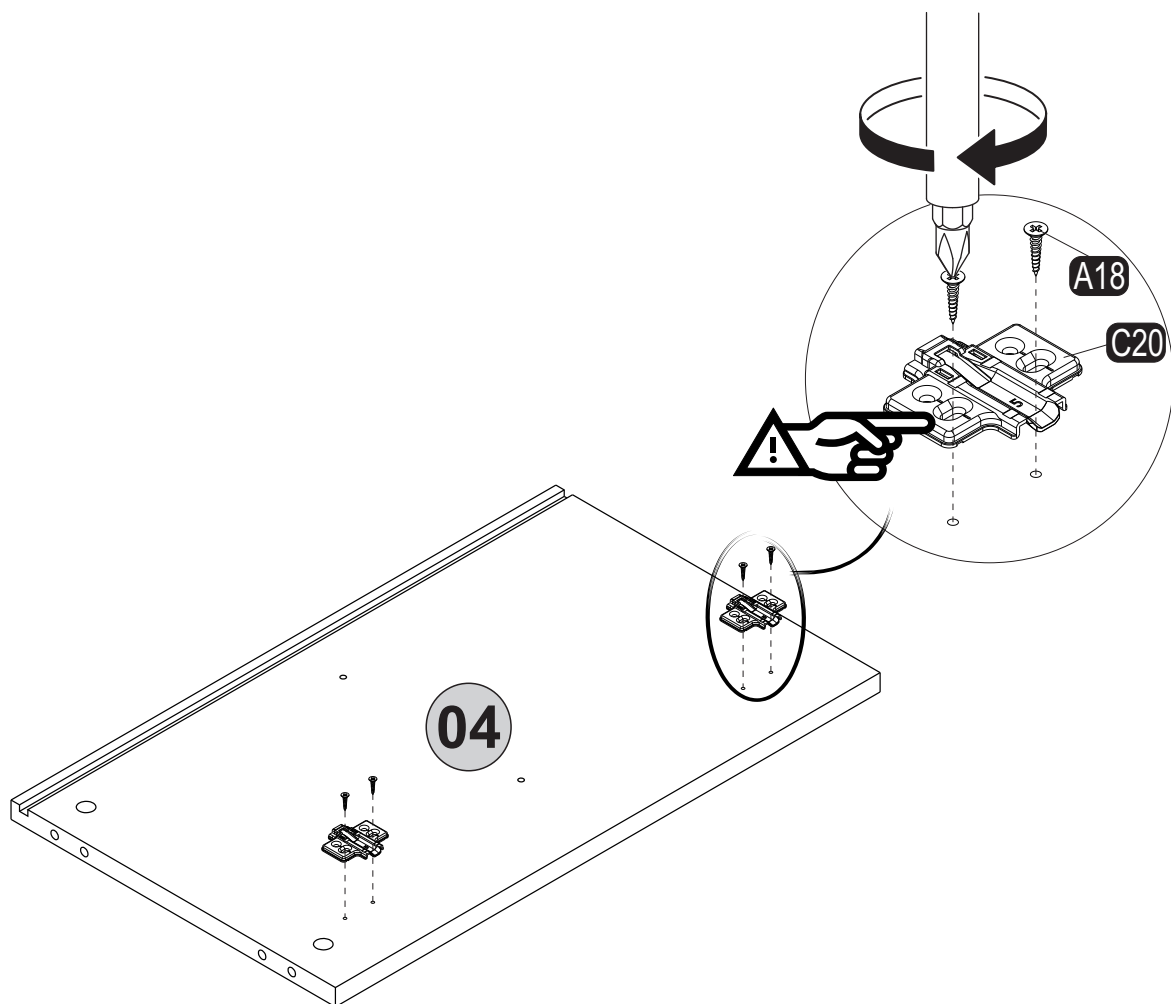

3_{step}

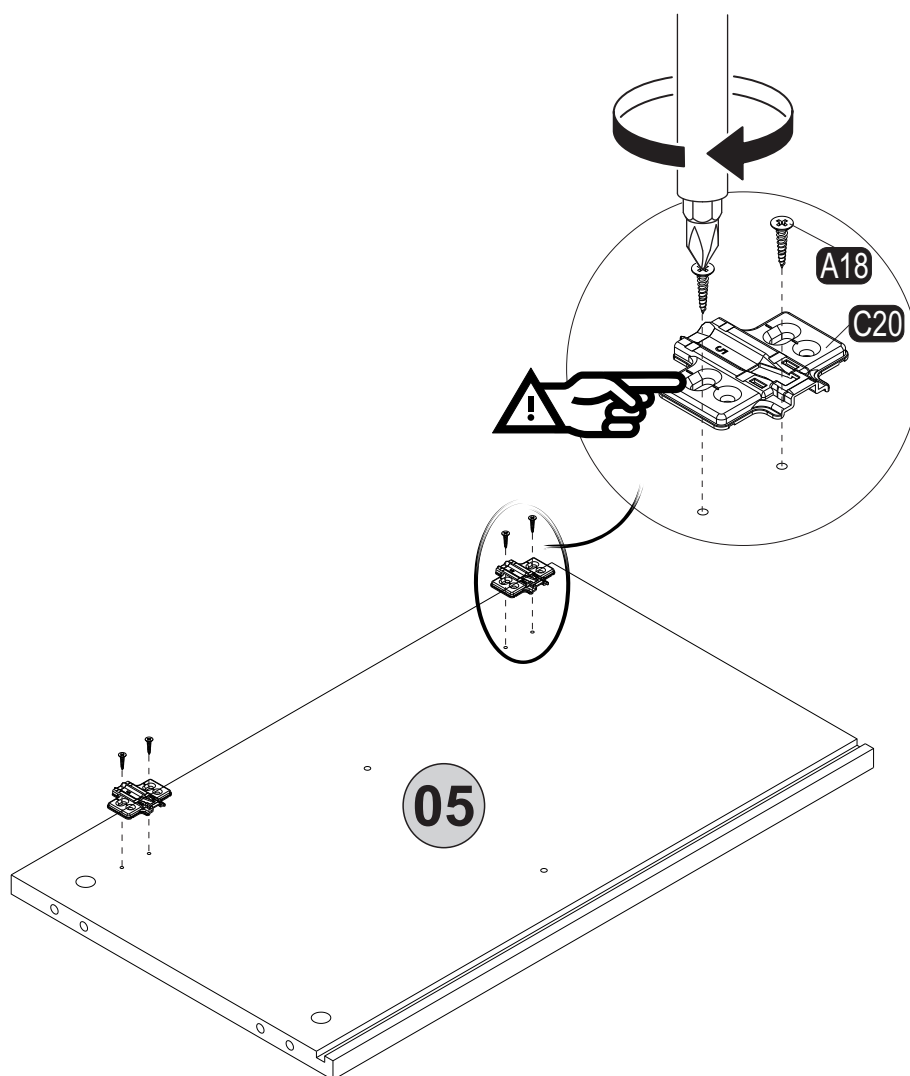

4._{step}

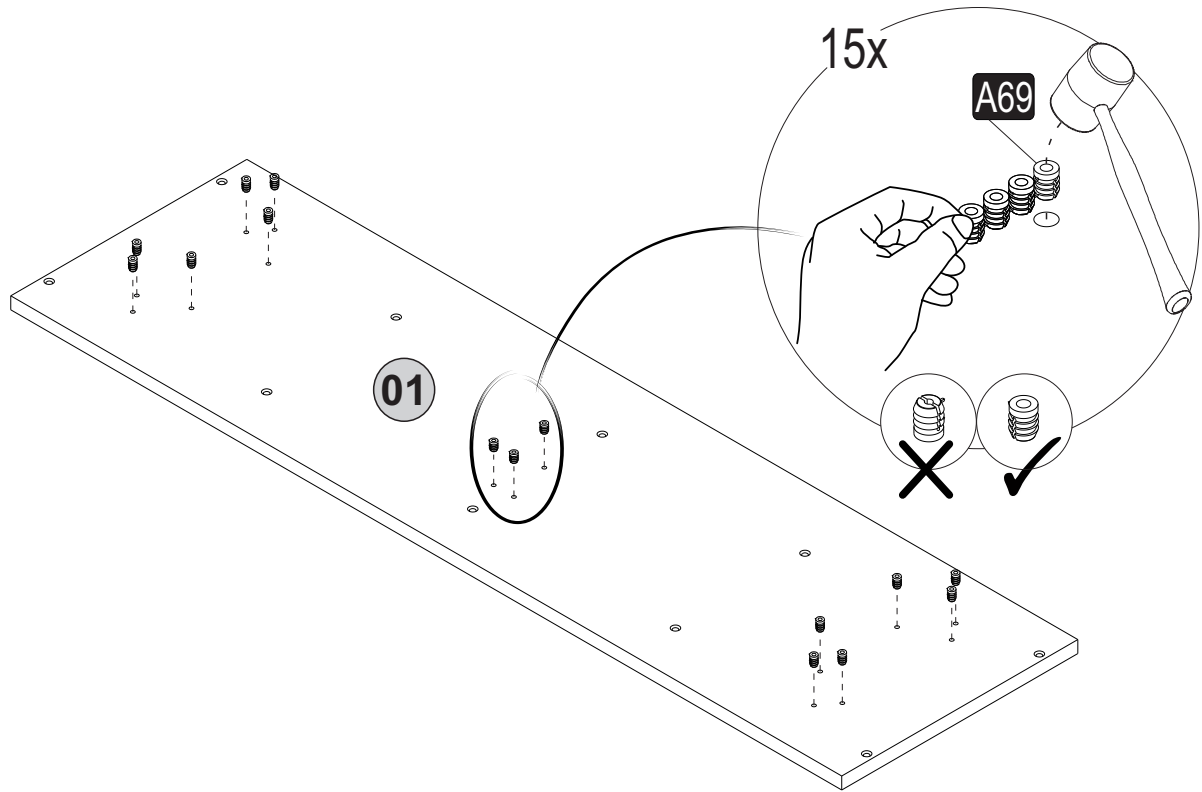

5._{step}

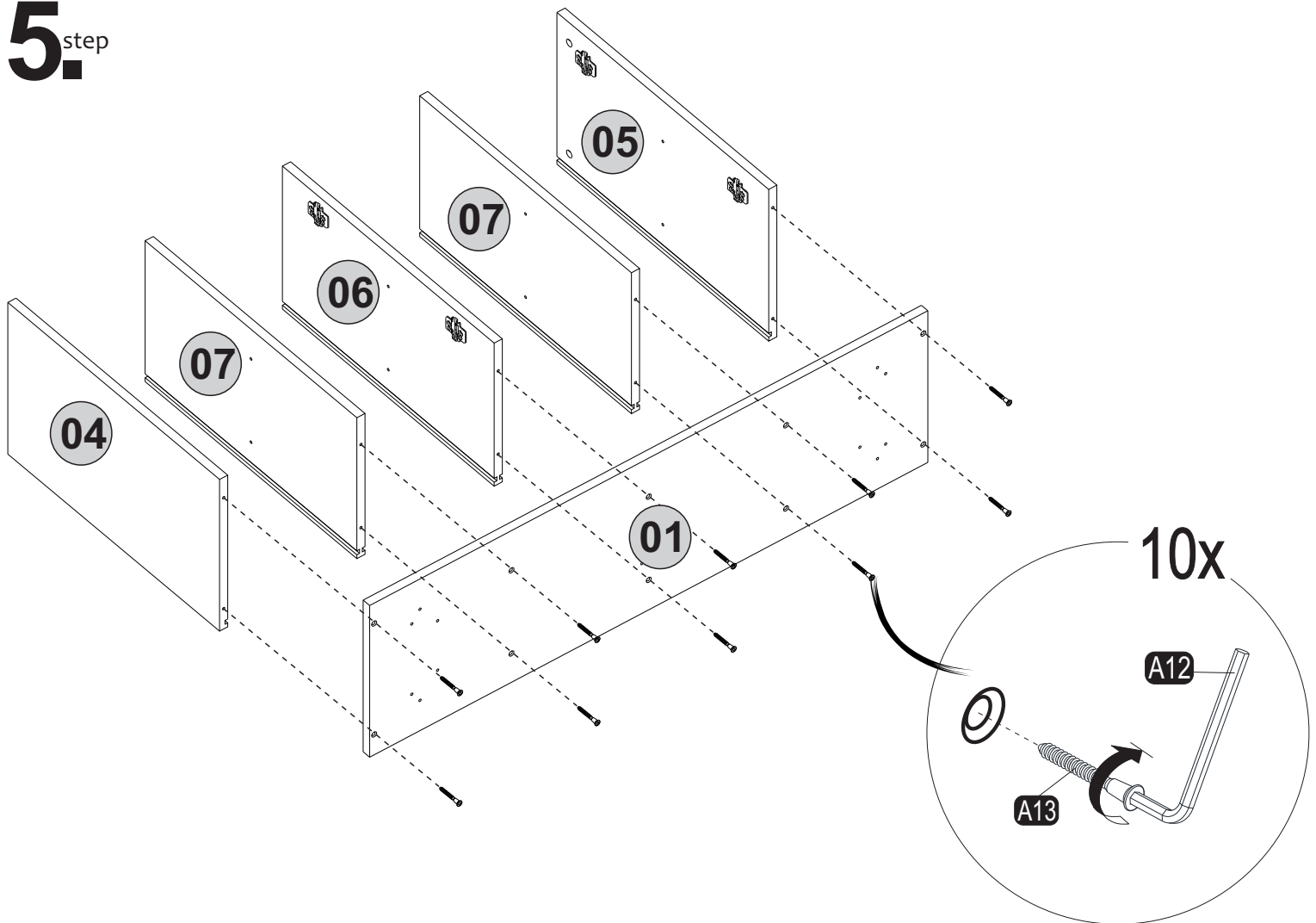

6^{step}

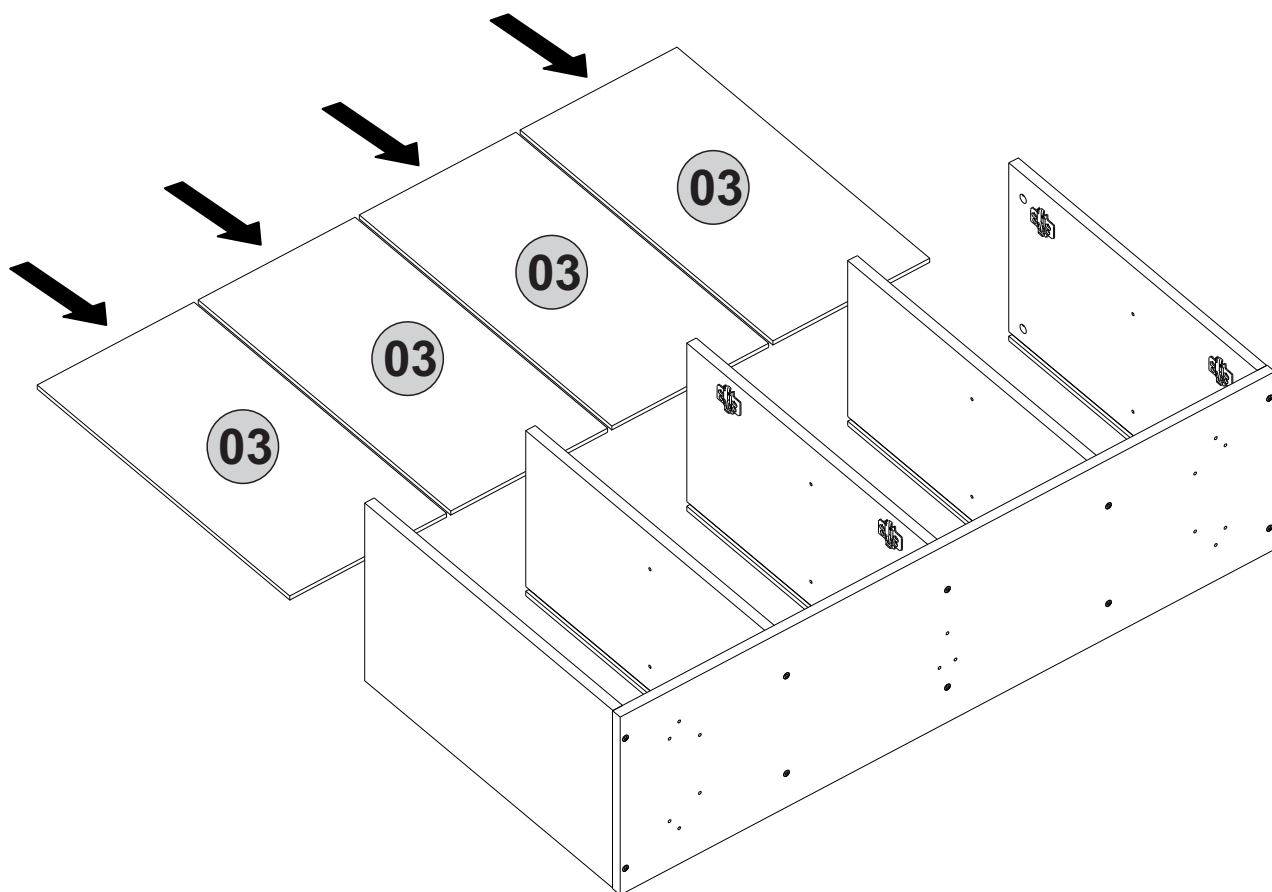

7^{step}

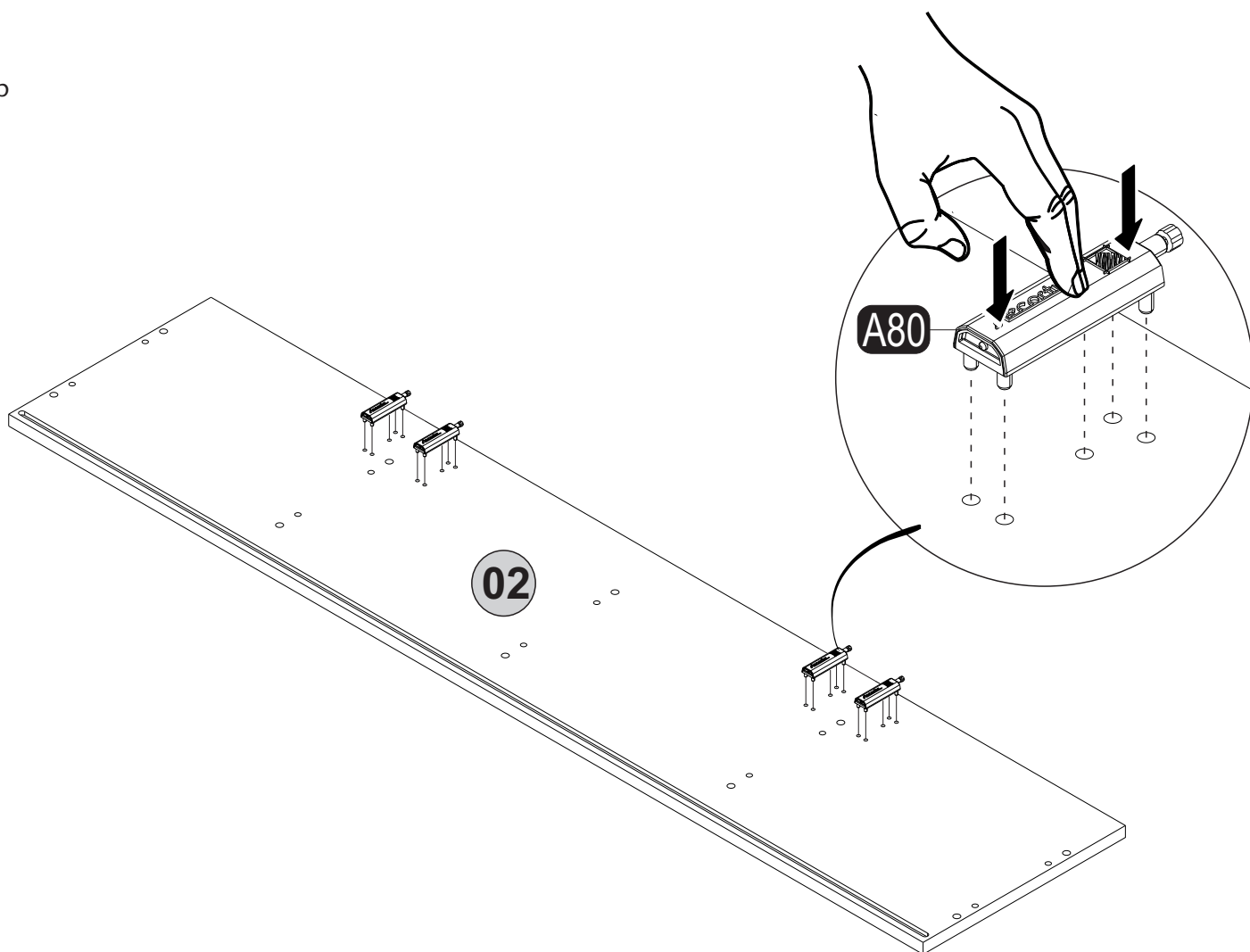

8_{step}

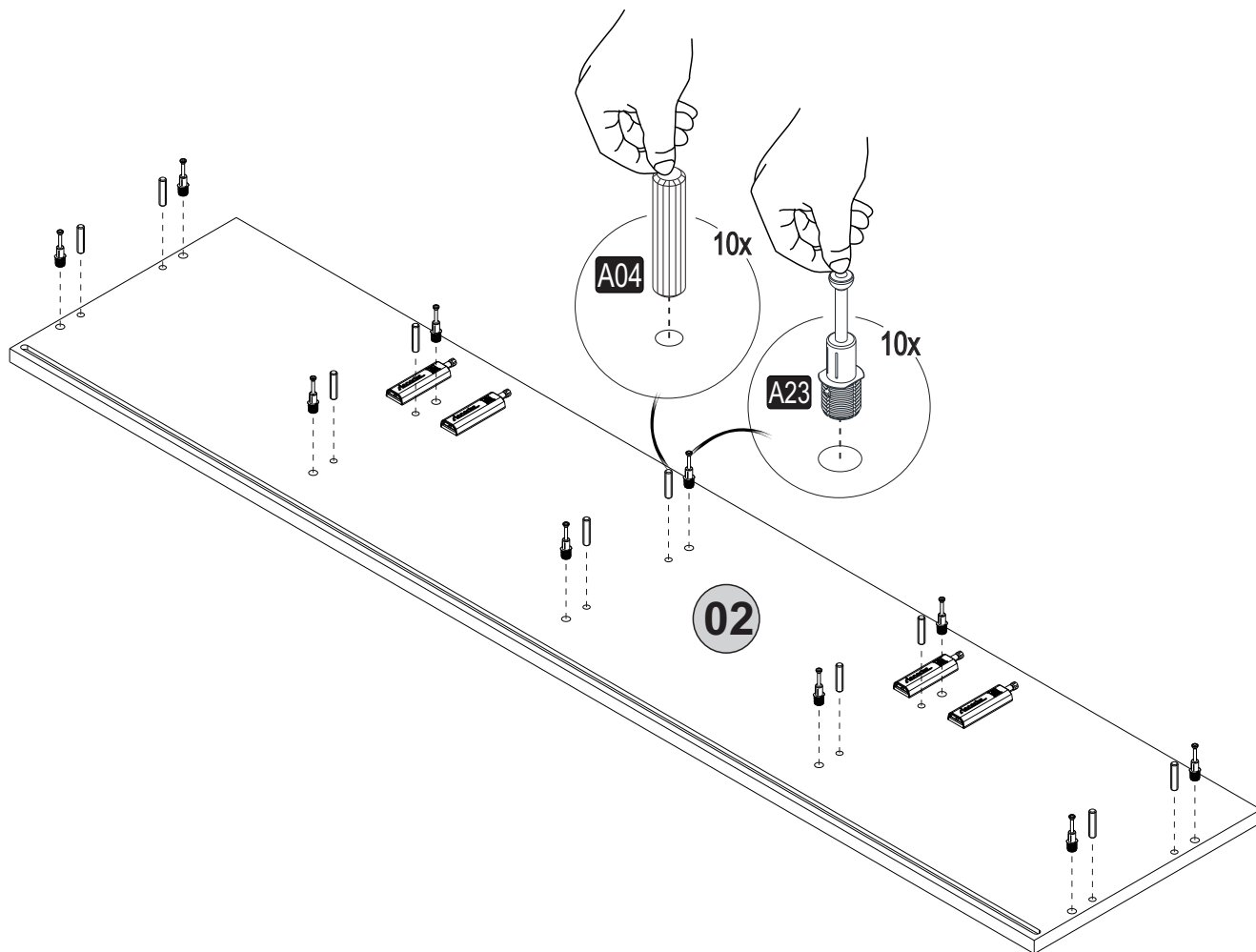

9_{step}

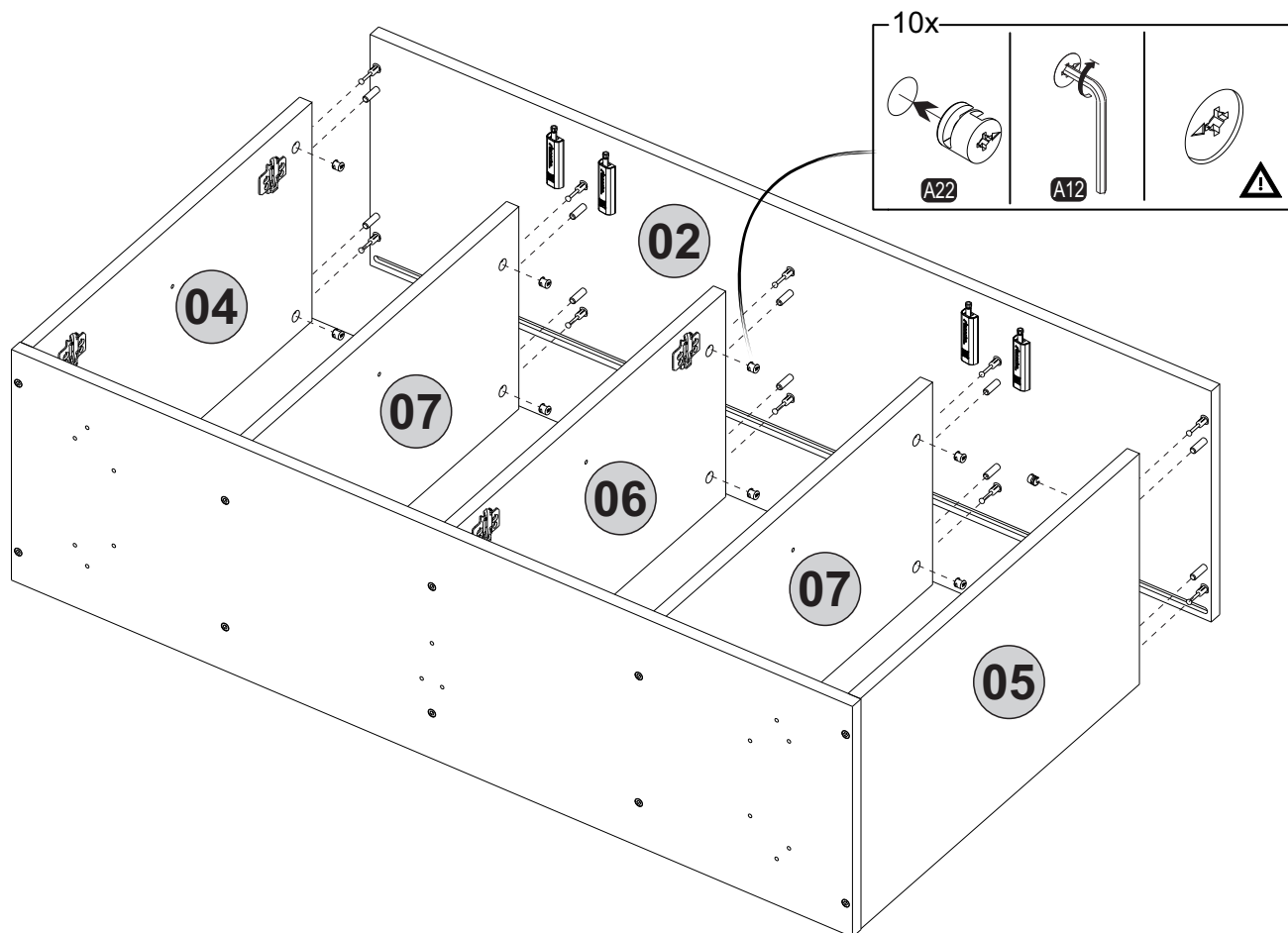

10. step

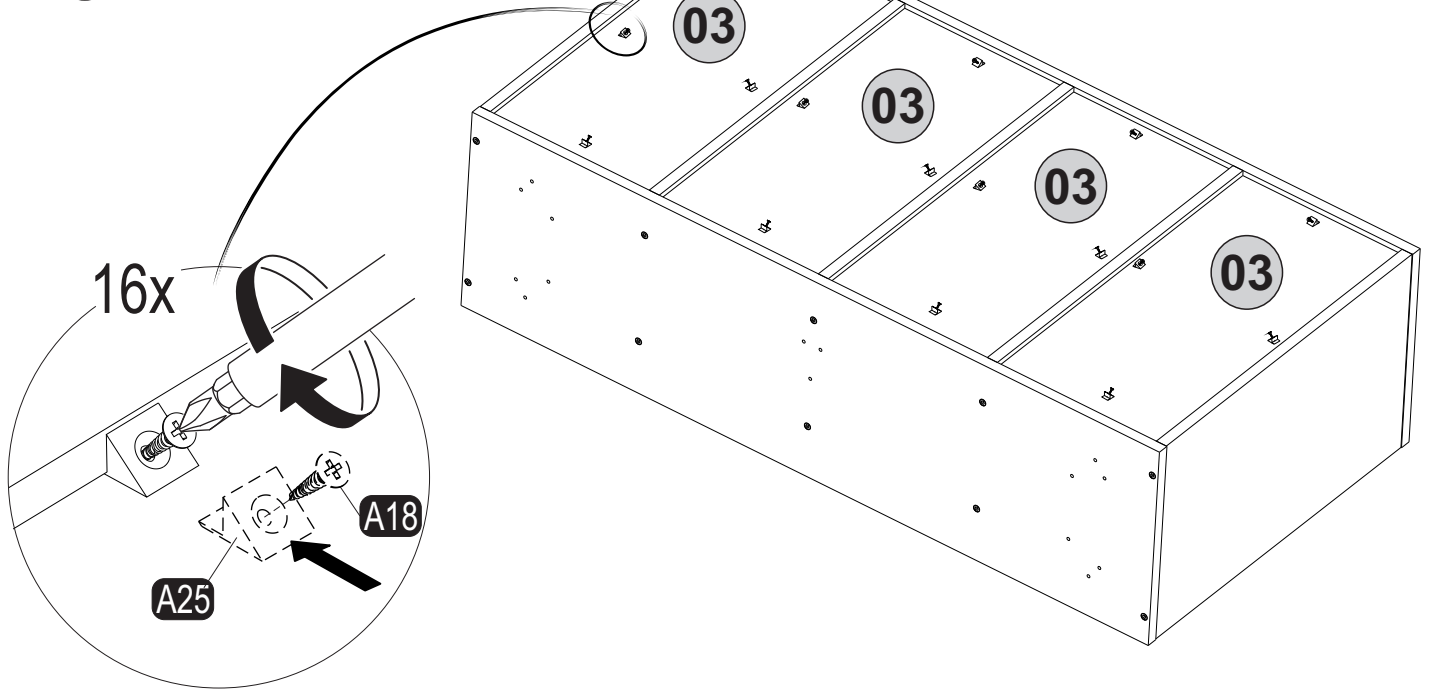

11. step

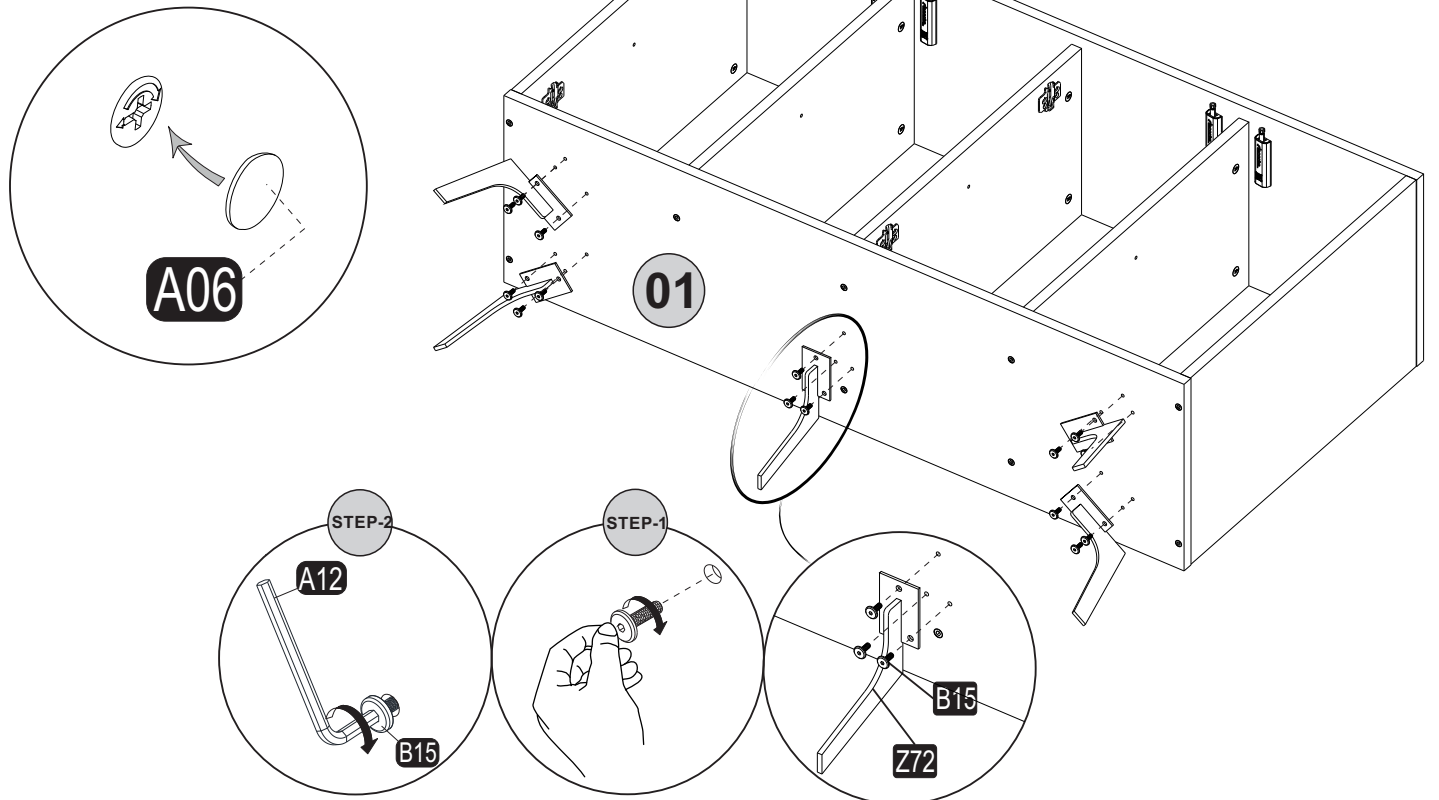

12.^{step}

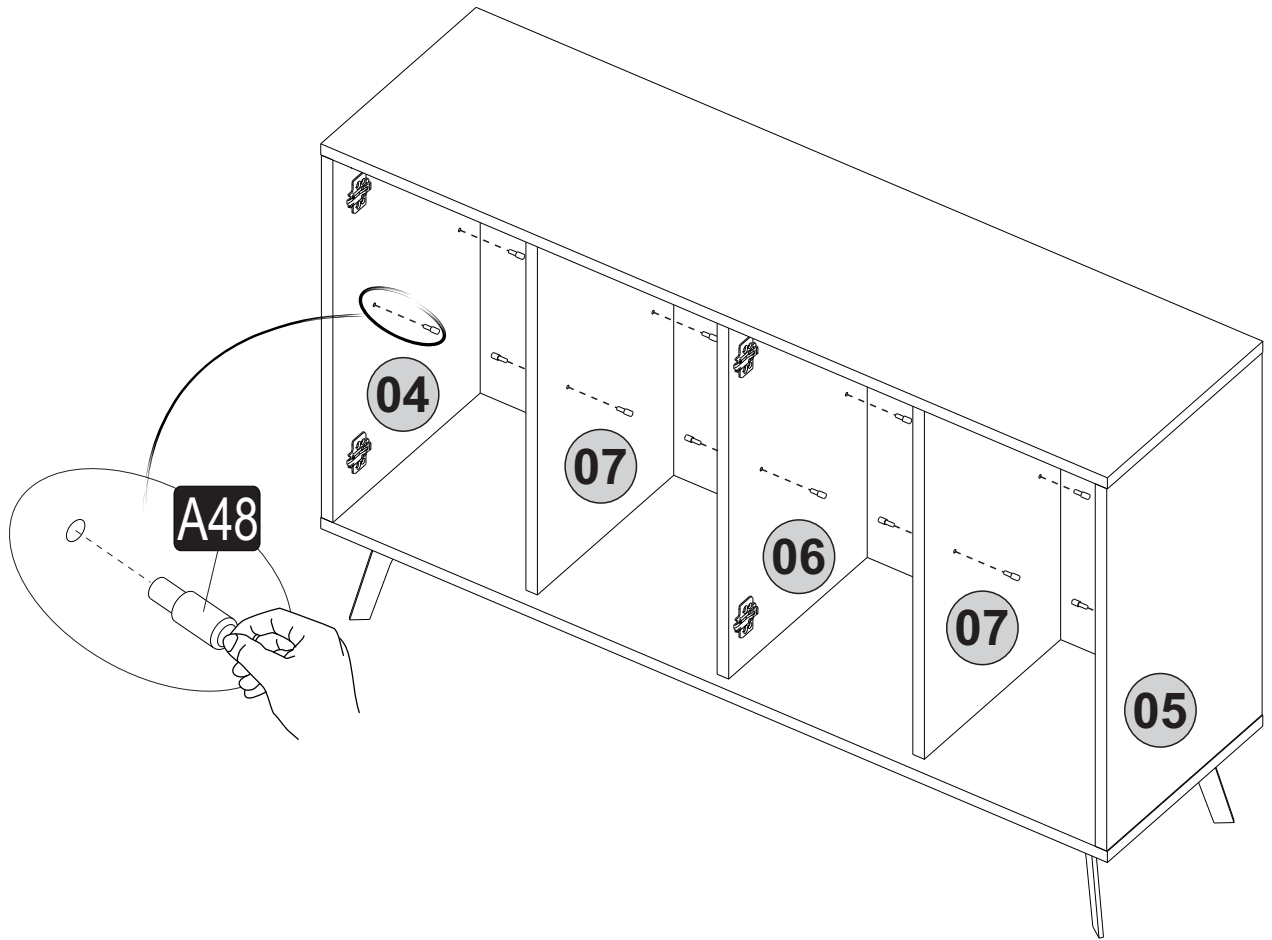

13.^{step}

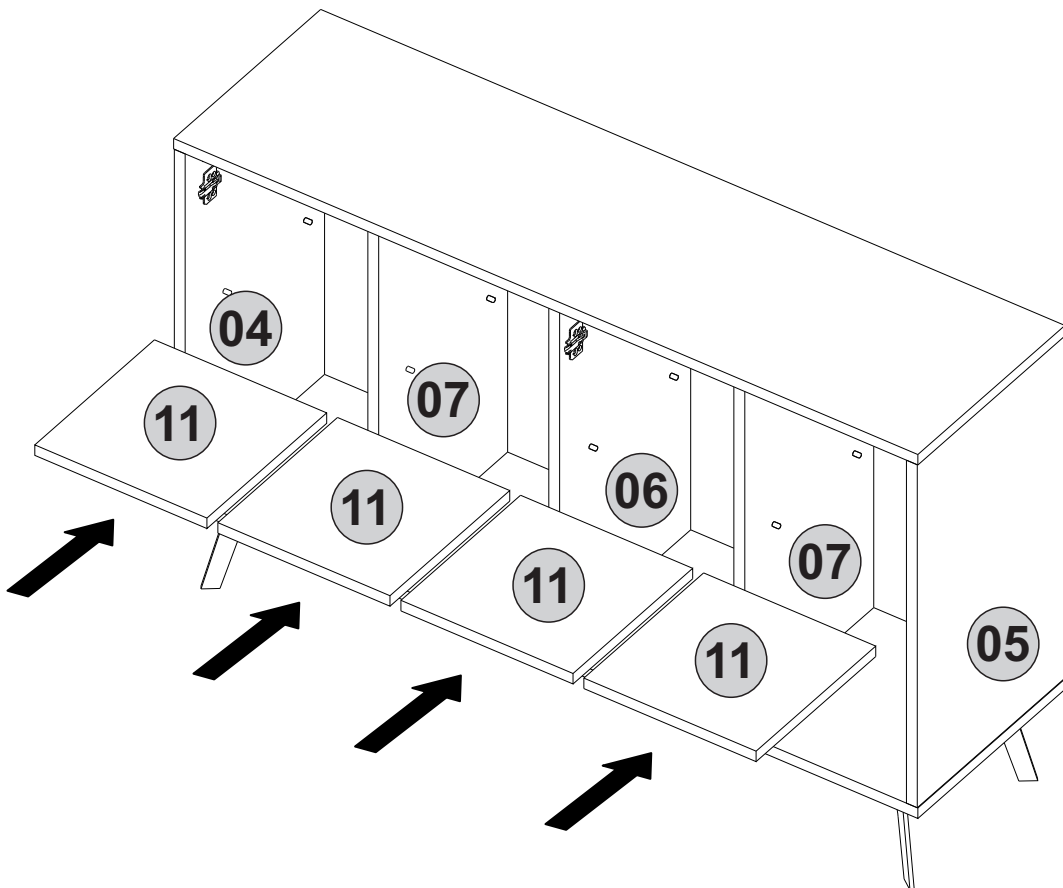

14.^{step}

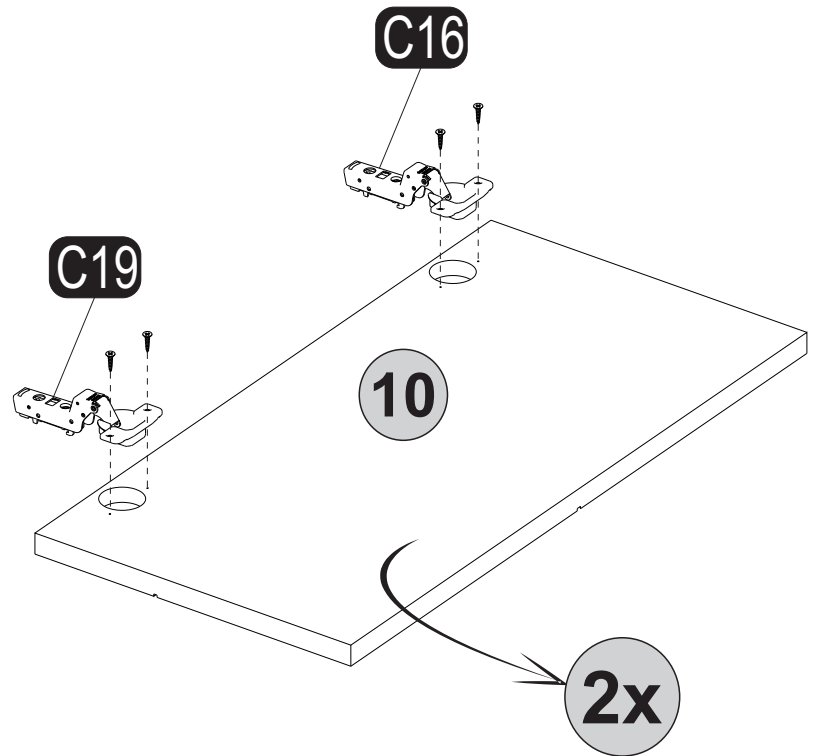
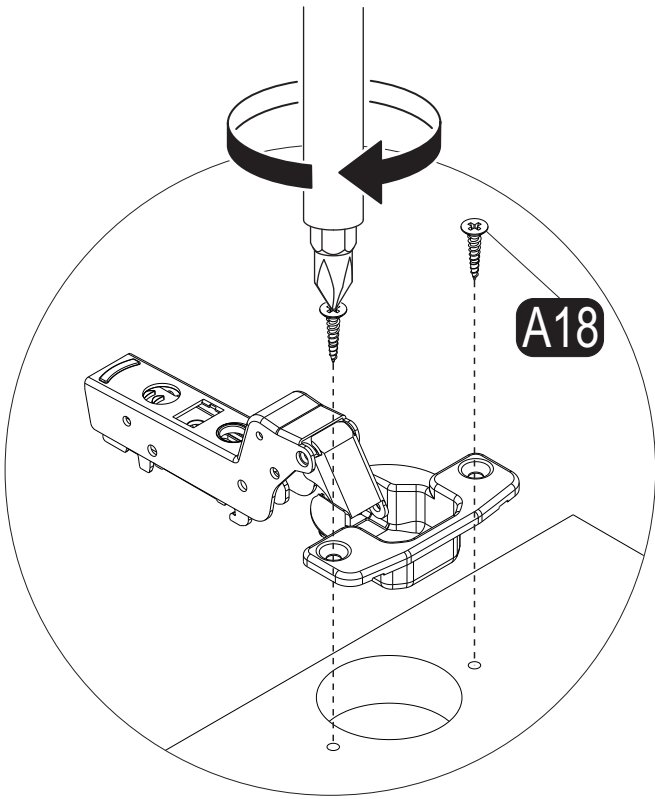
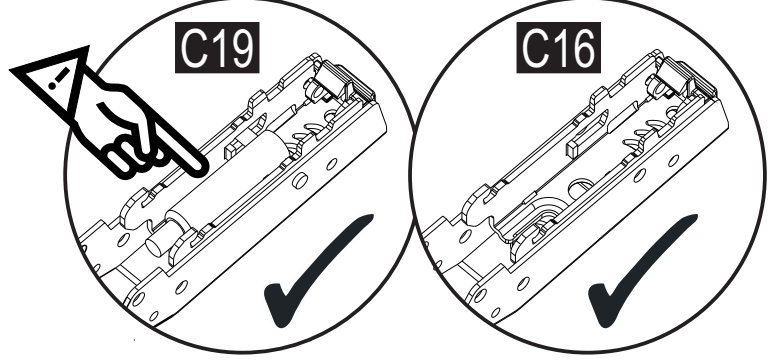
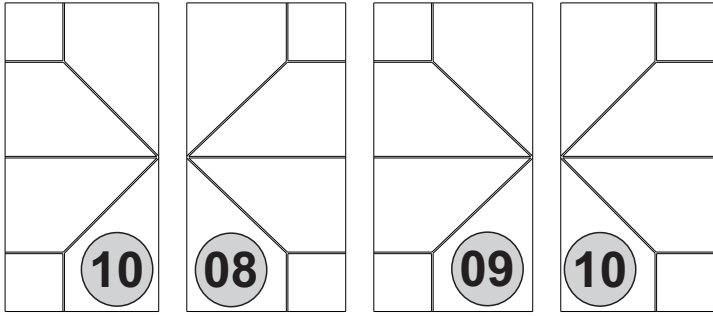
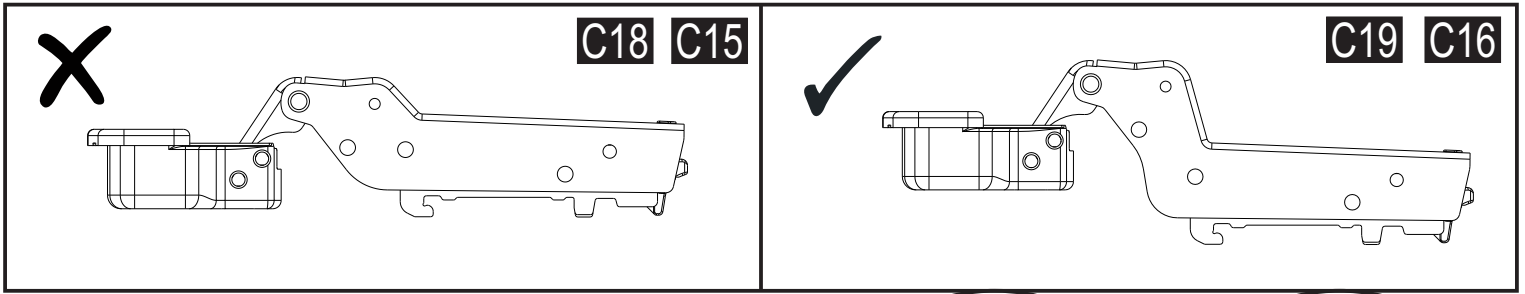

15. step

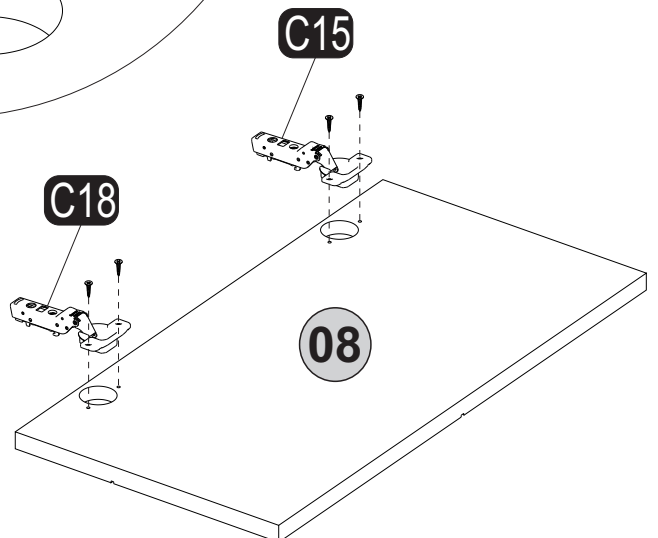
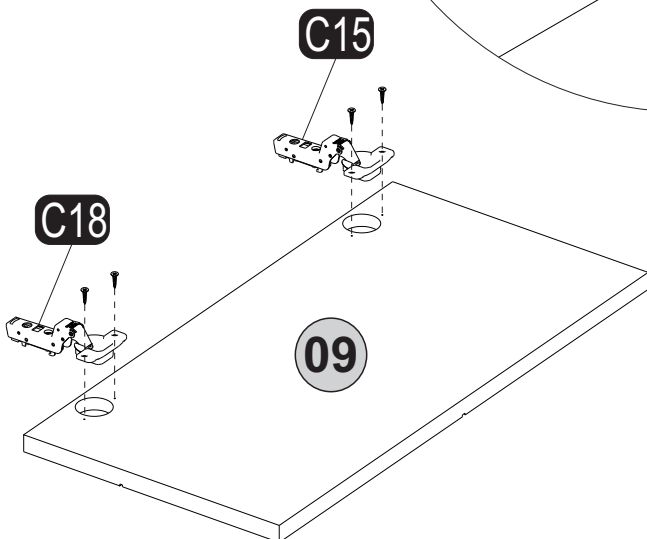
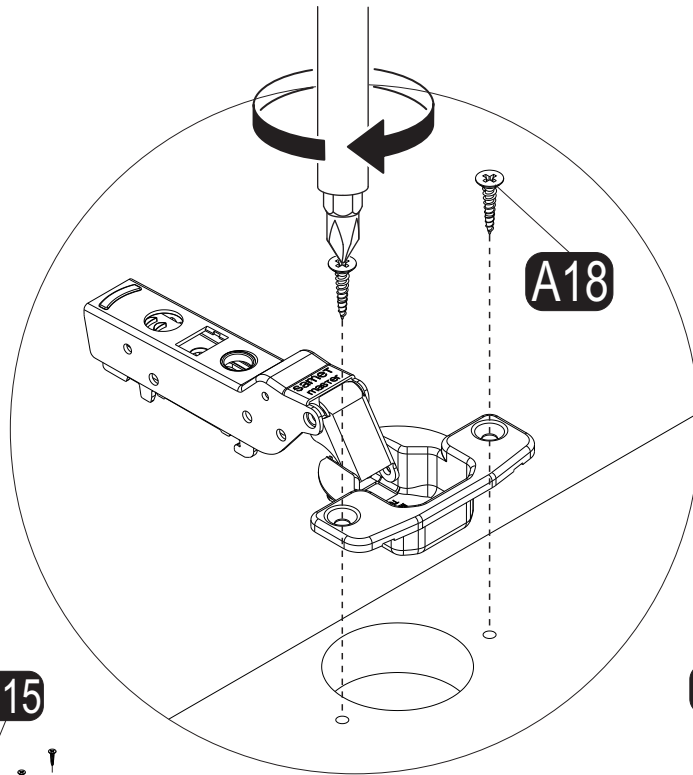
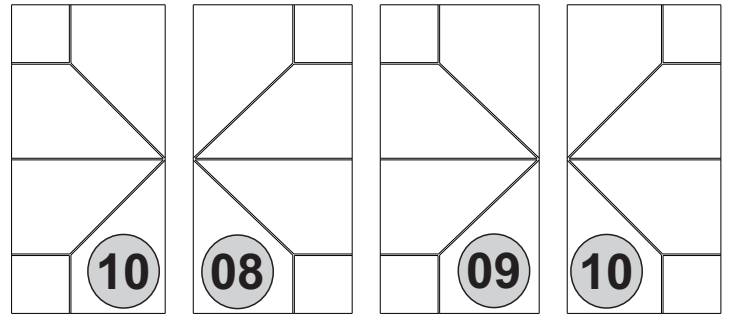
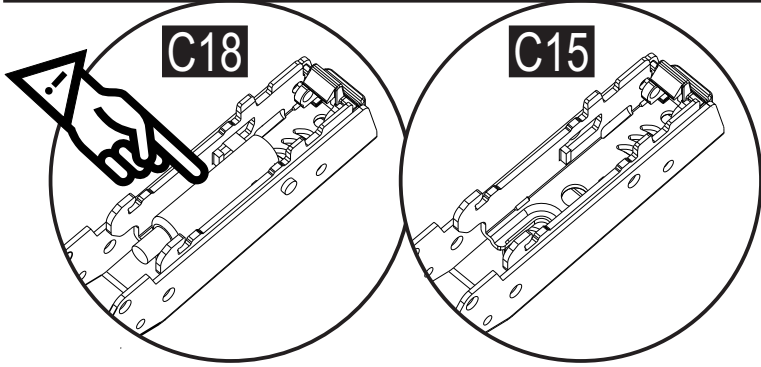
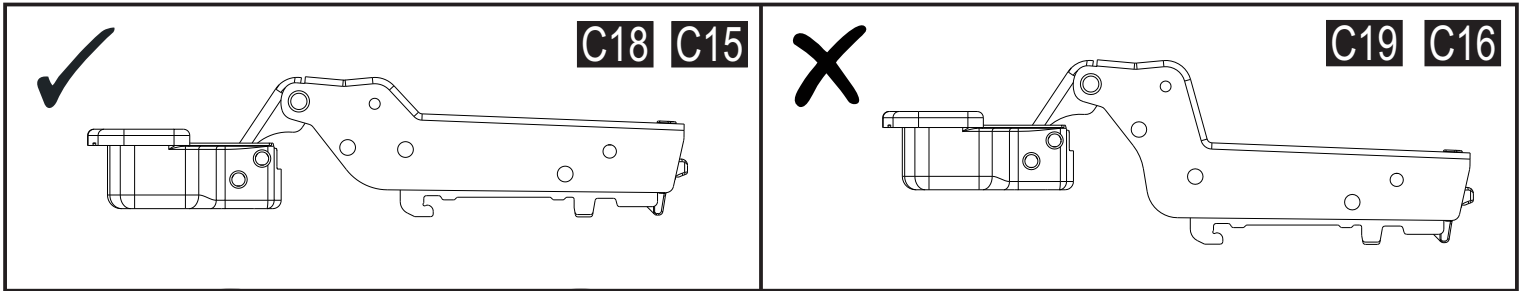

16.^{step}

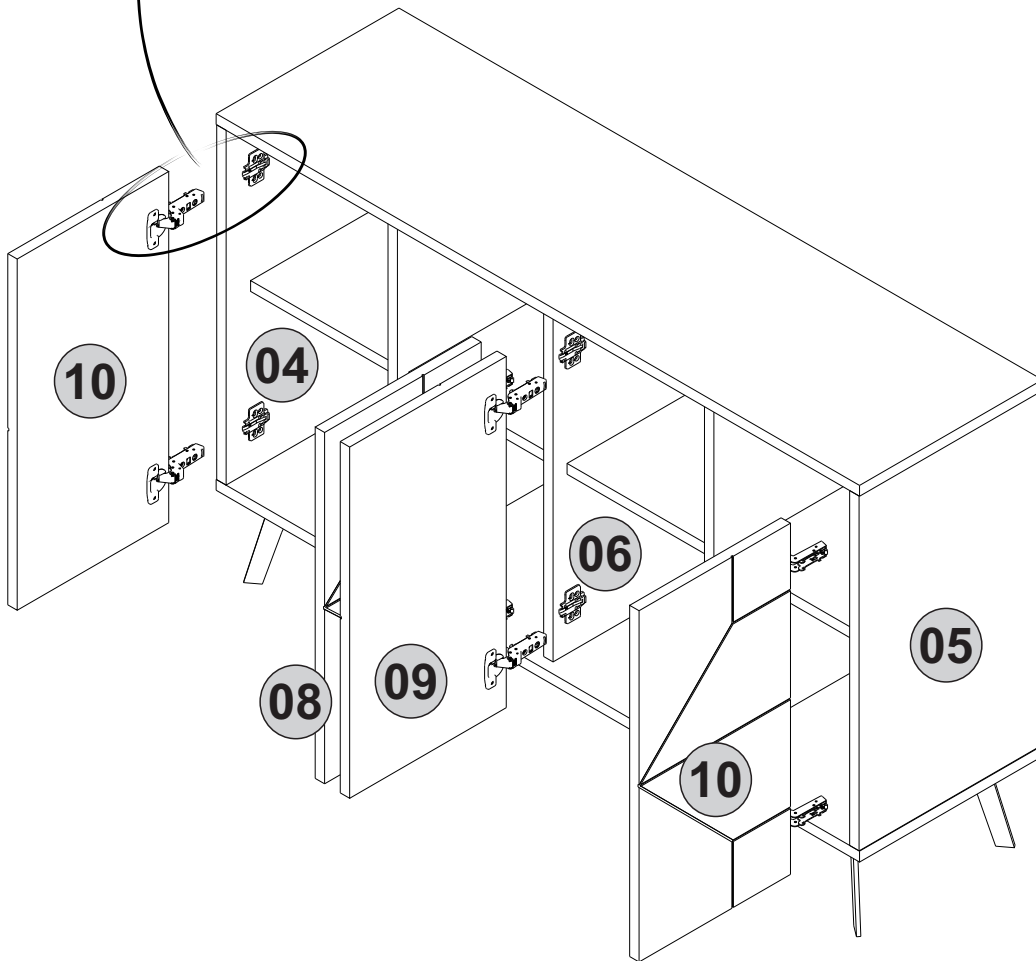
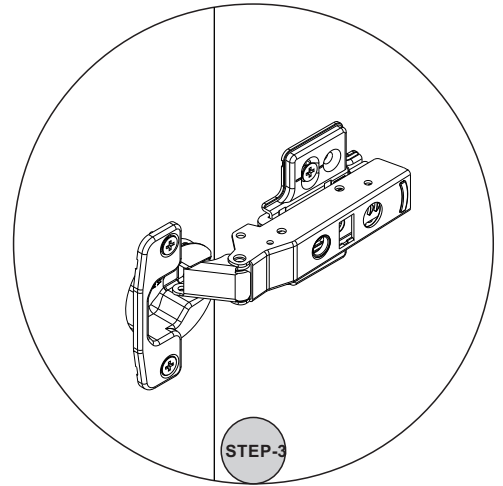
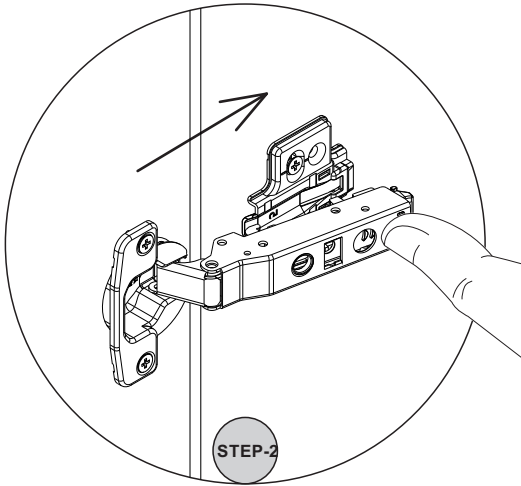
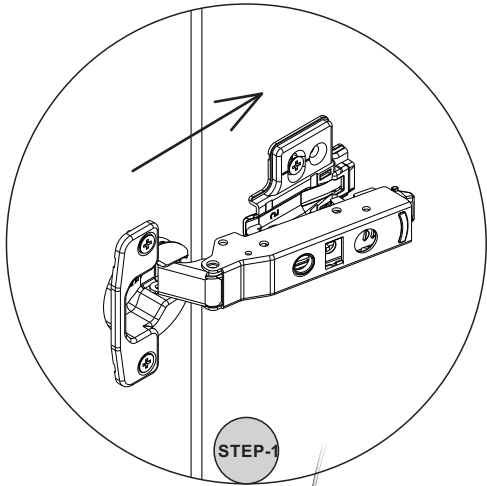

17. step

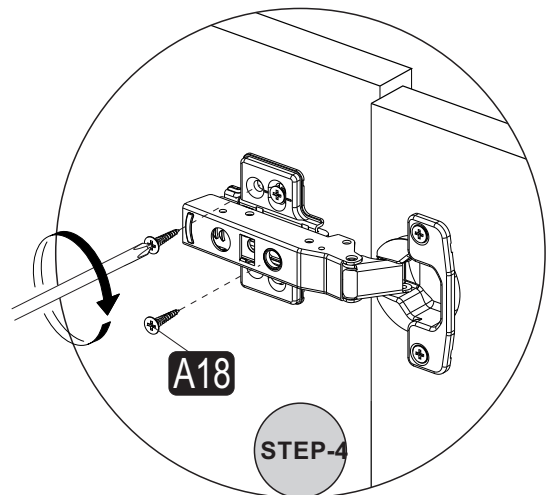
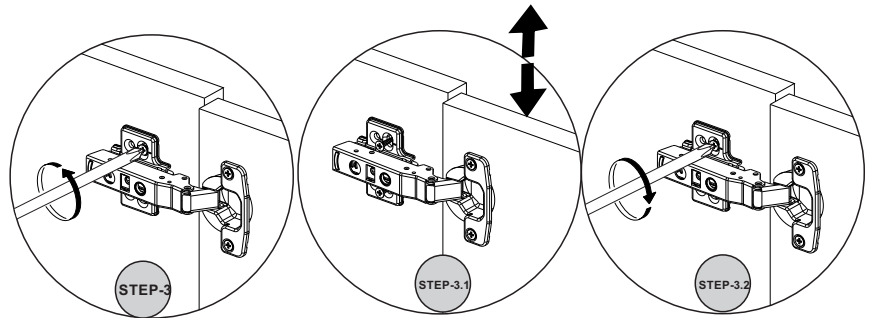
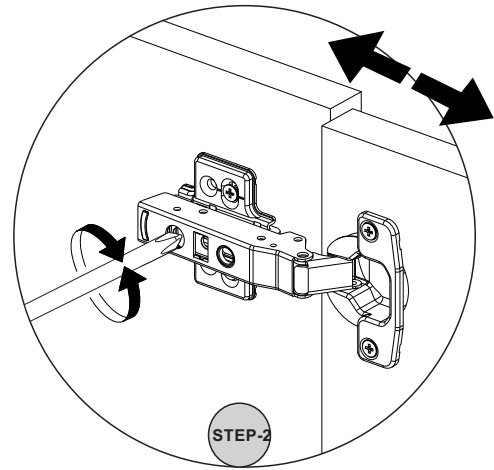
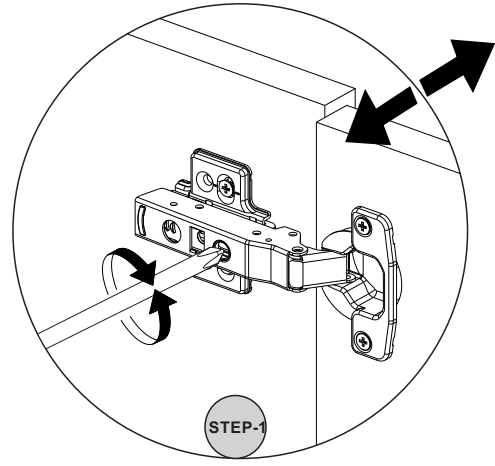
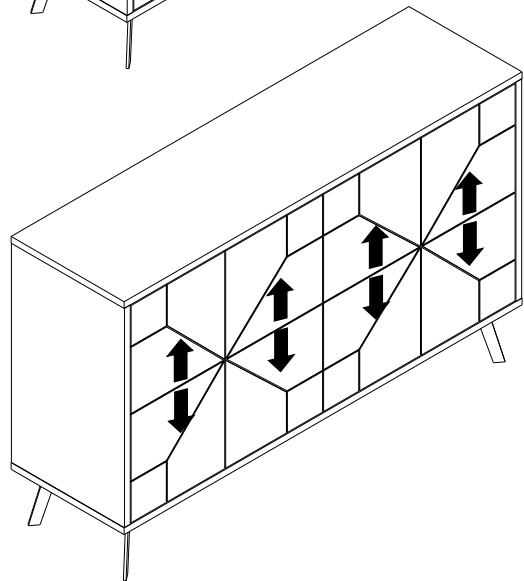
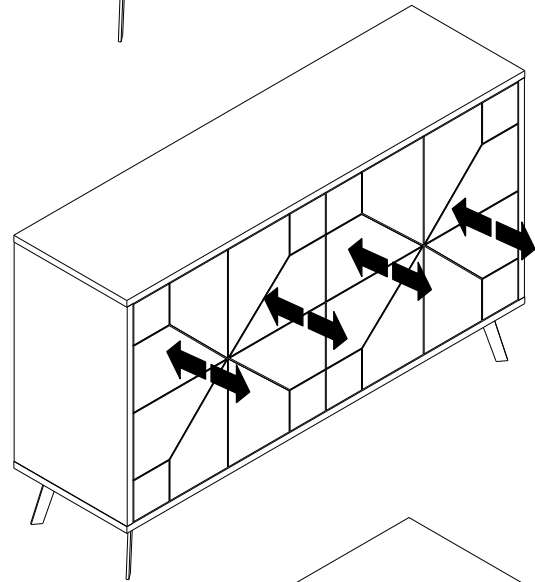
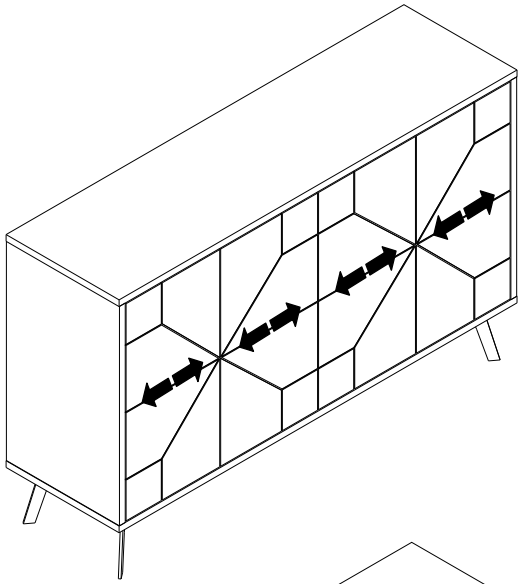

18. step

