

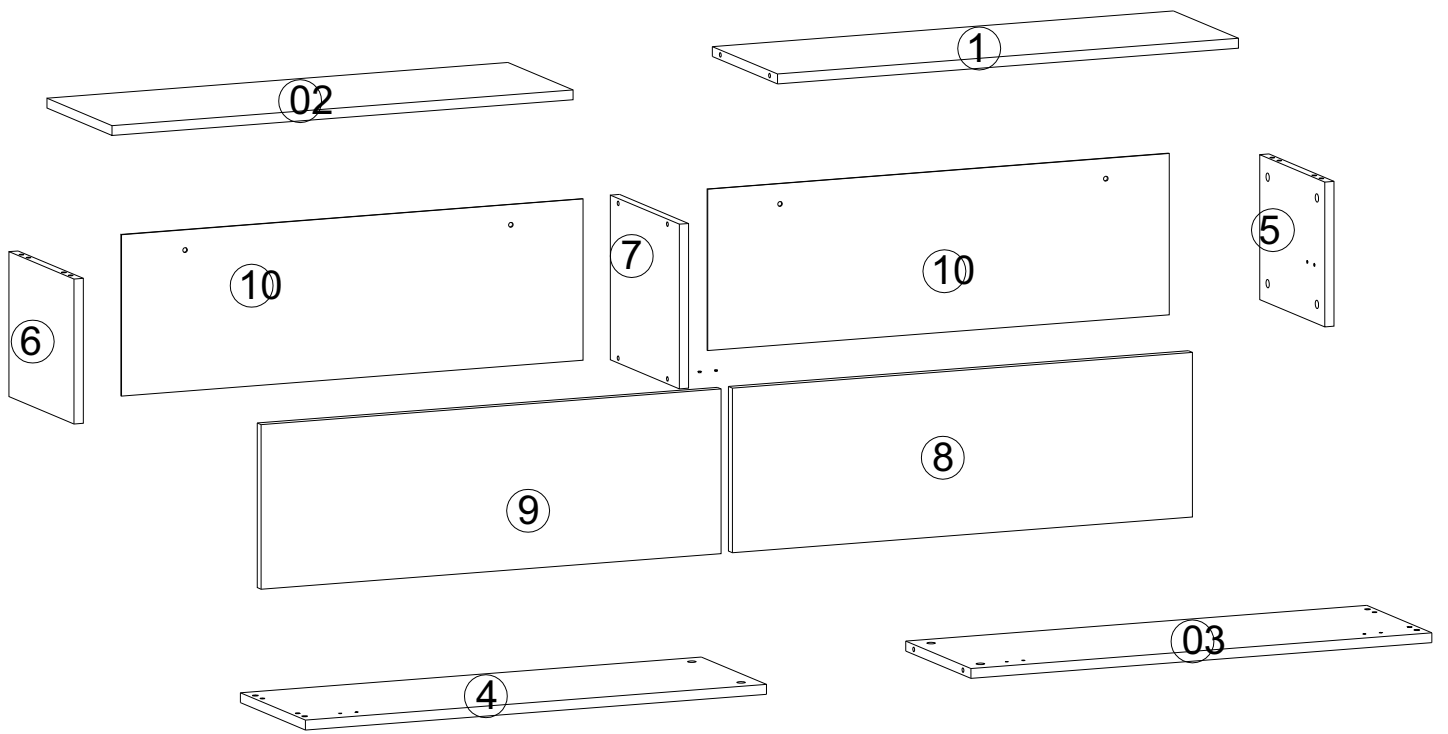









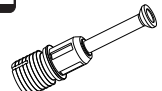

GP042-0328,3

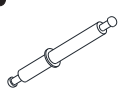
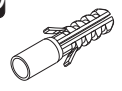

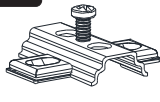
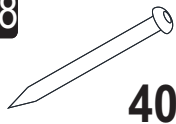
241,8 x 31,7 x 30cm

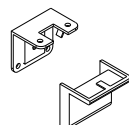

A01  16x	A02  8x	A03  8x	A06 UM(Sgml)  4x	D69 Ø8  4x
A19  2x	H48 DM  4x	H49  4x	A28  40x	D41 5x70 YHB  4x
A10 3,5x18 YHB  32x	A41  4x	A04  A16x	0x	0x

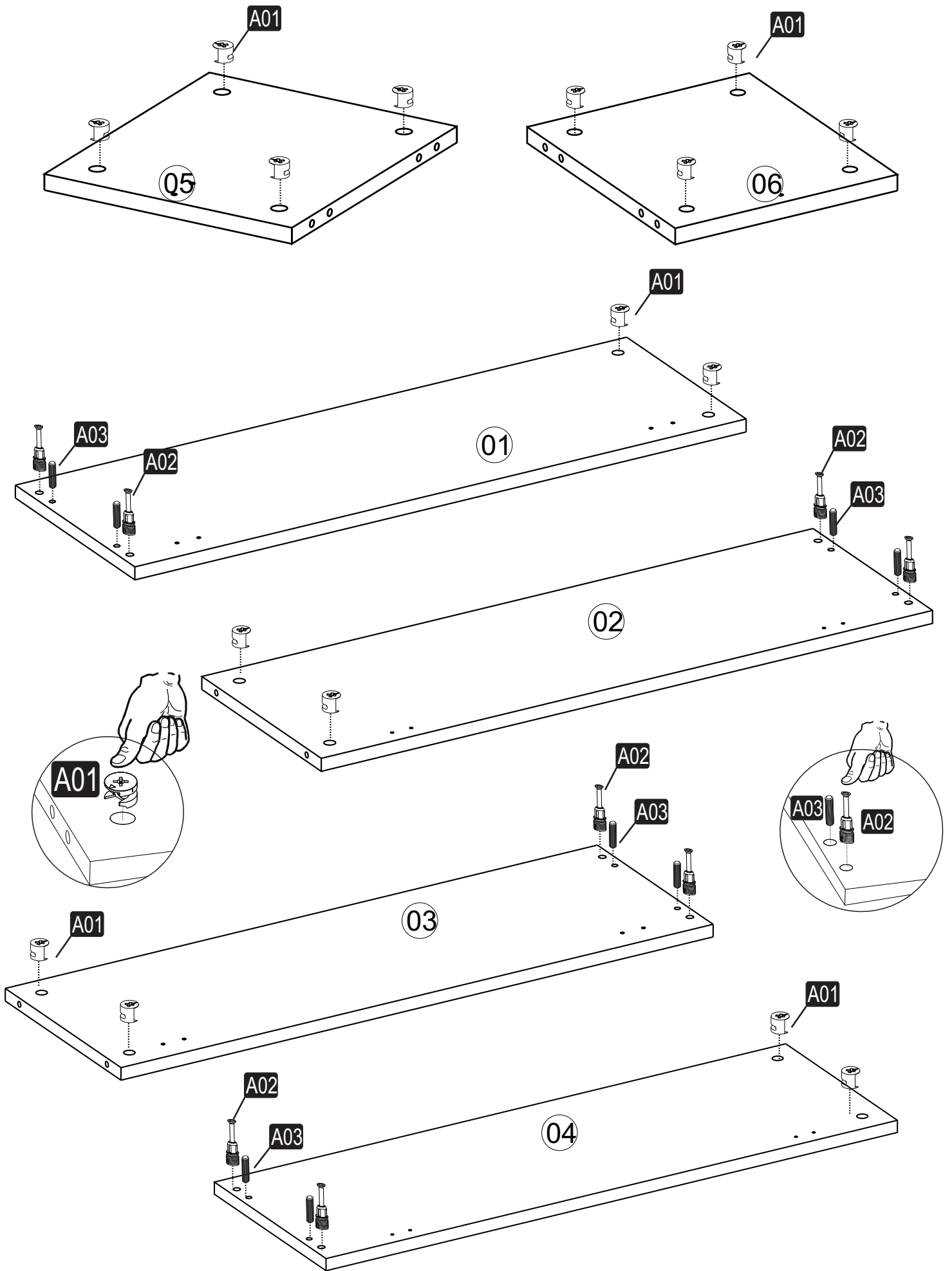

1

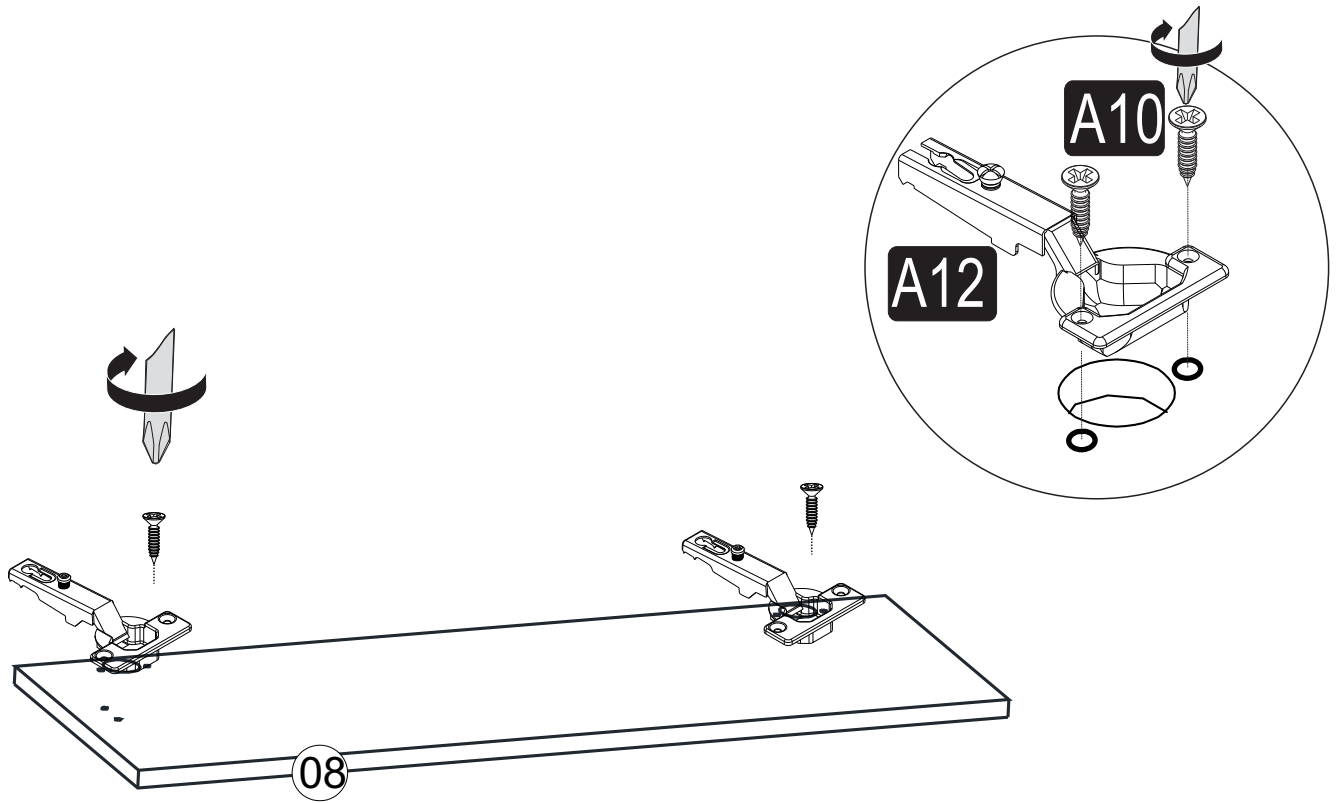

2

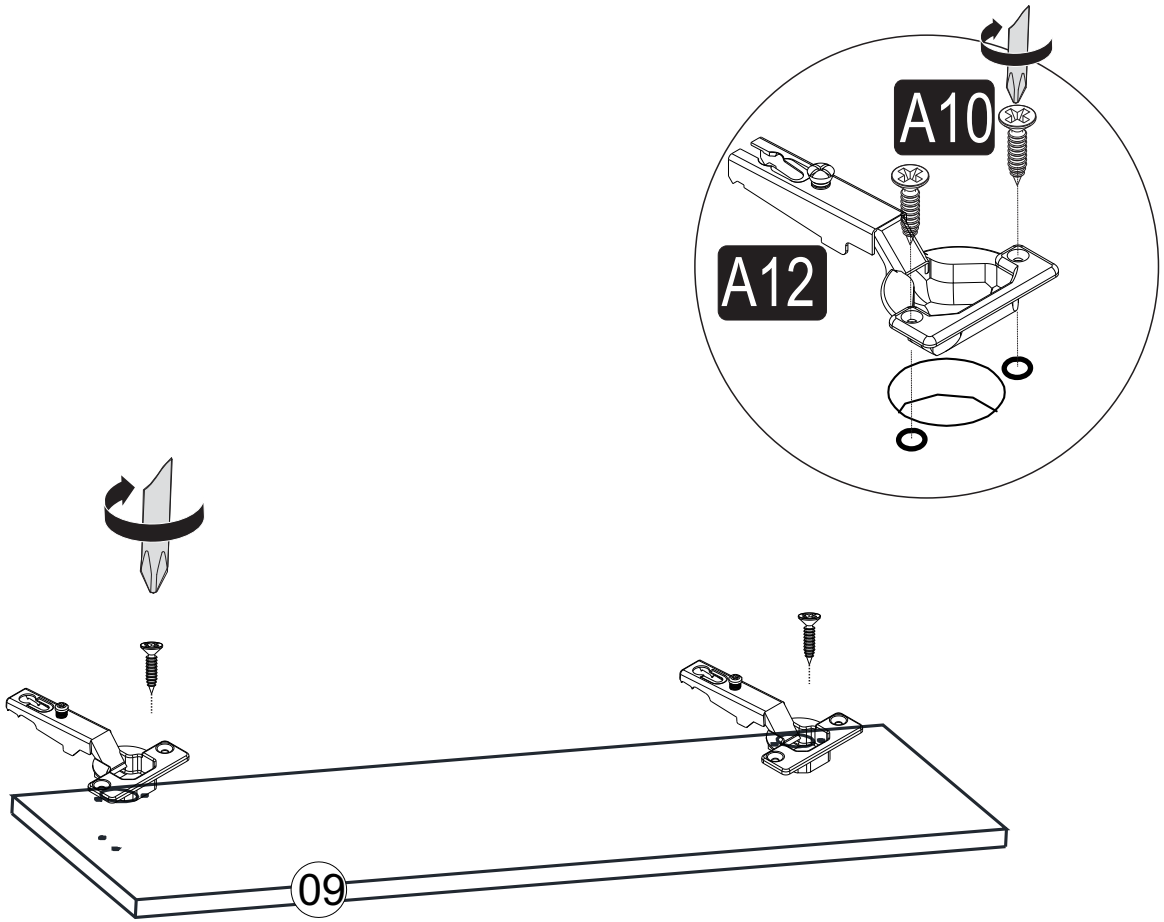

3

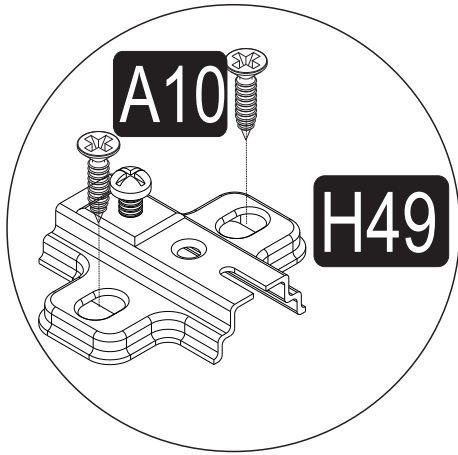
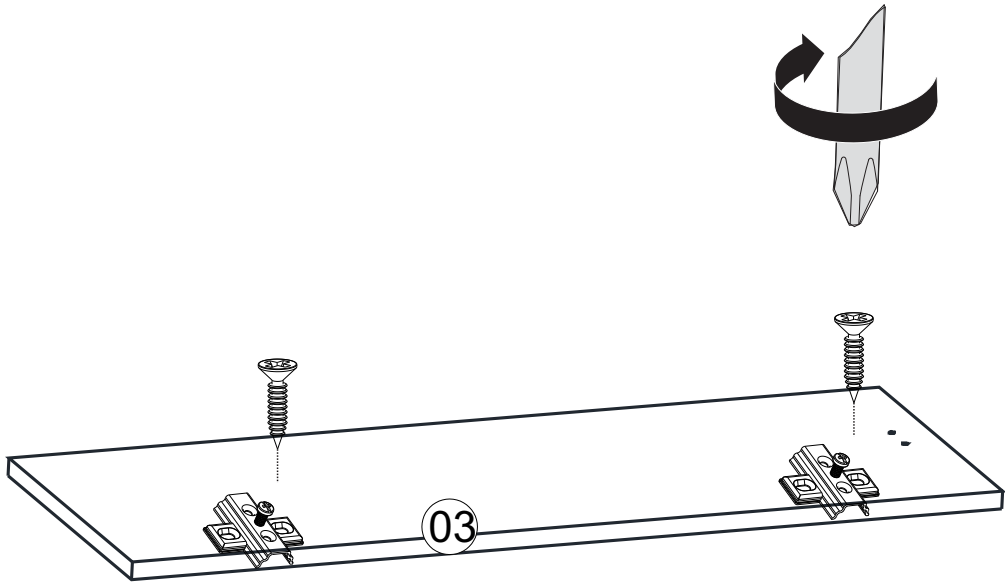

4

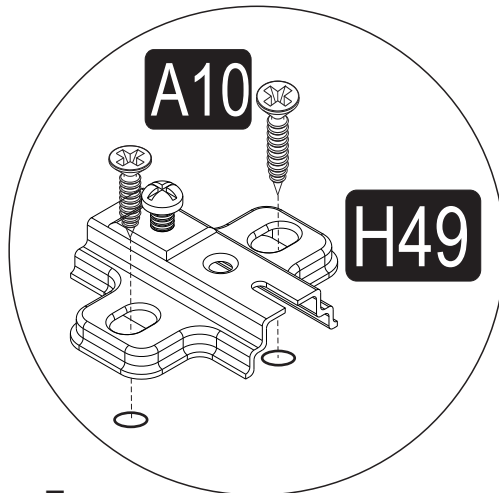
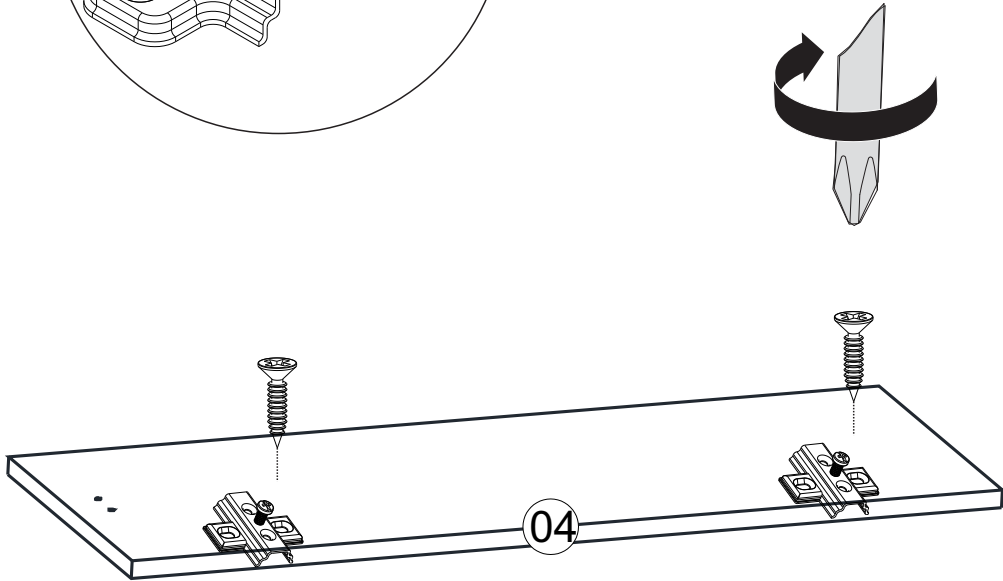

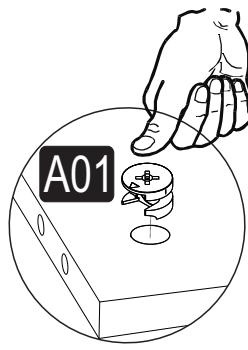
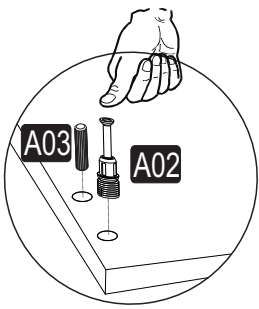

5

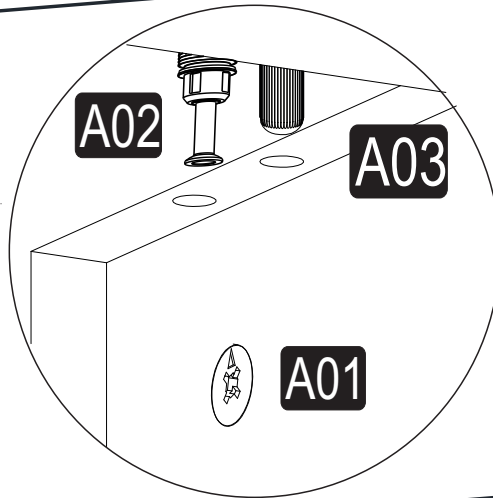
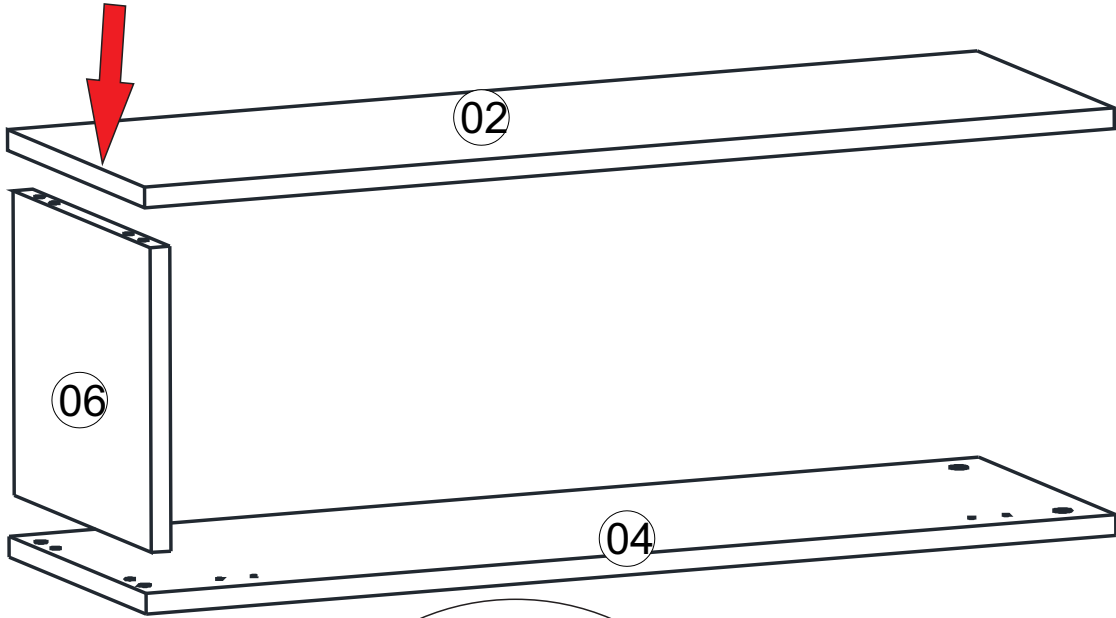

6

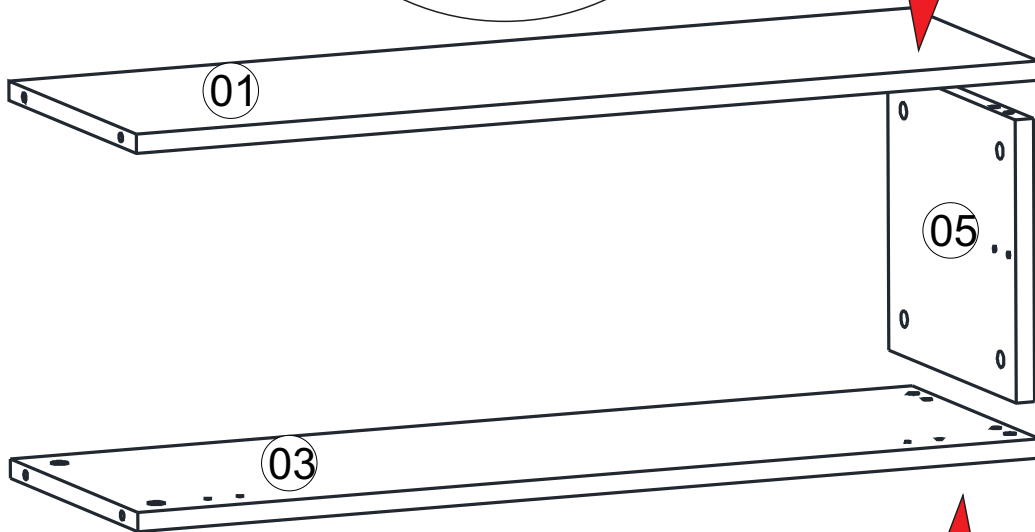

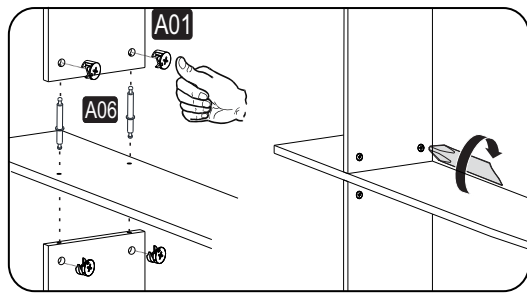

7

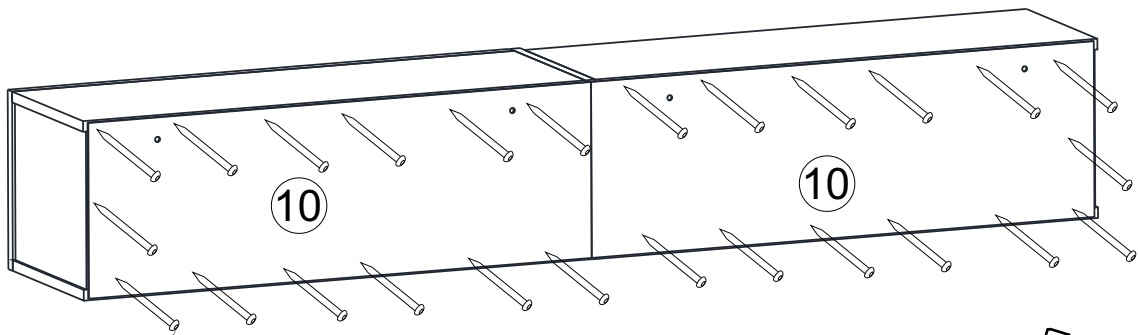
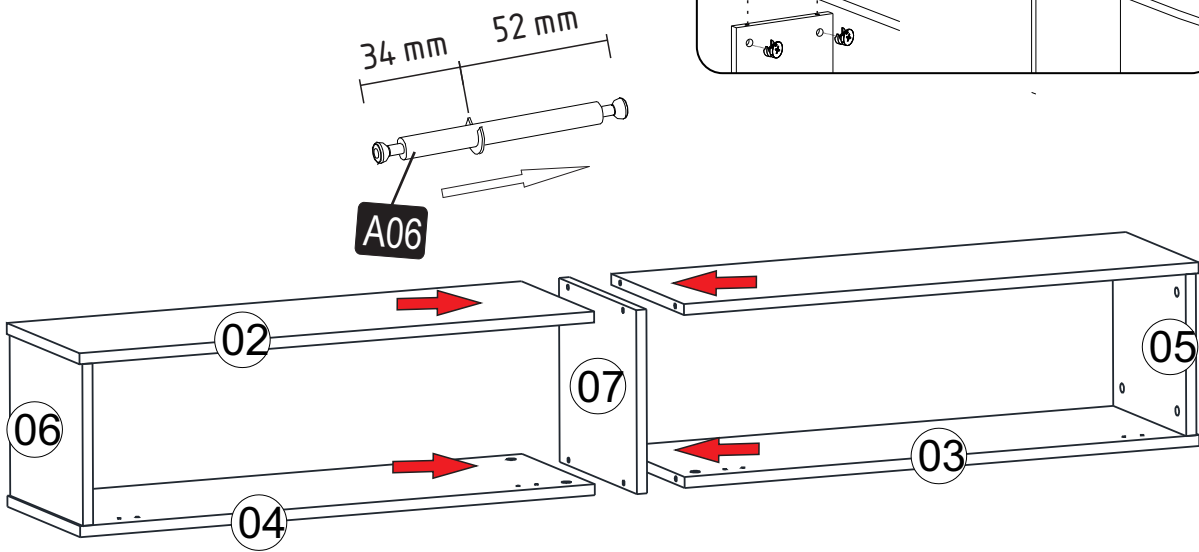

8

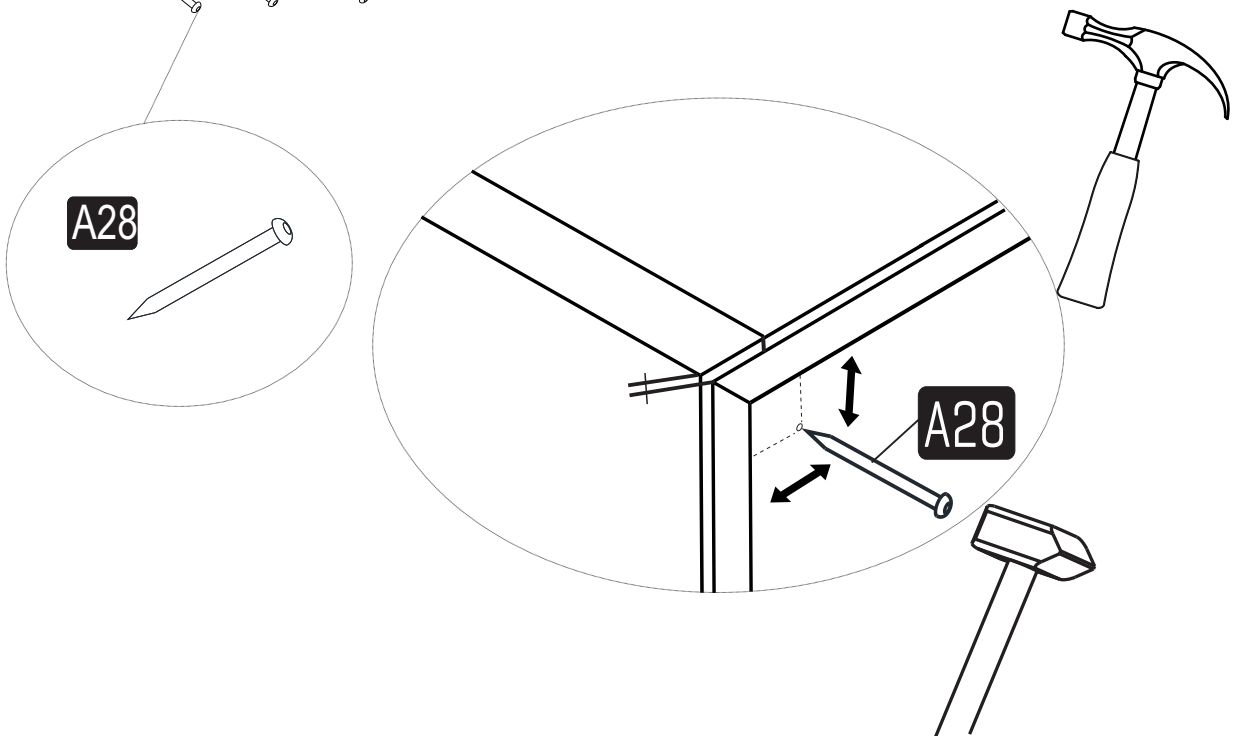

9

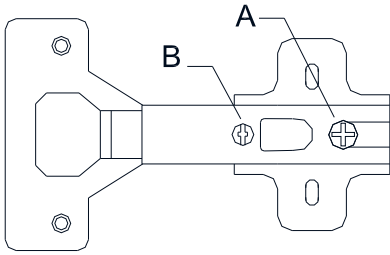
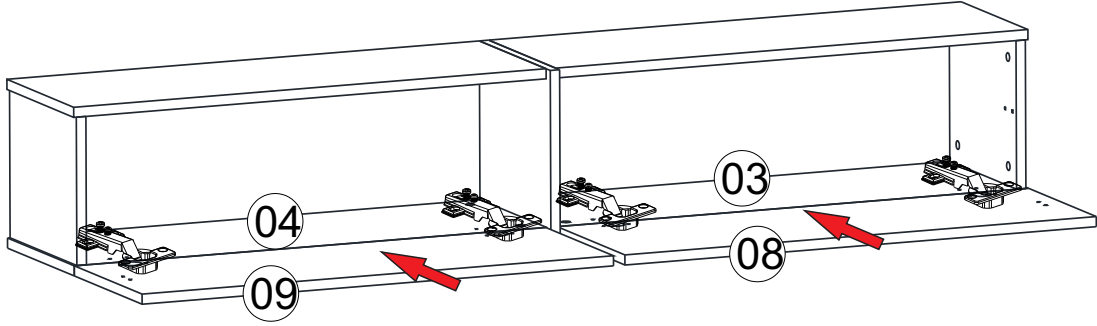
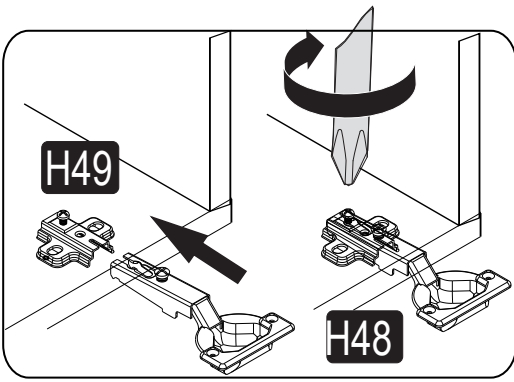

A= menteşe bağlama vidası / to connect the hinge to the door
B= kapak ayar vidası / to arrange the door

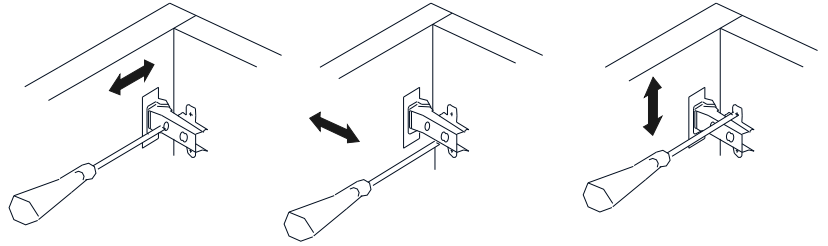

oklar kapağın ayarlama yönünü gösterir.
arrows to show the directions for arrangement of doors.

10

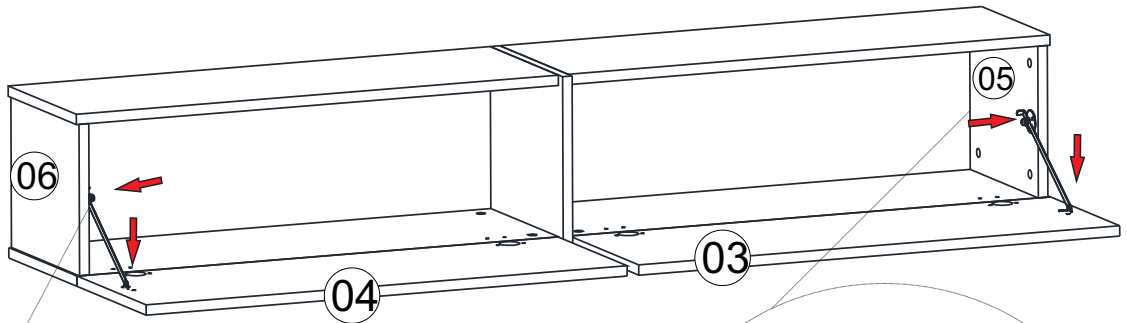

A19

