

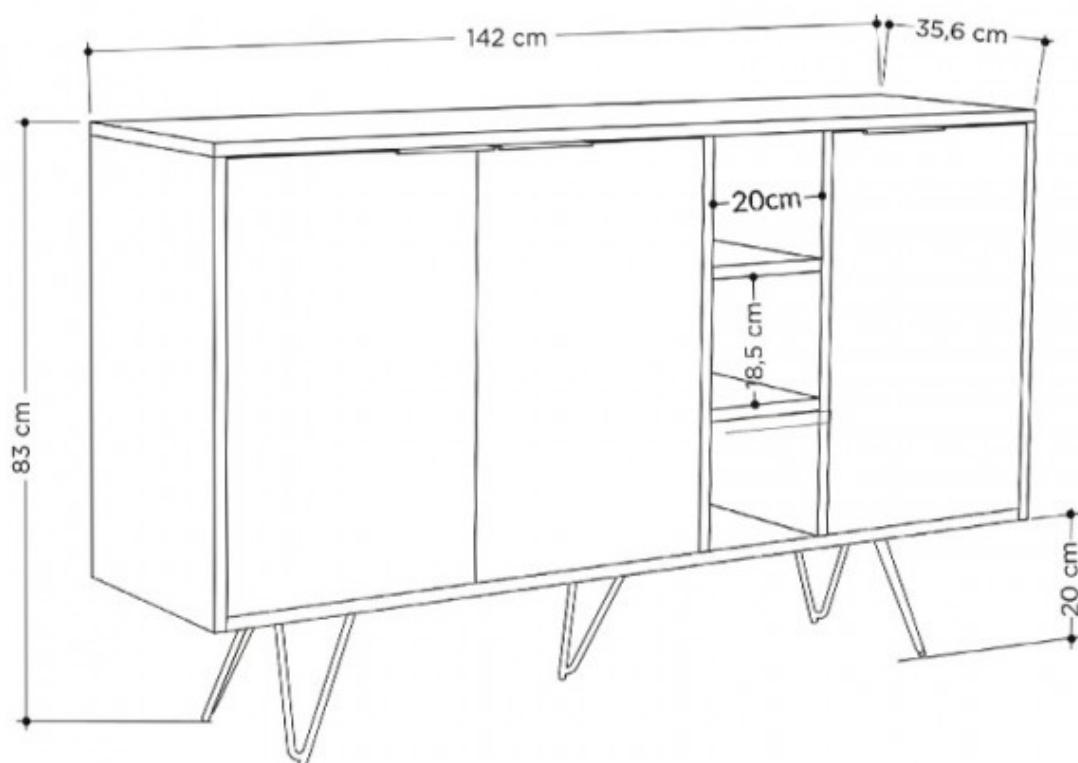









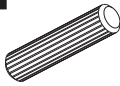

**i** GP037-0004,6

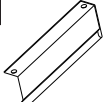
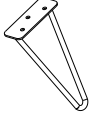

<b>A22</b> Minifix k18  24x	<b>A23</b> Minifix M10  24x	<b>A04</b> Ø8  24x	<b>A13</b> 50mm  8x	<b>A12</b> 4 SW  1x
<b>C19</b> SdbF(S)  3x	<b>C16</b> Sdb(S)  3x	<b>C20</b> Mtk(S)  6x	<b>A18</b> 3,5x18  54x	<b>Z51</b> K128mm (black)  3x
<b>Z88</b> MBA  5x	<b>B15</b> 15 (black)mm  15x	<b>A69</b> P.D.  15x	<b>A06</b> 18mm  32x	<b>A25</b> ARK.PL  12x

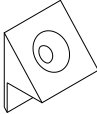
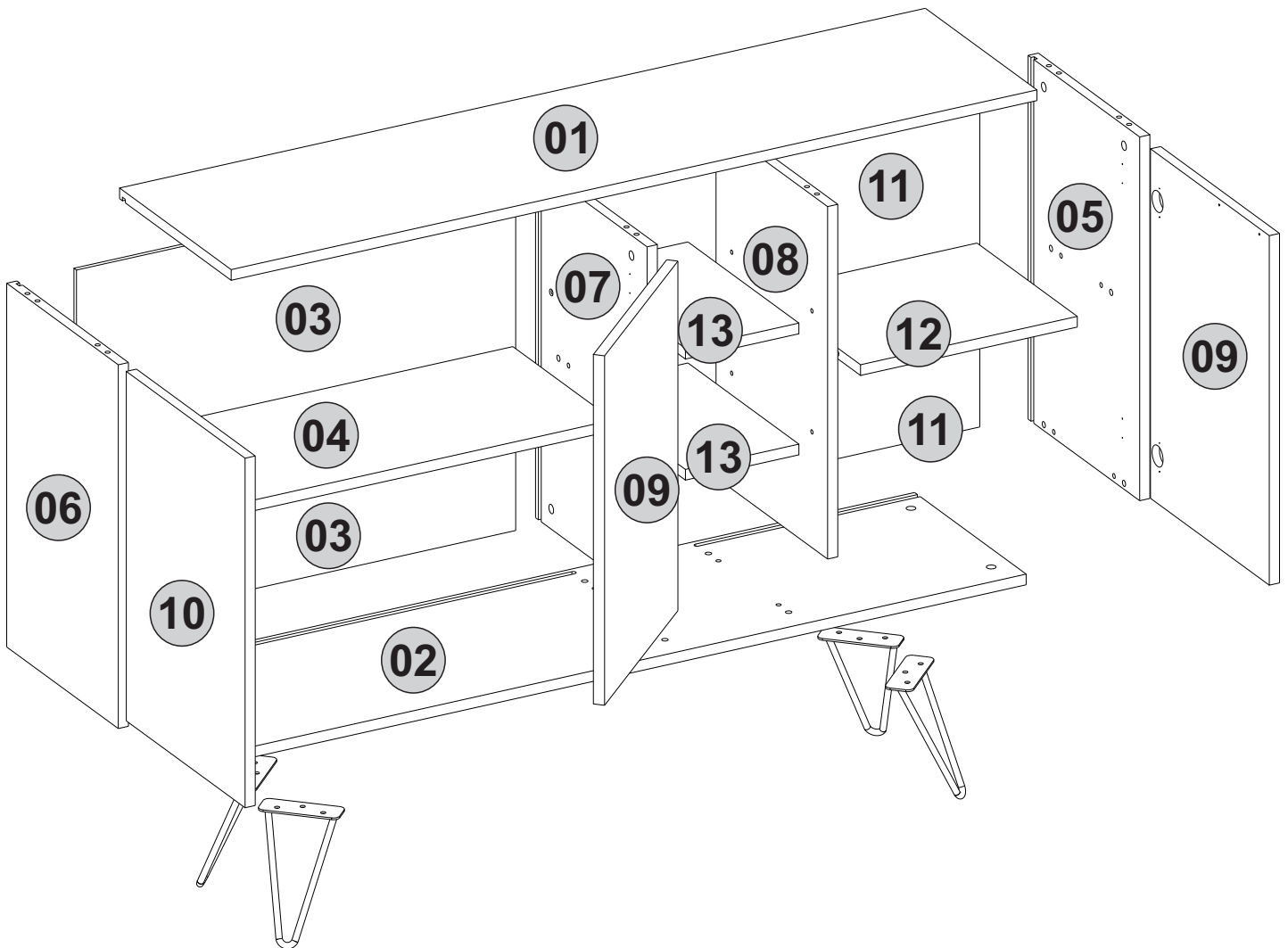

# 1. step

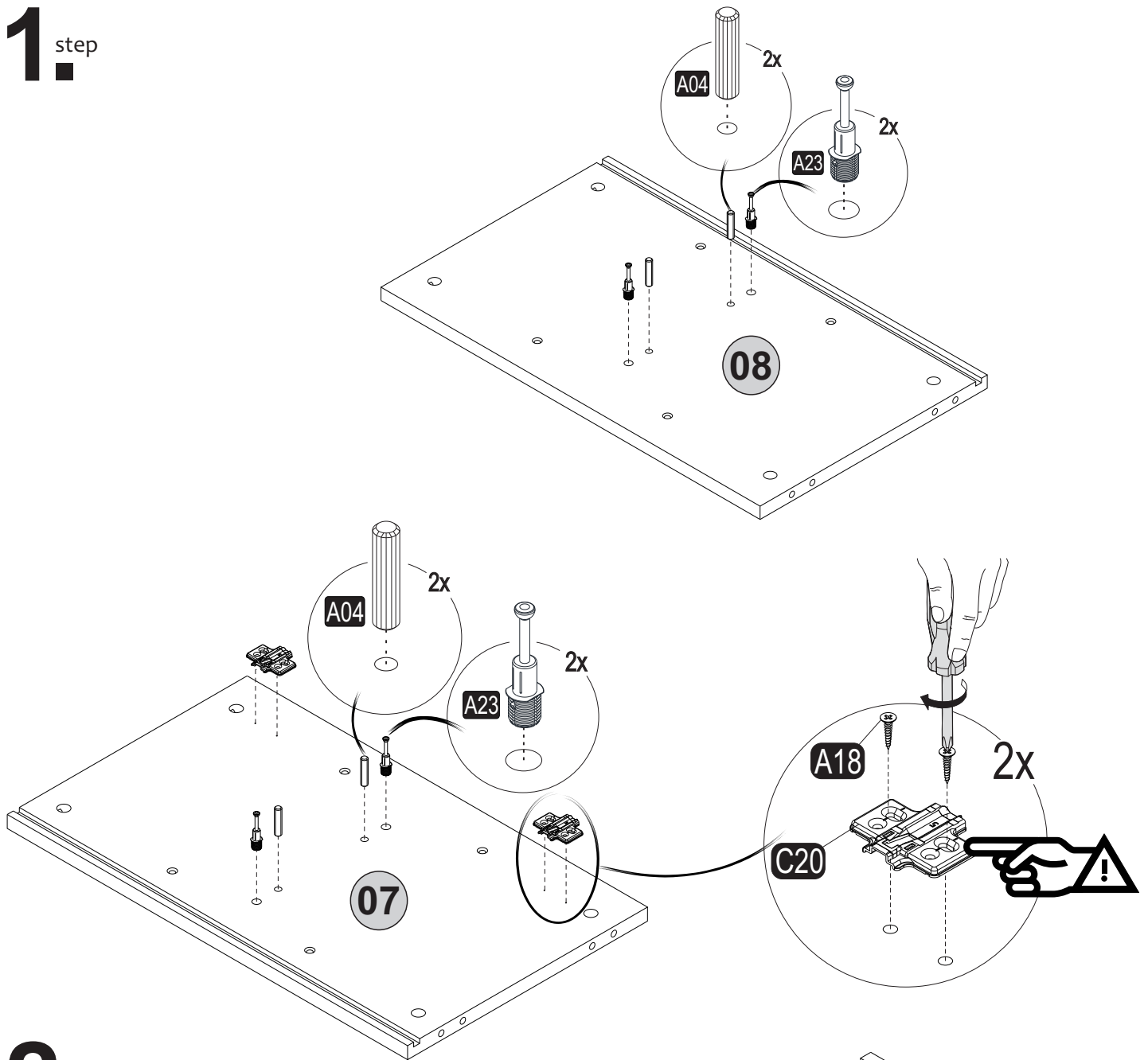

# 2. step

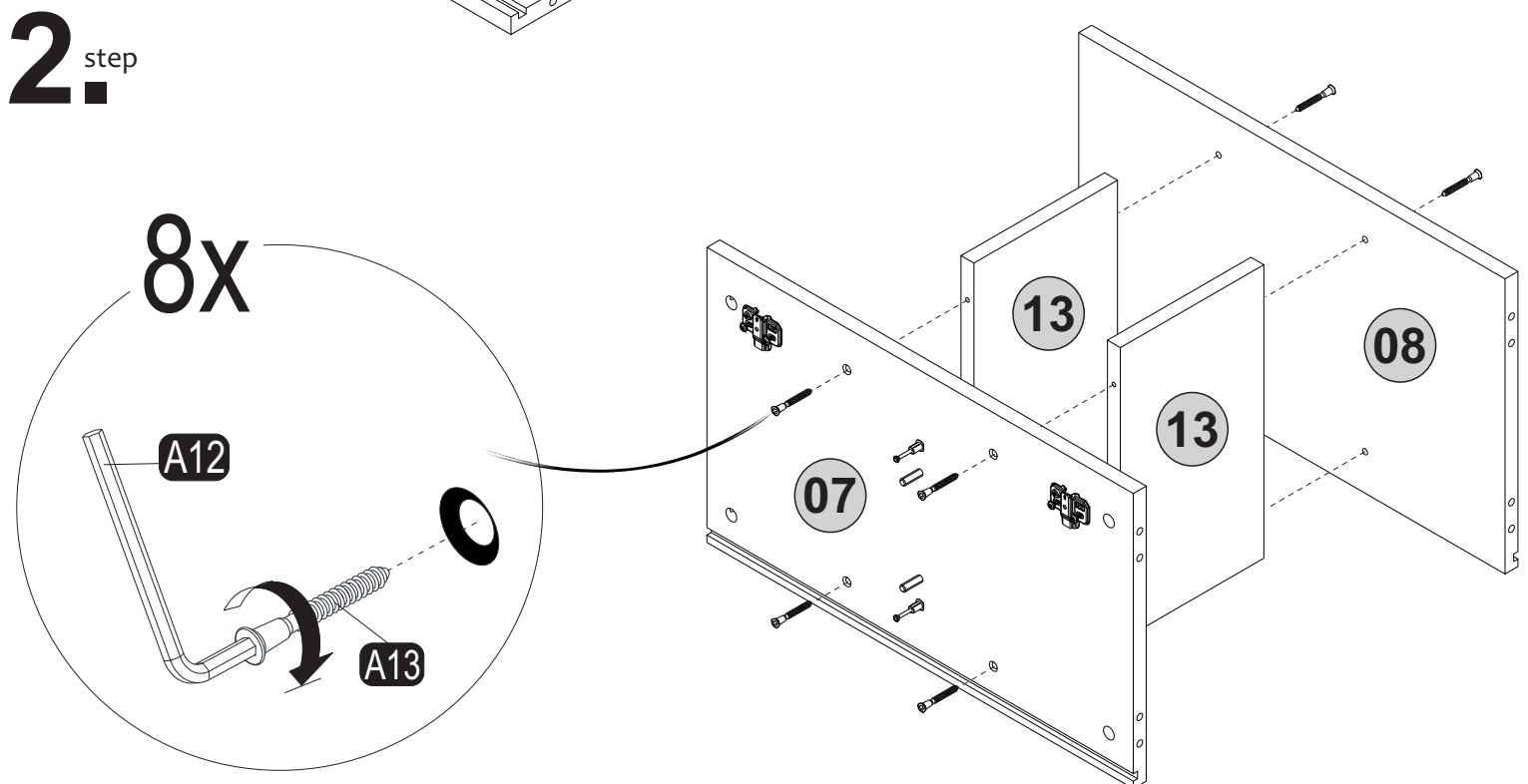

# 3 step

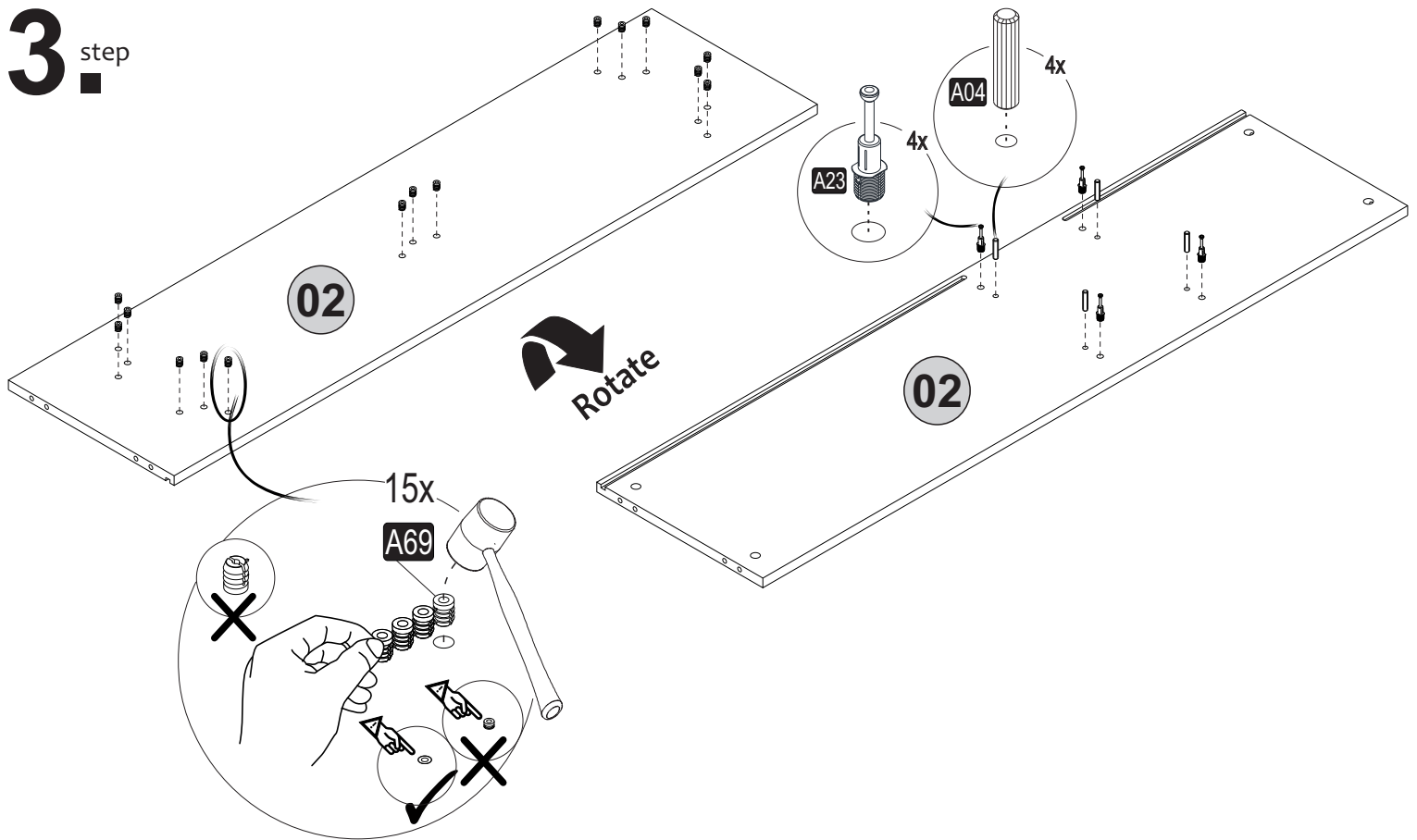

# 4 step

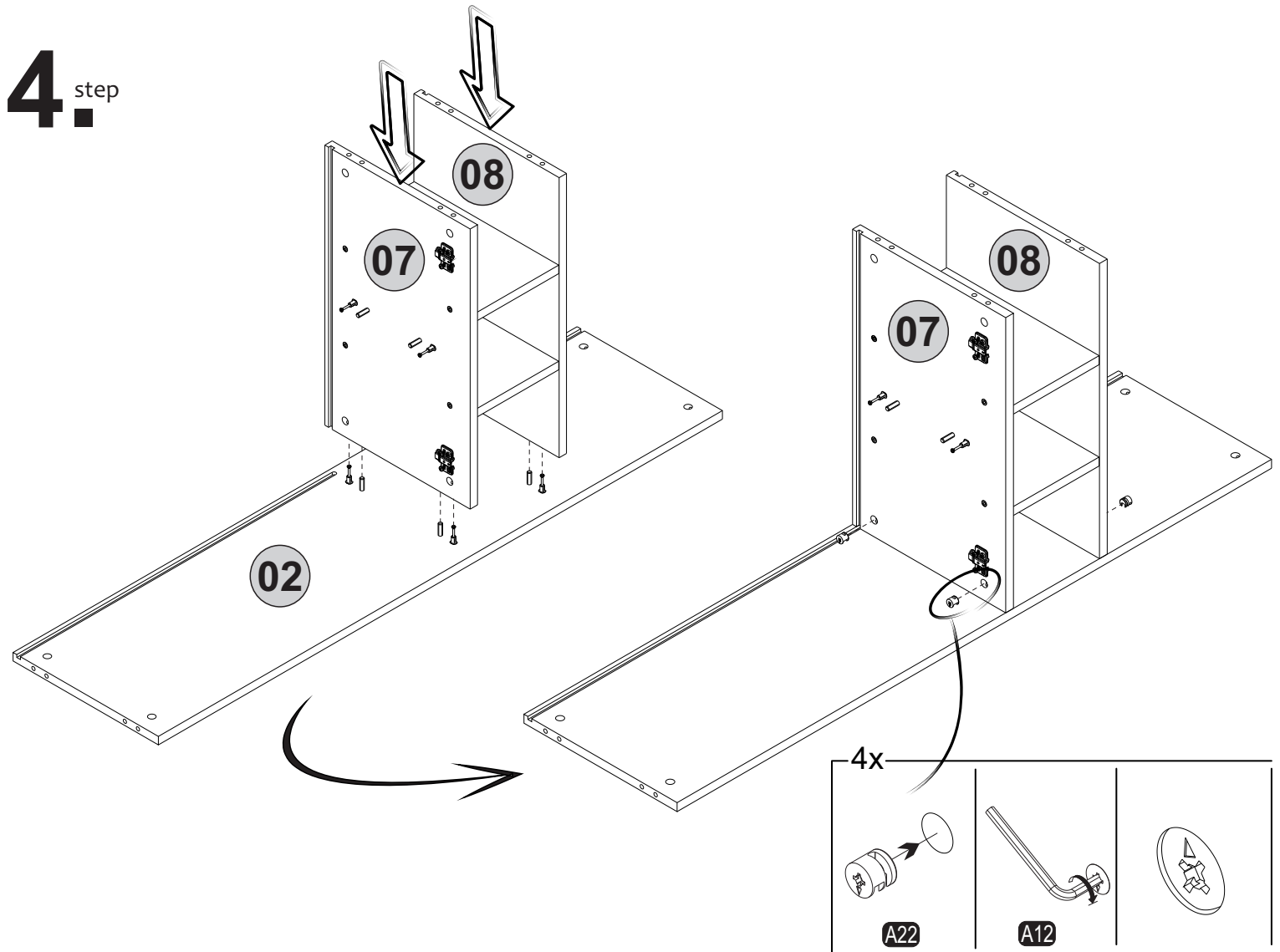

# 5.<sup>step</sup>

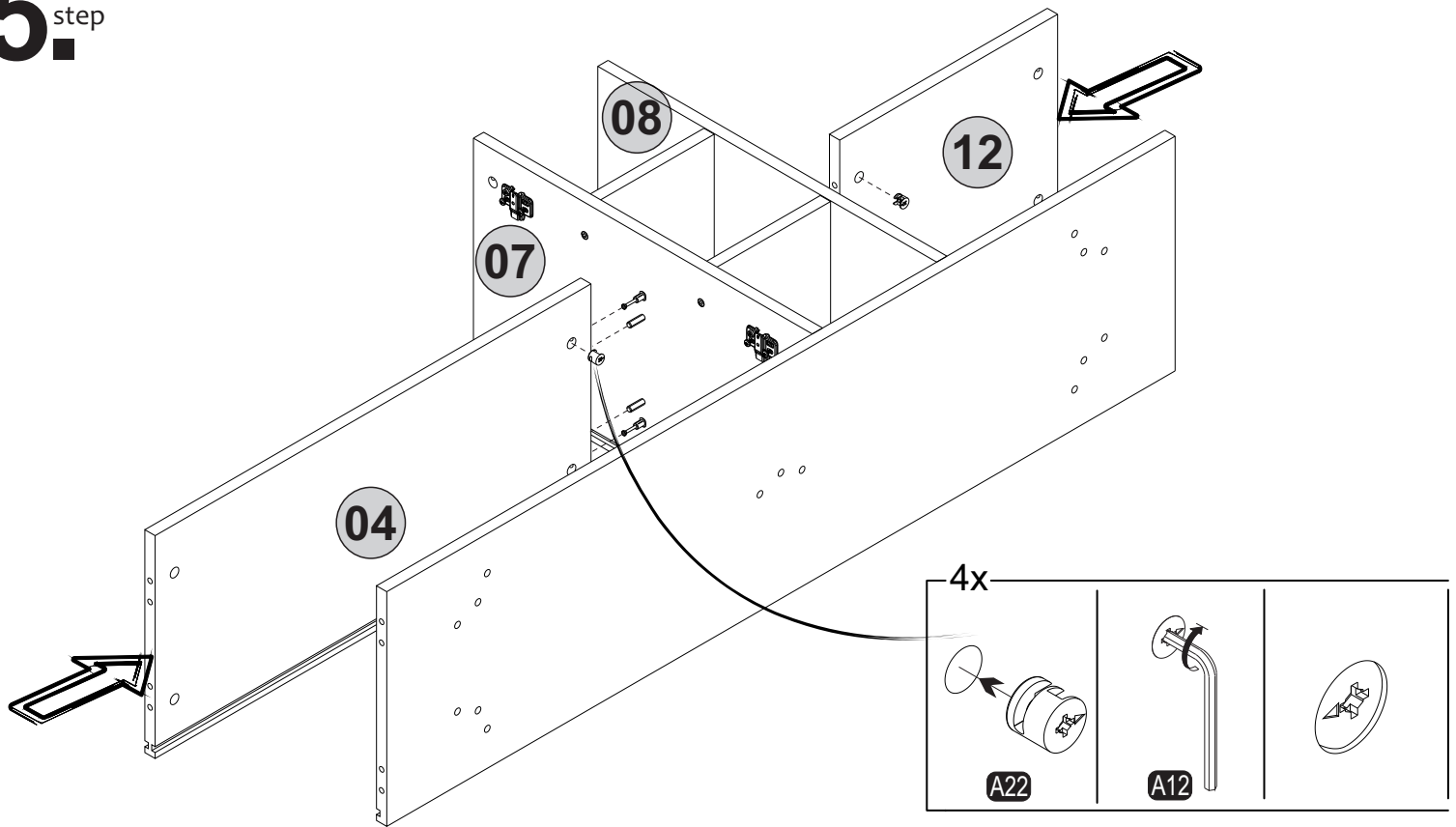

# 6.<sup>step</sup>

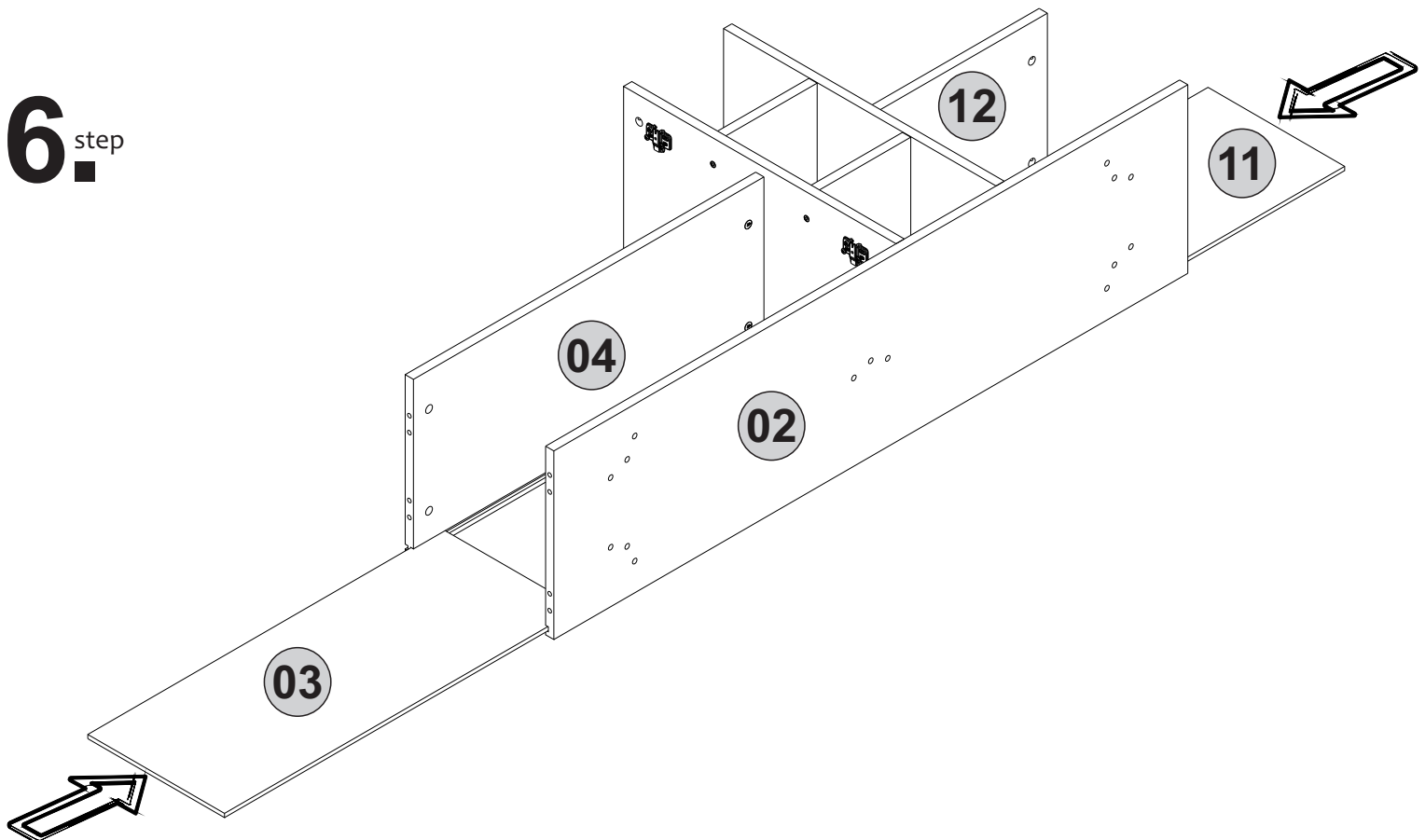

# 7. step

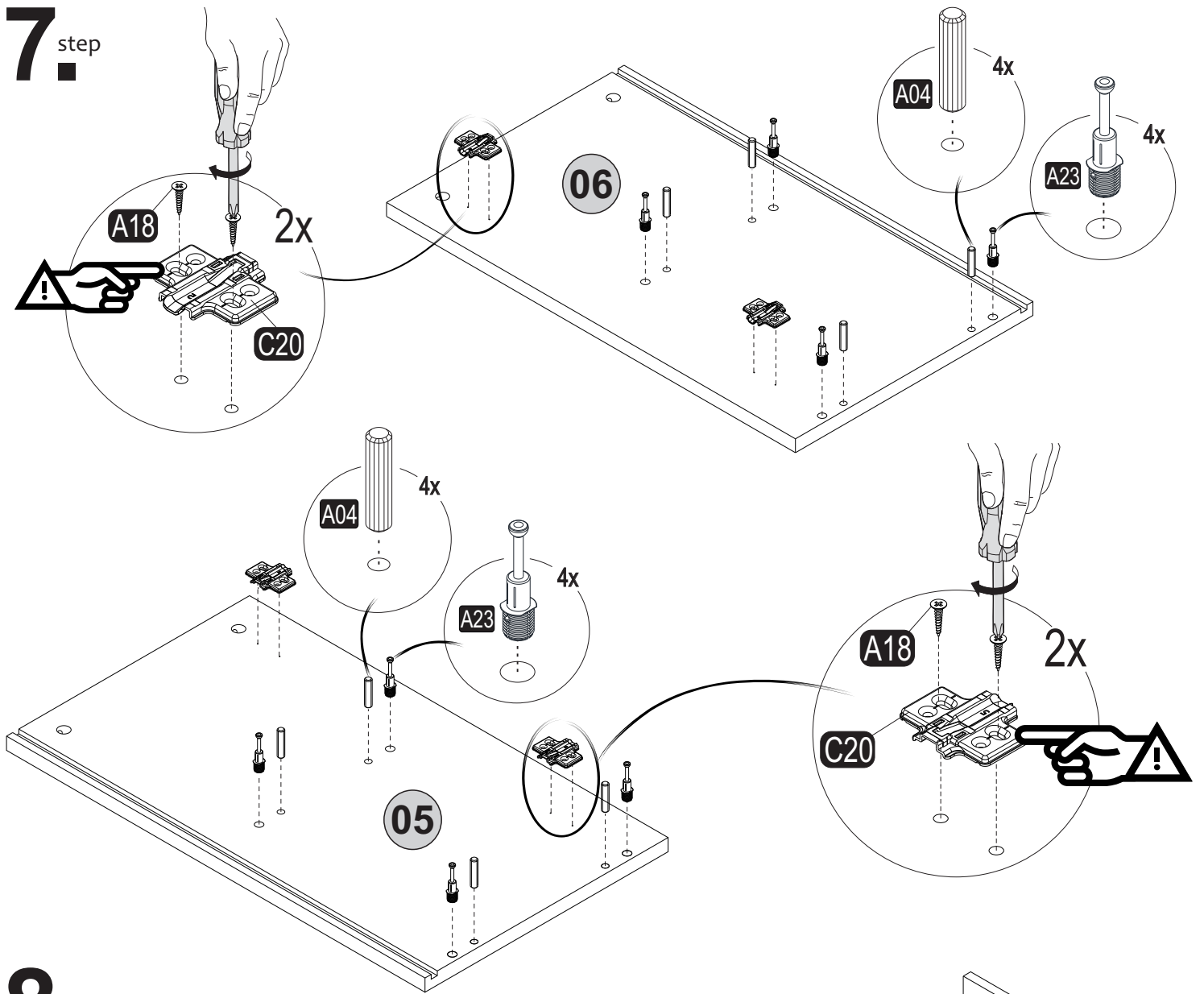

# 8. step

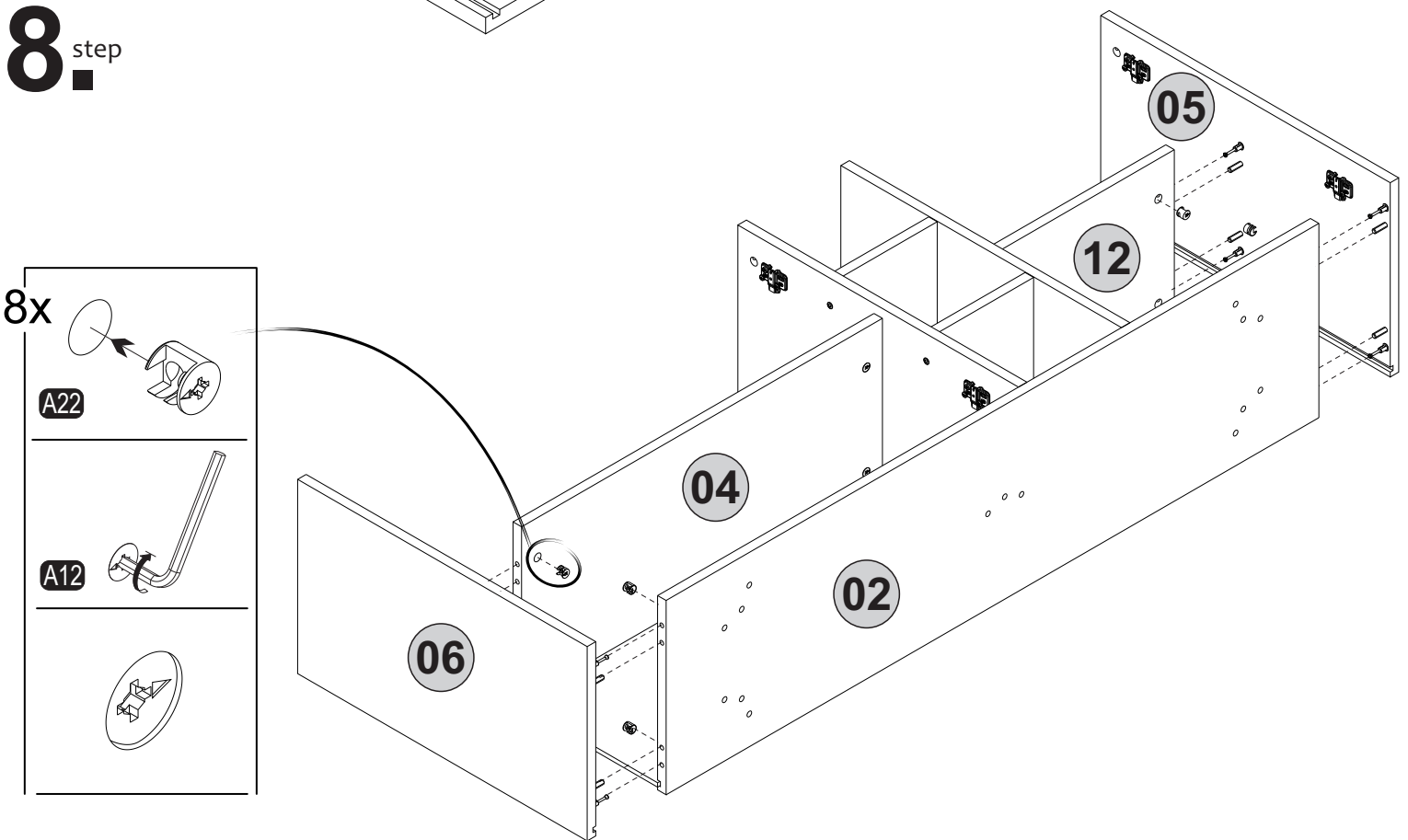

# 9<sup>step</sup>

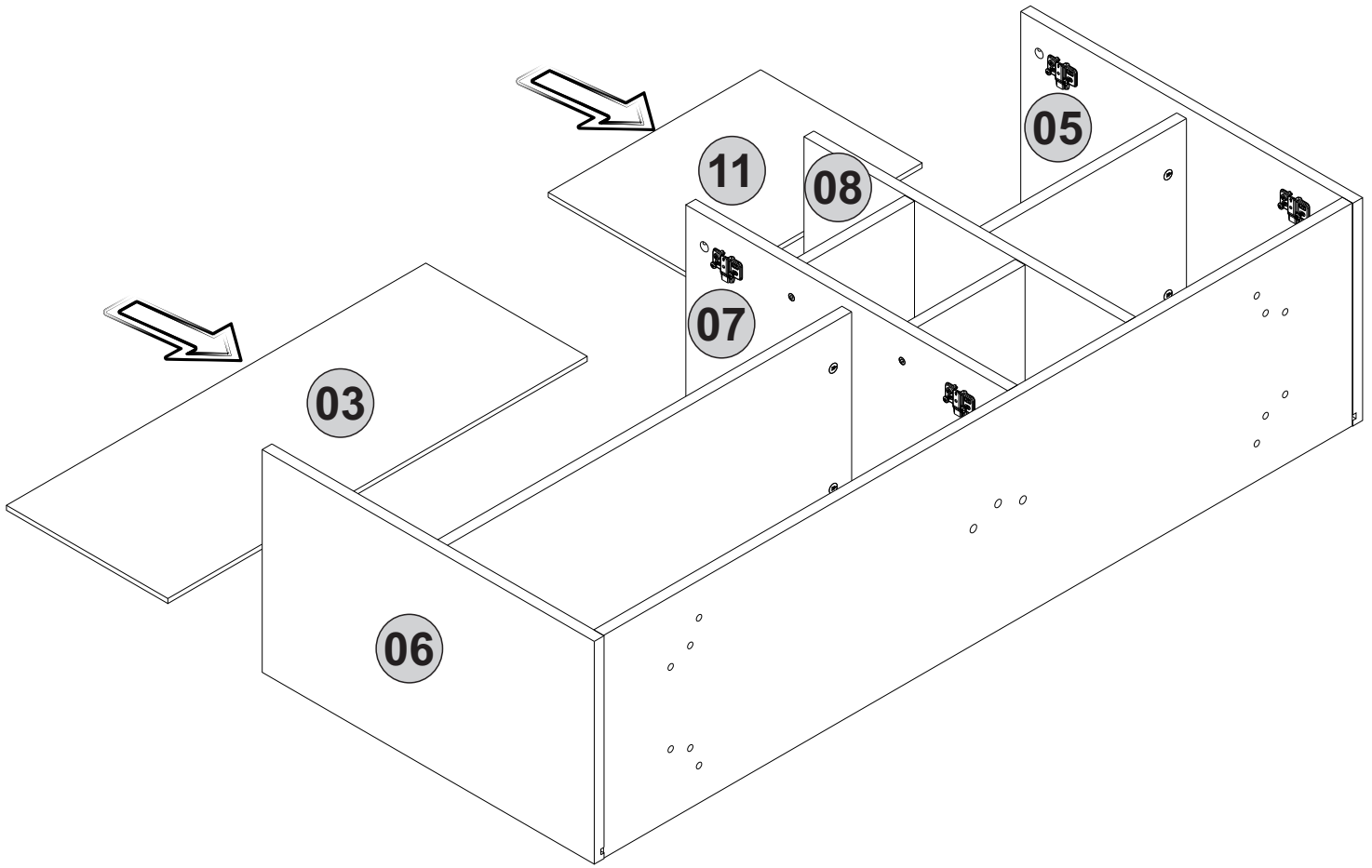

# 10<sup>step</sup>

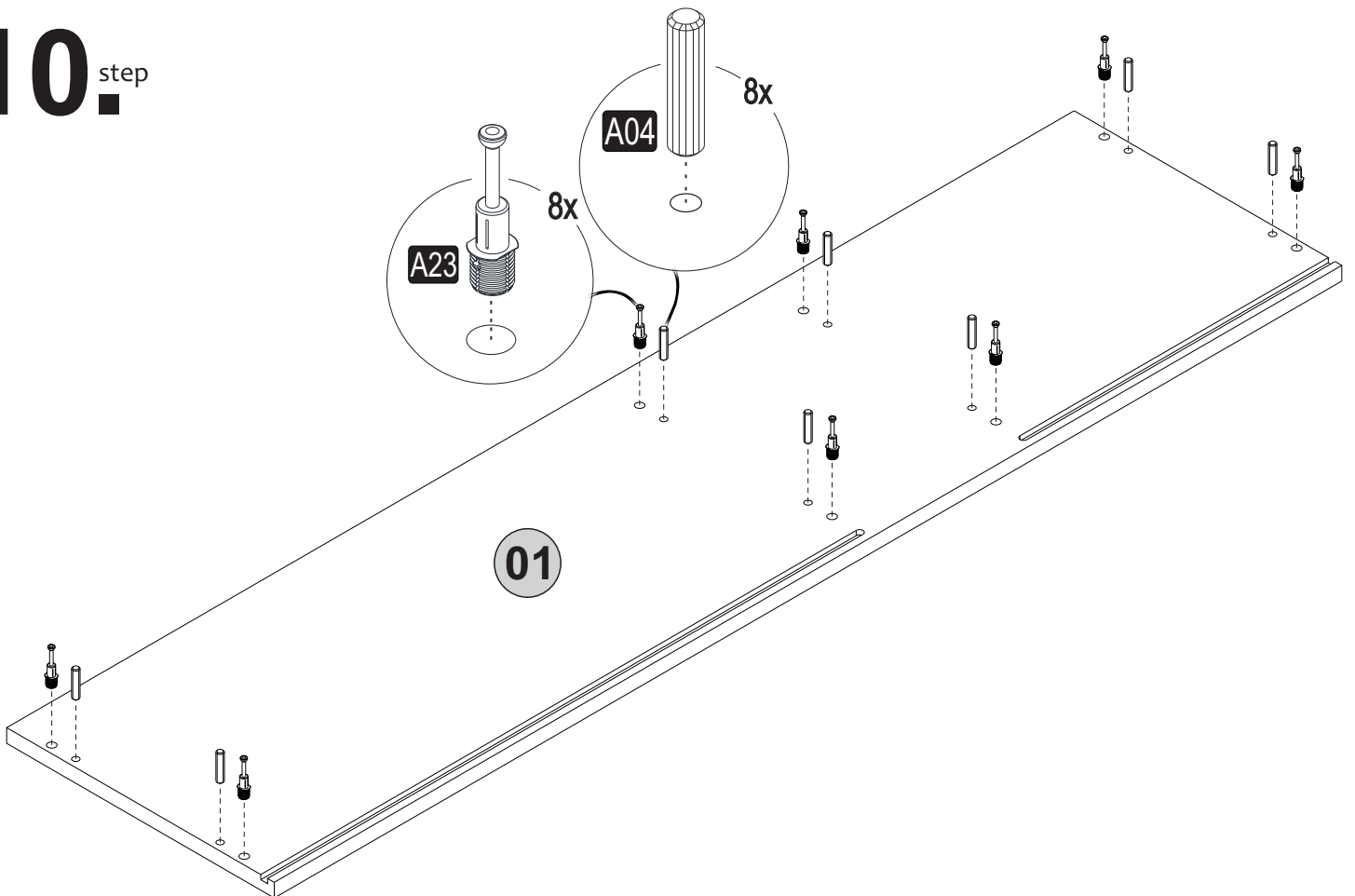

# 11. step

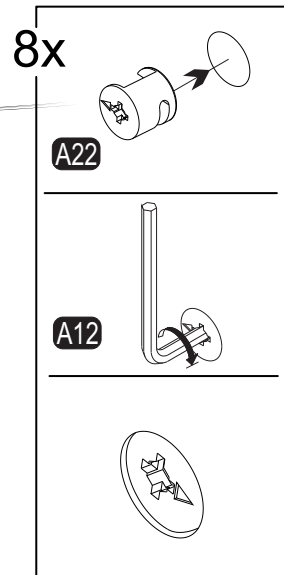
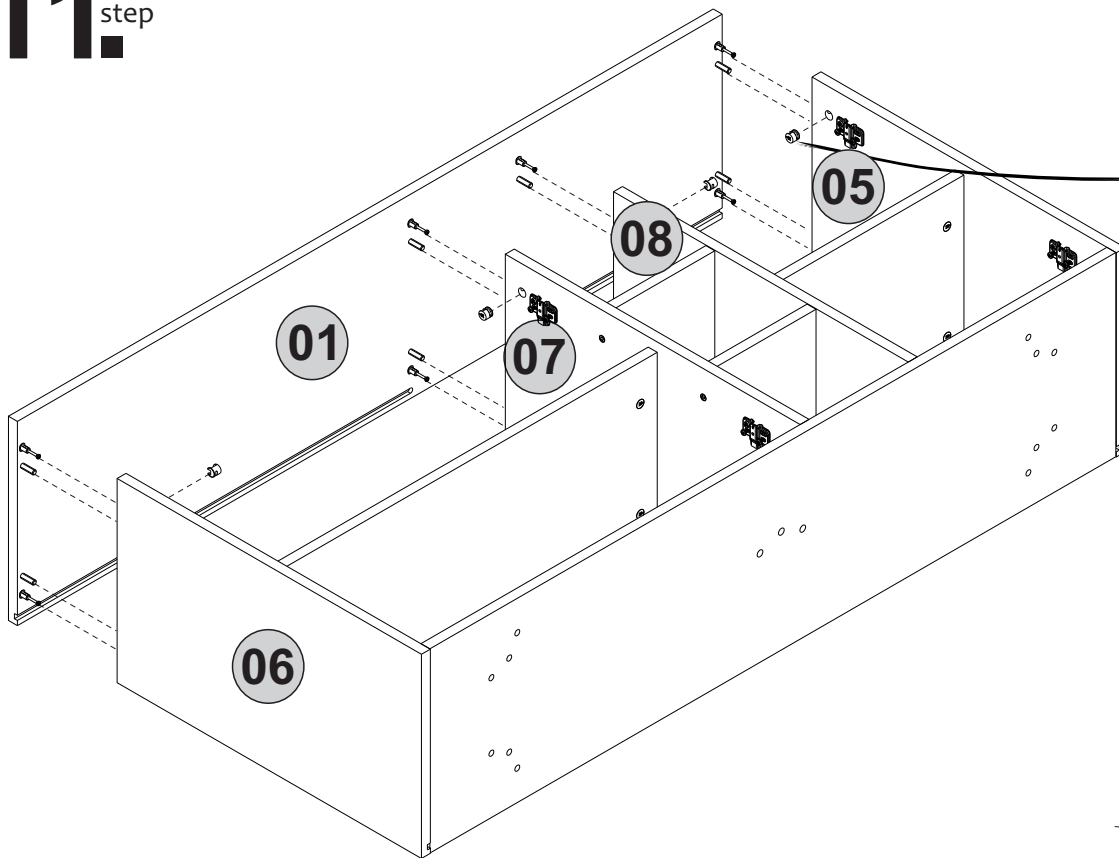

# 12. step

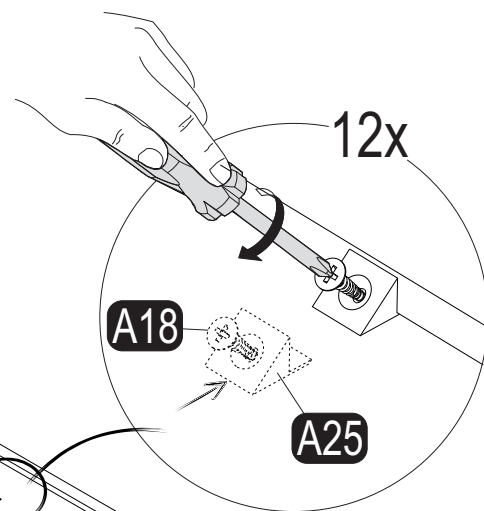
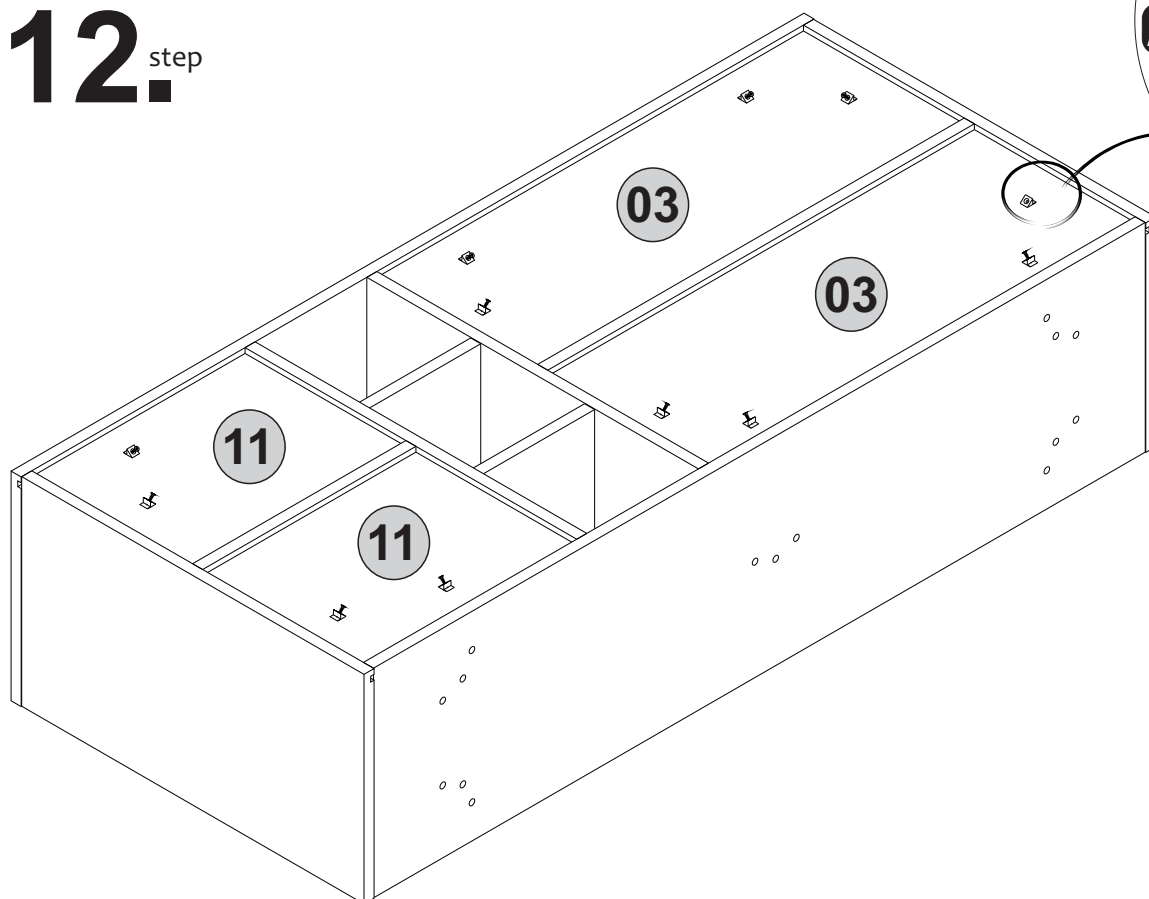

# 13.<sup>step</sup>

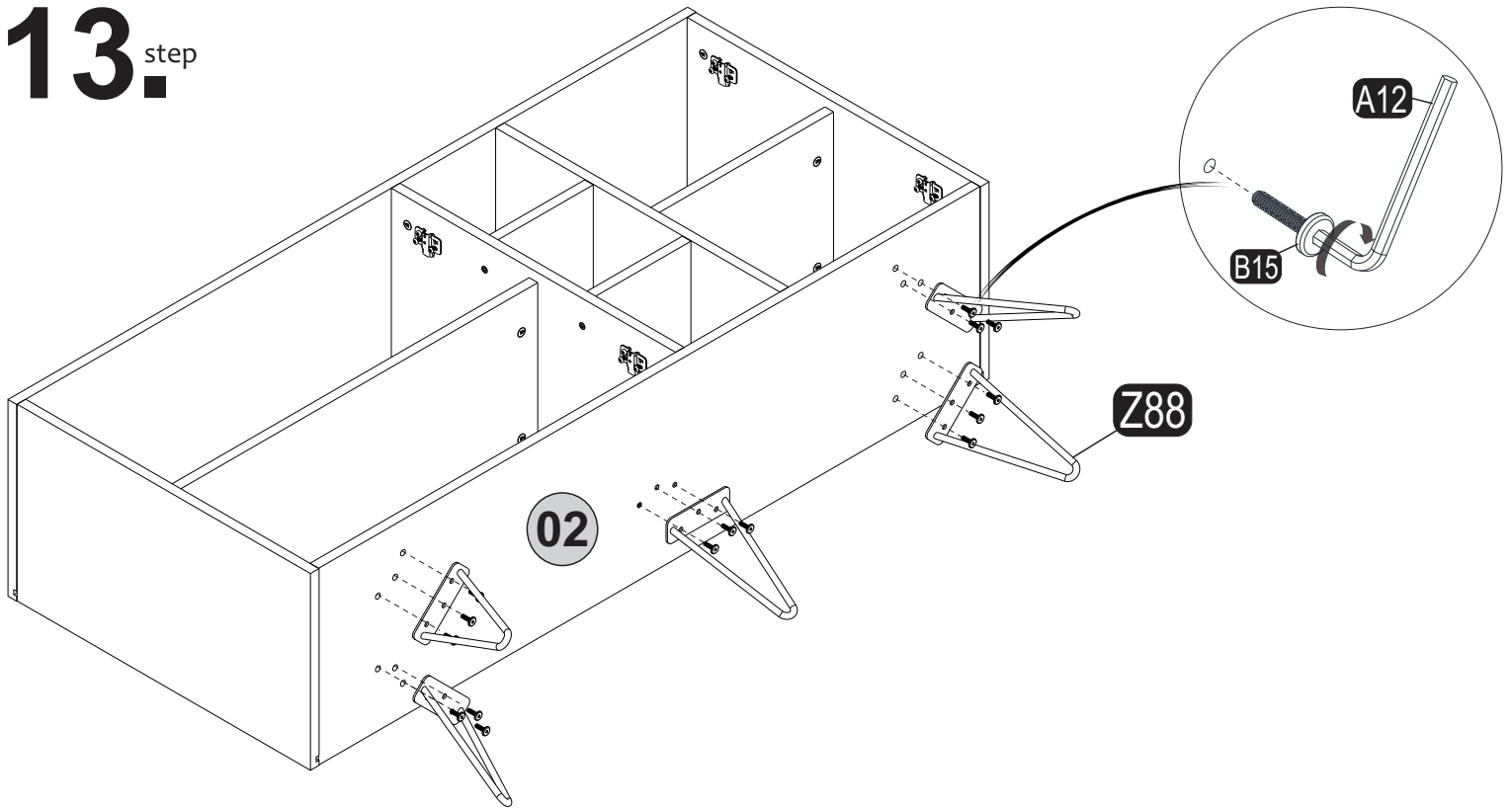

# 14.<sup>step</sup>

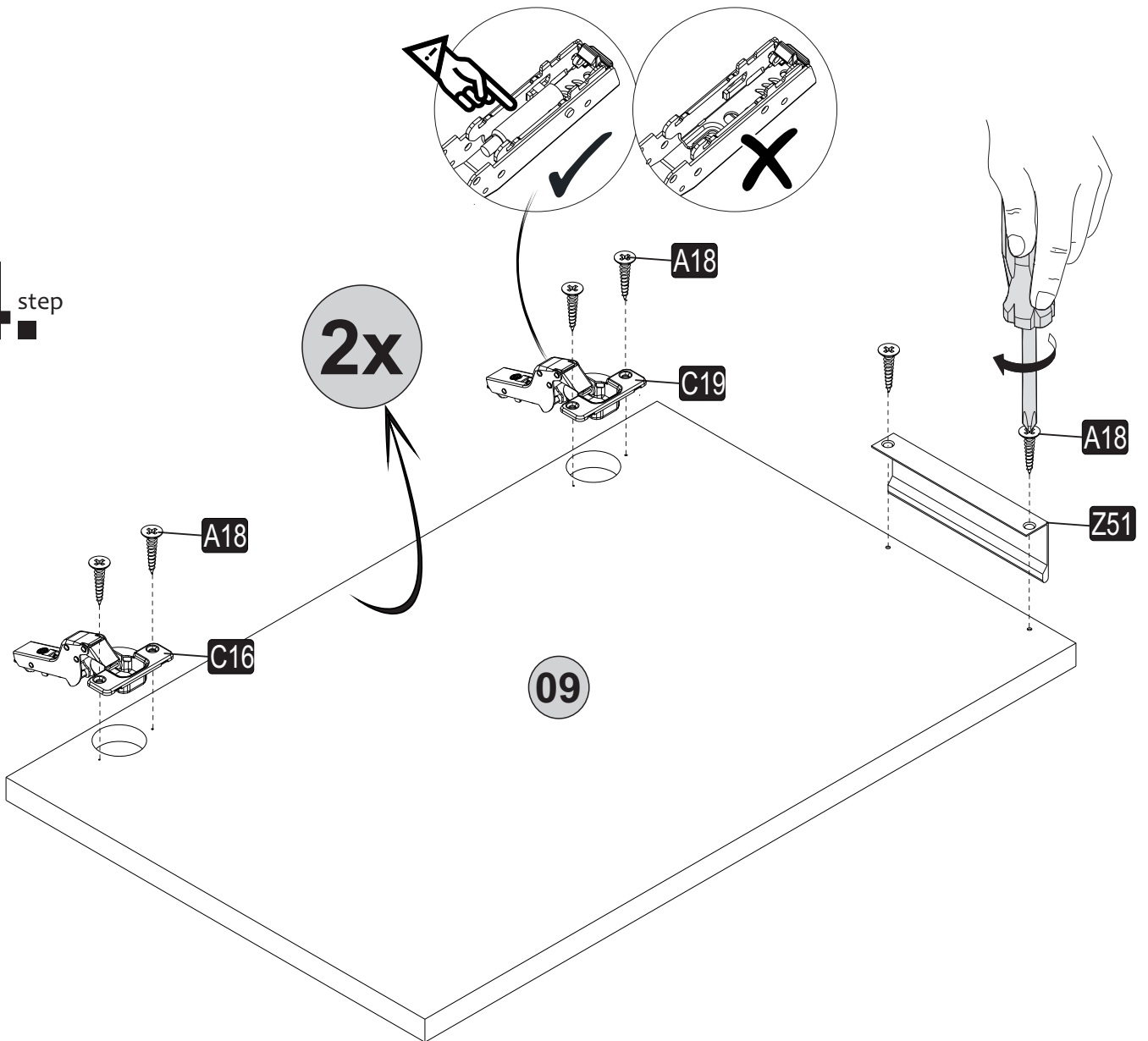

# 15<sup>step</sup>

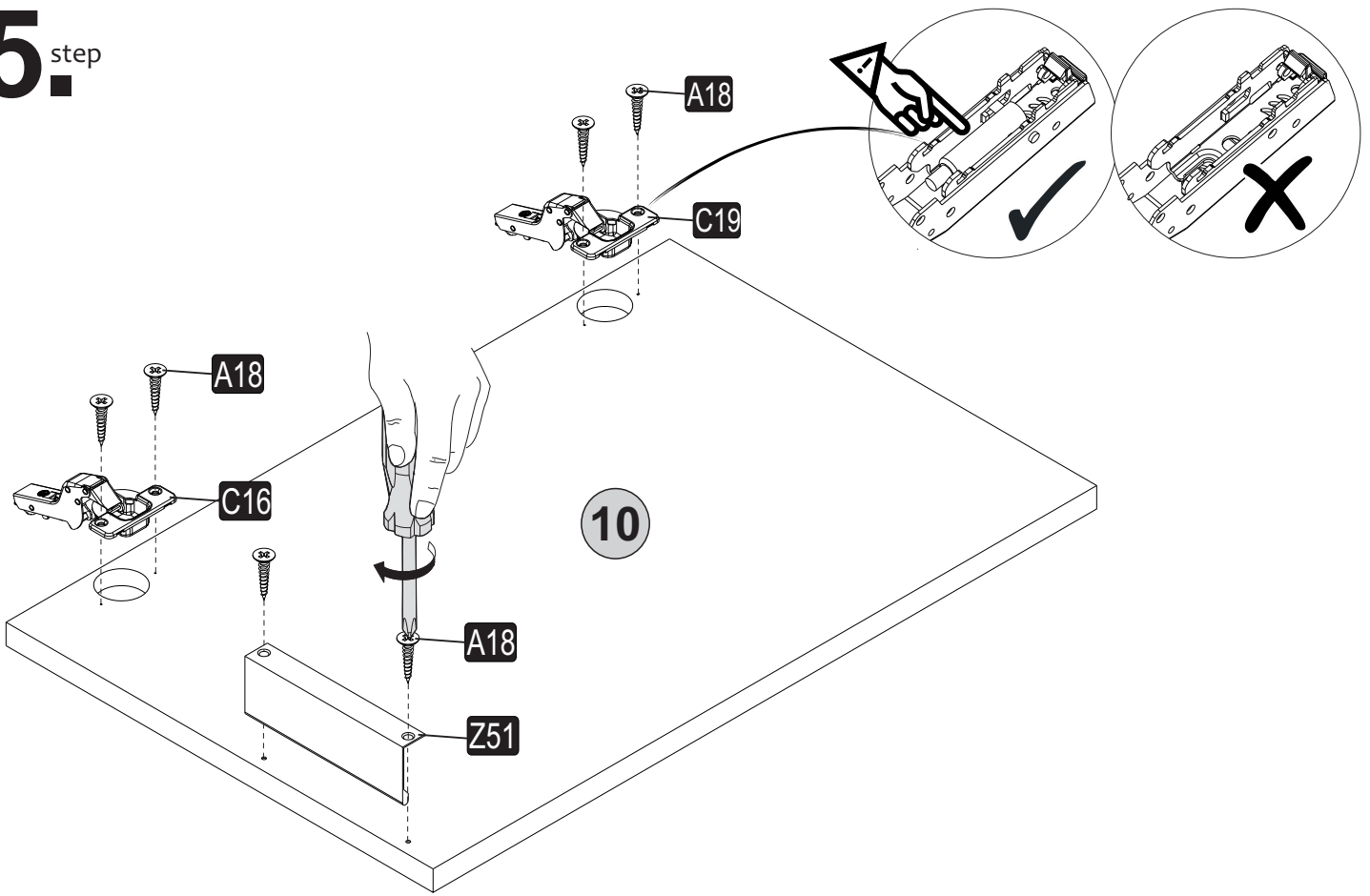

# 16<sup>step</sup>

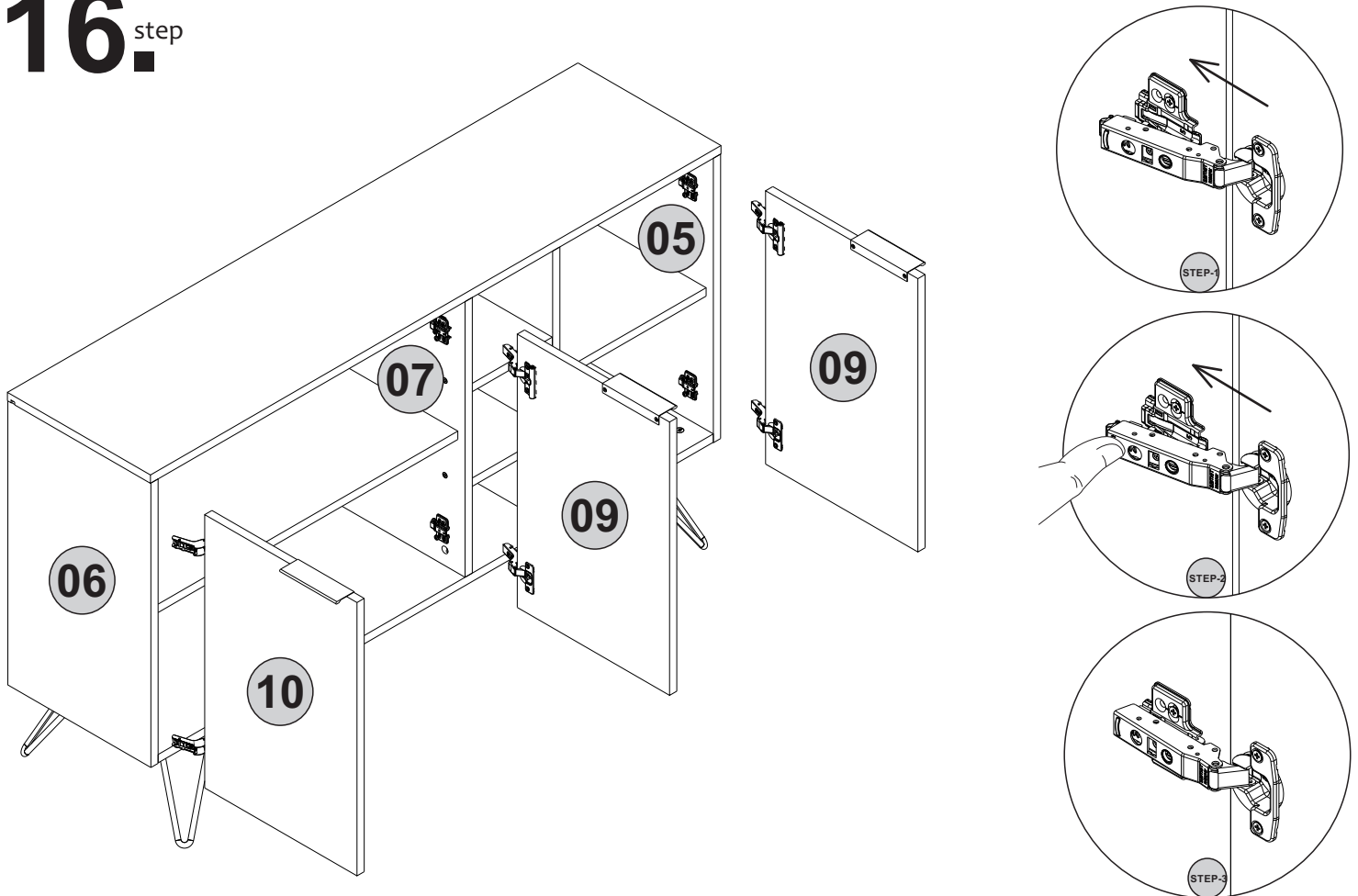

# 17. step

