

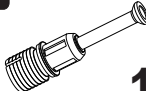

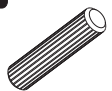

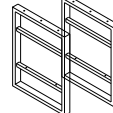





i GP042-0228,3

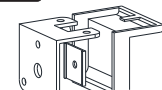

138,8 x 41 x 75,7cm

A01  12x	A02  12x	A03  12x	F54  DKR-355 H512*390*40 1x	A28  31x
A13 MA  4x	A12 DM  4x	A04  A 12x	A10 3,5x18 YHB  18x	C36 M6X30  10x
A17 4mm  1x	A41 Dolap Askı “L” Demiri  1x	D41 5x70 YHB  1x	D69 Ø8  1x	

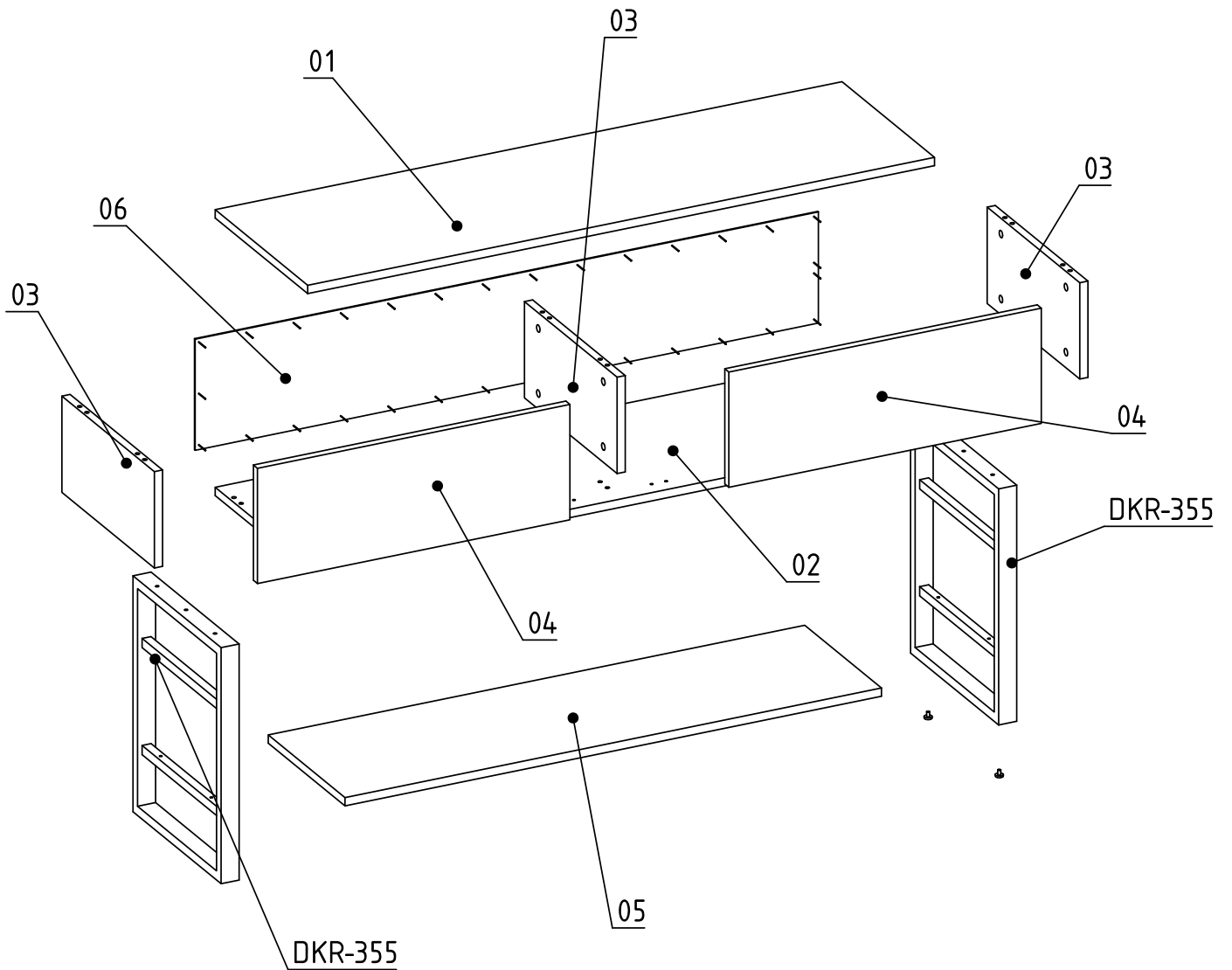

1

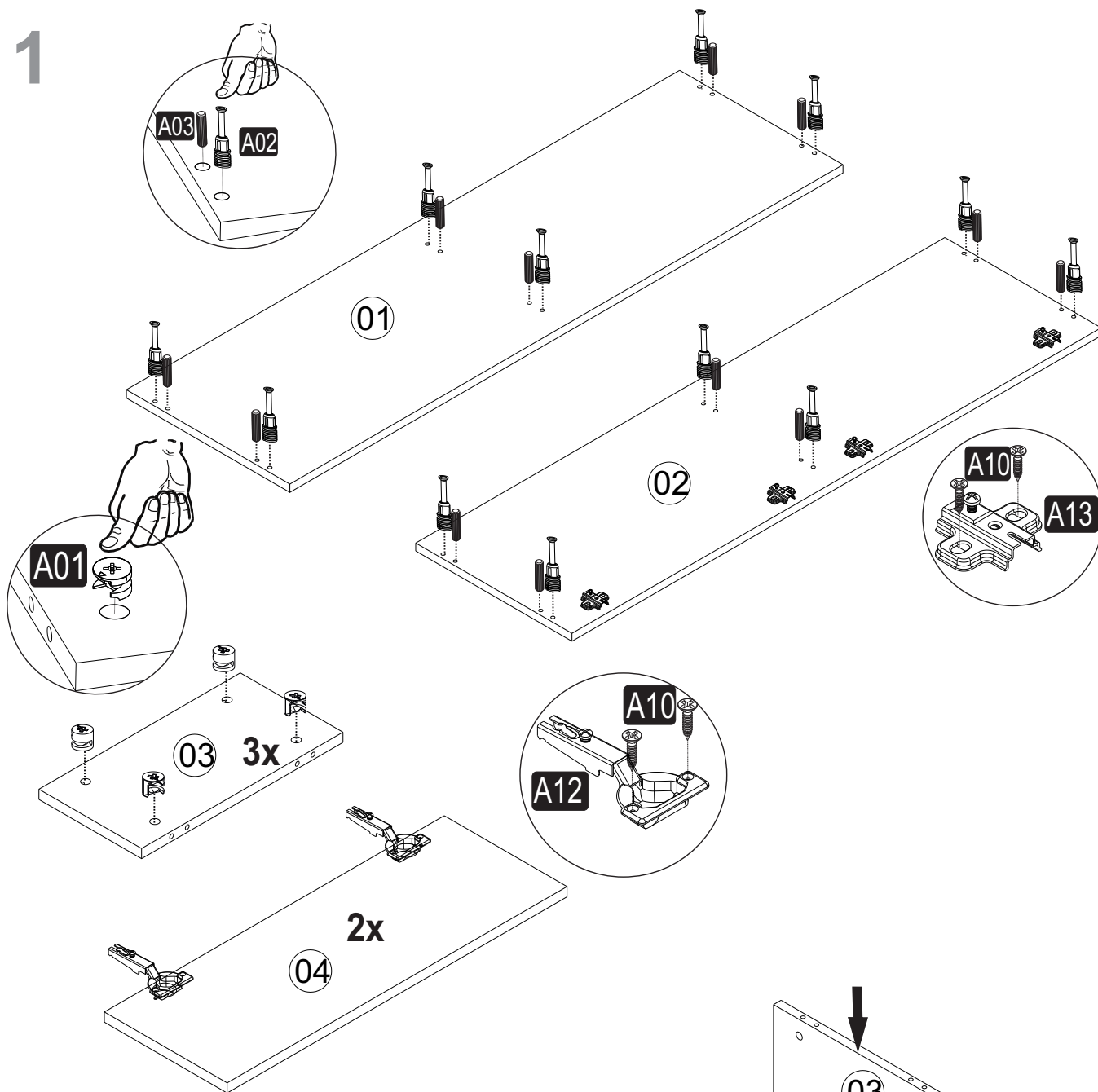

2

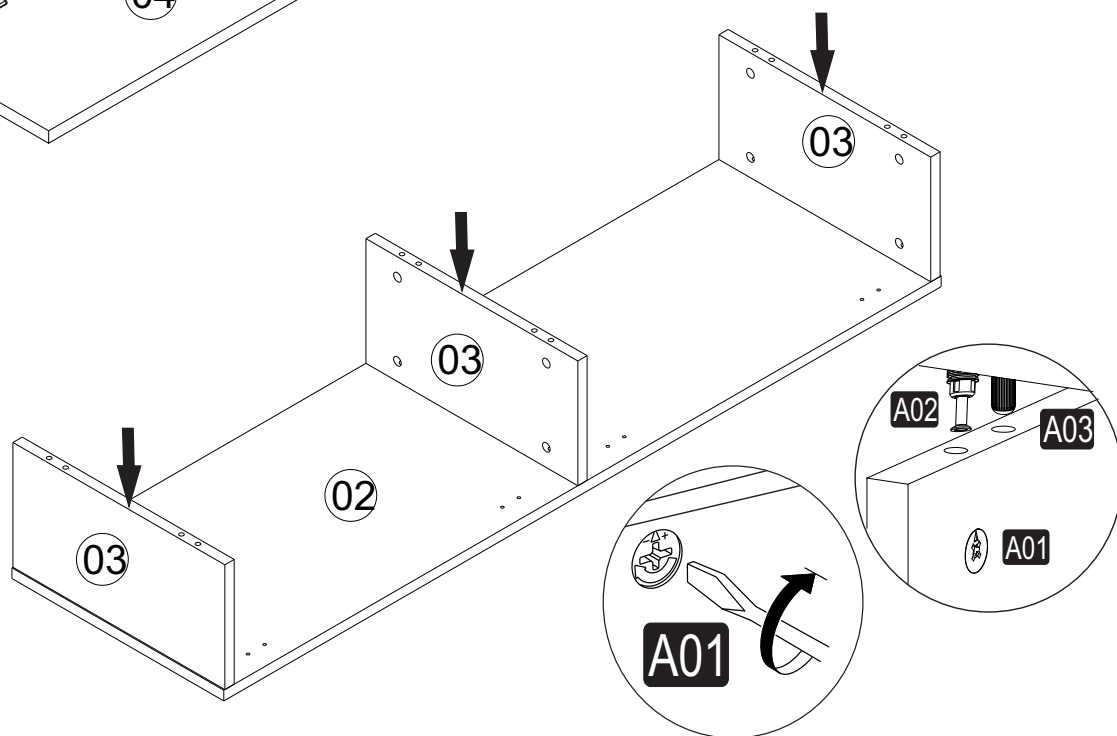

3

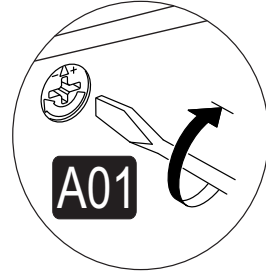
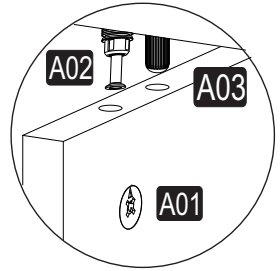
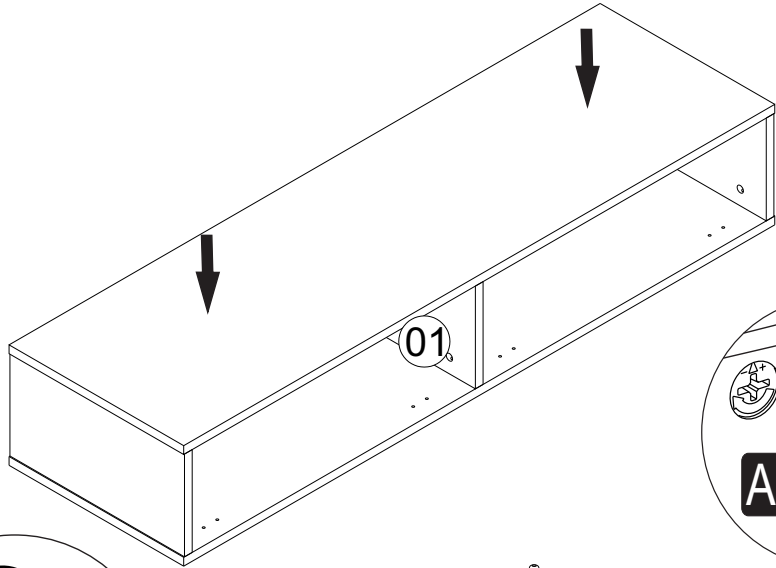

4

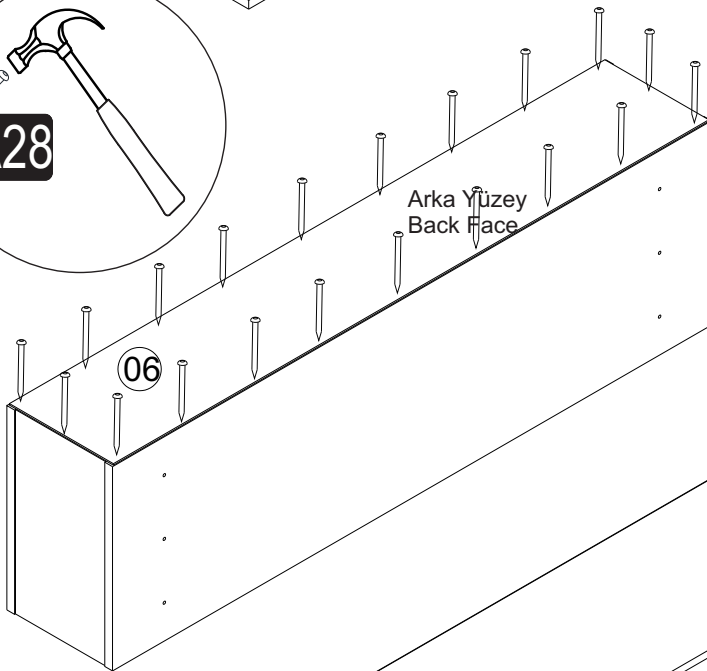

5

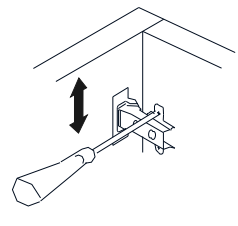
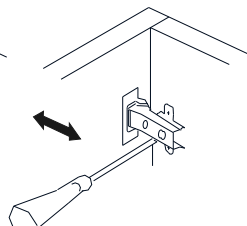
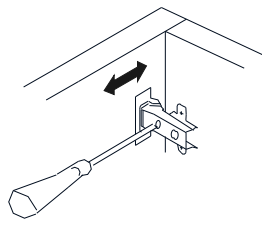
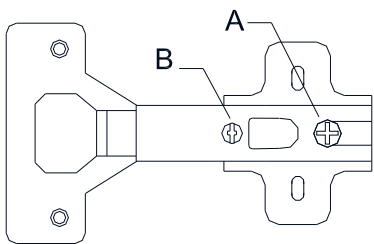
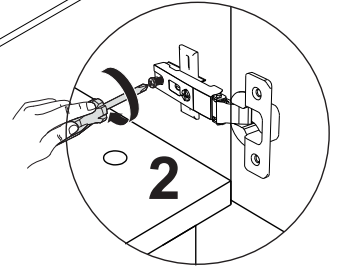
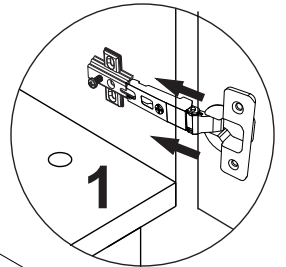
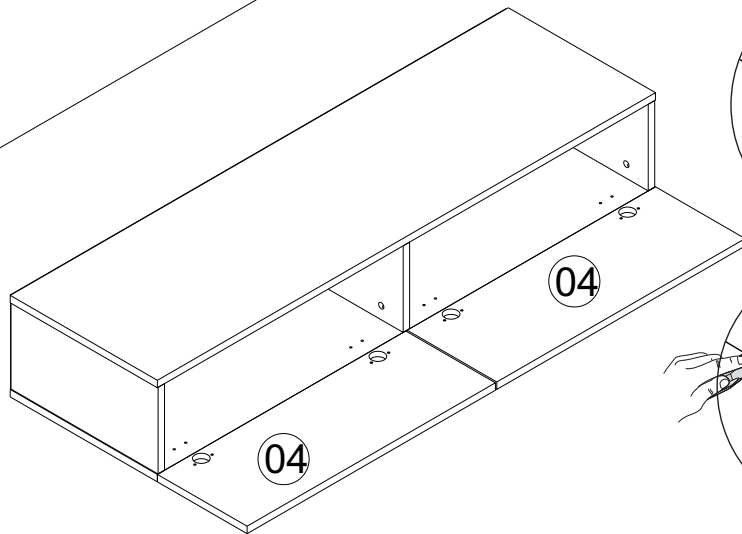

A=
B=

/ to connect the hinge to the door
/ to arrange the door

arrows to show the directions for arrangement of doors.

6

6

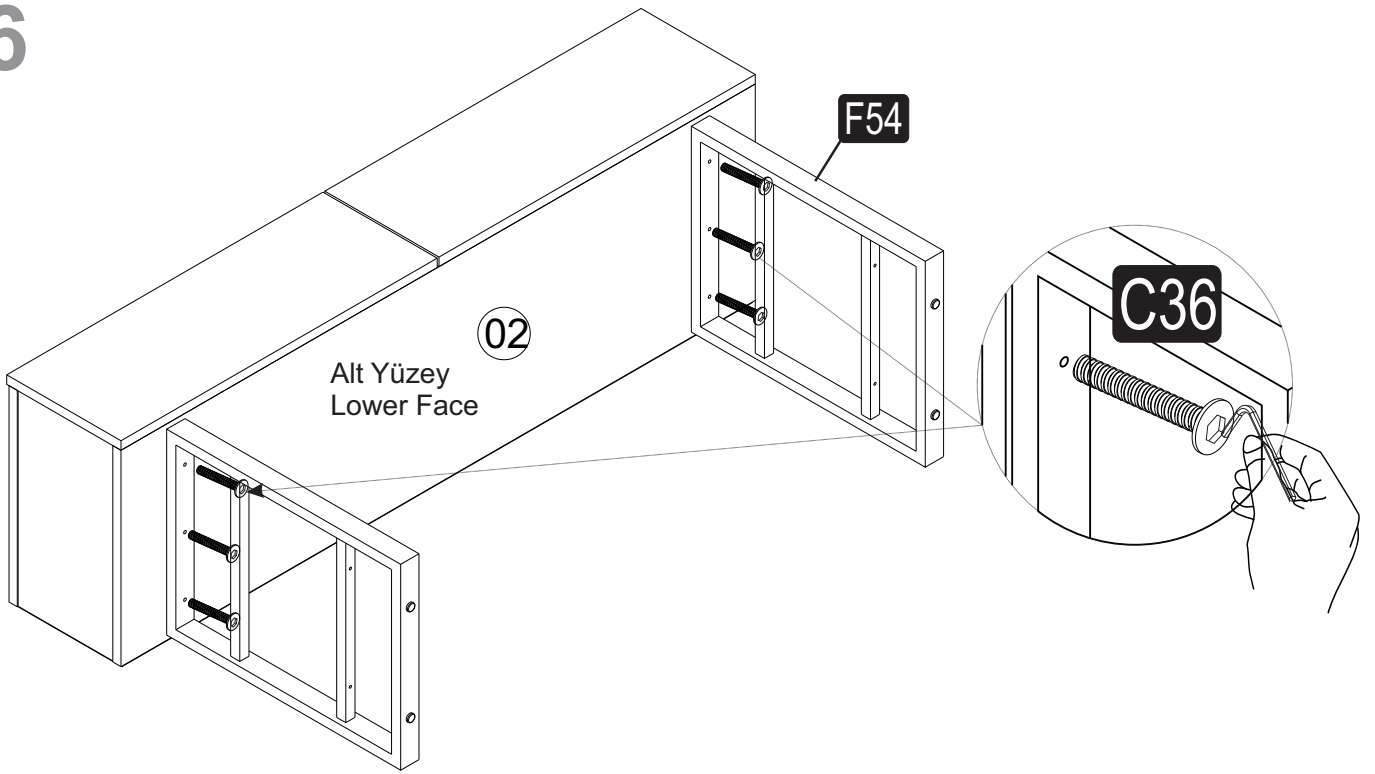

7

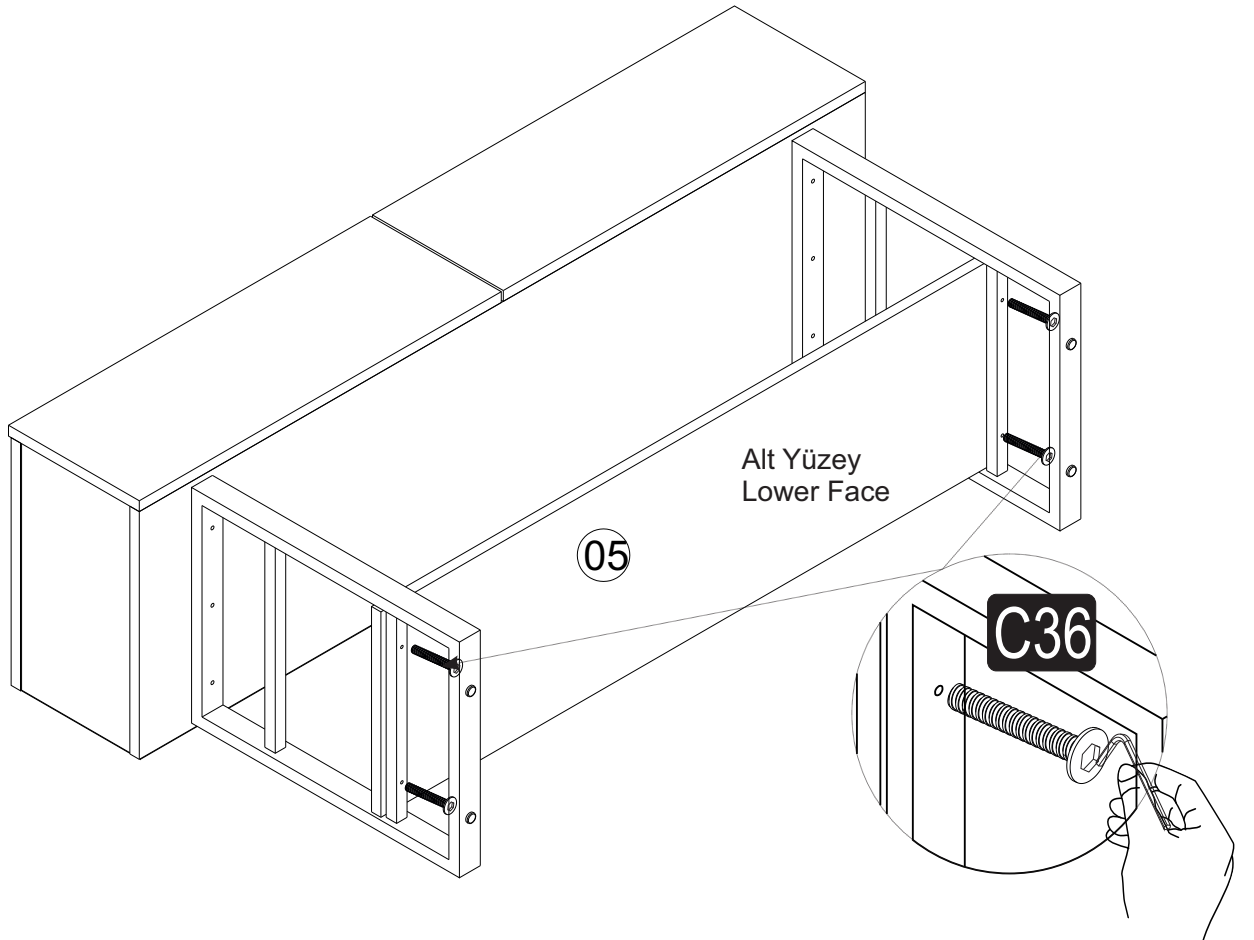

8

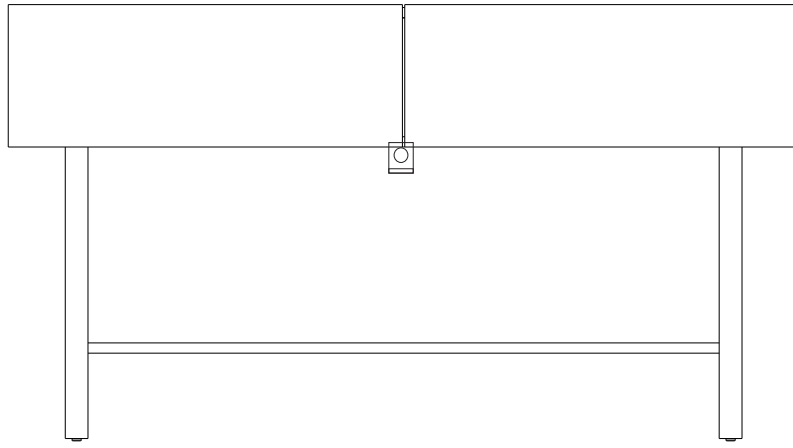

PART-1

PART-2

PART-3

PART-4

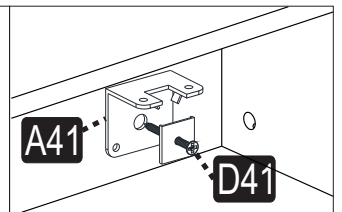
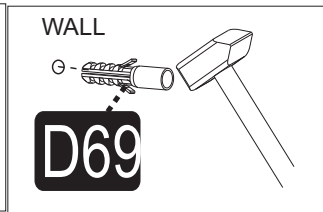
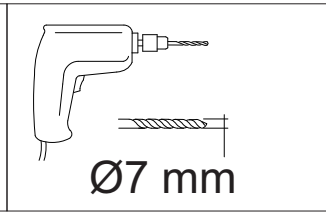
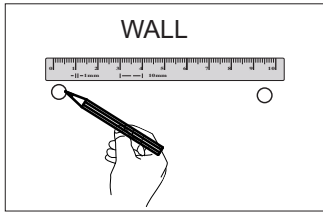

PART-5

PART-6

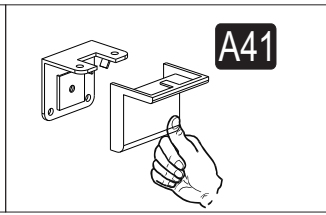
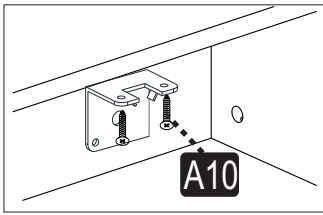

9

