

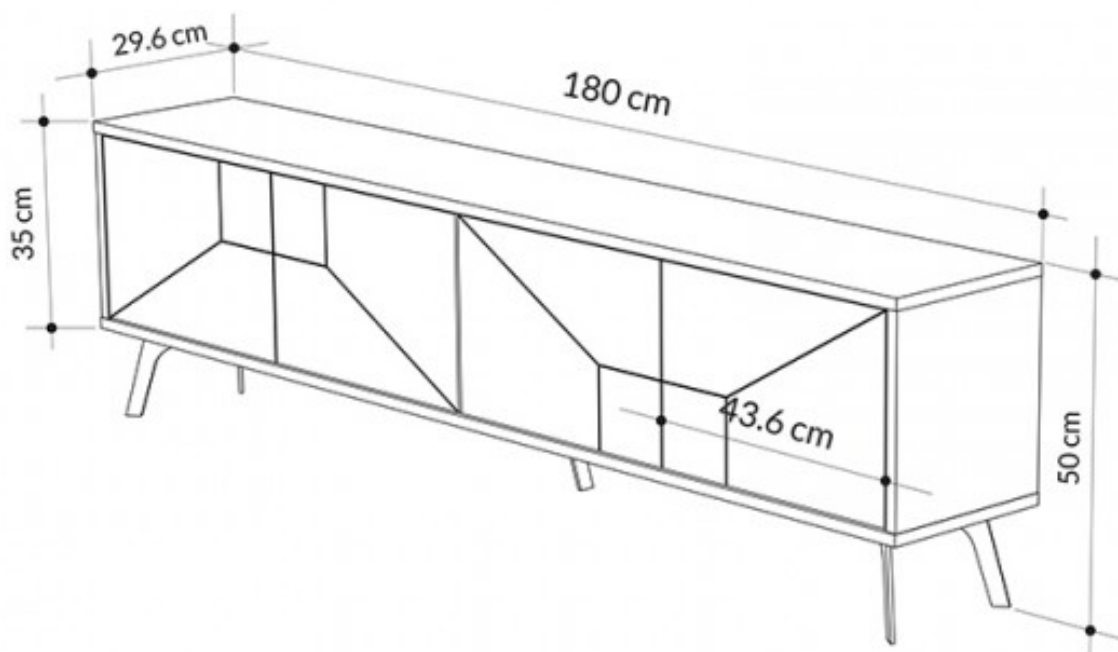

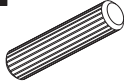







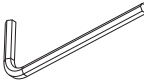

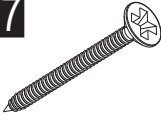

i GP037-0009,4

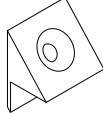
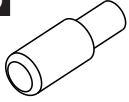

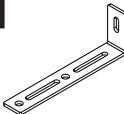
A04  14x	A06  28x	A12  1x	A13  14x	A16  2x
A17  2x	A18  110x	A22  14x	A23  14x	A25  22x
A48  24x	A69  15x	A87  2x	B15  15x	Z72  x4
Z98  1x	C32  8x	C33  4x	C34  12x	A27.a  6x
				A27.b  6x

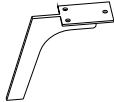

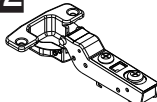
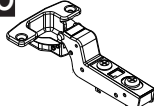
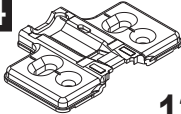
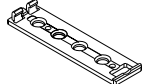
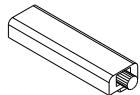
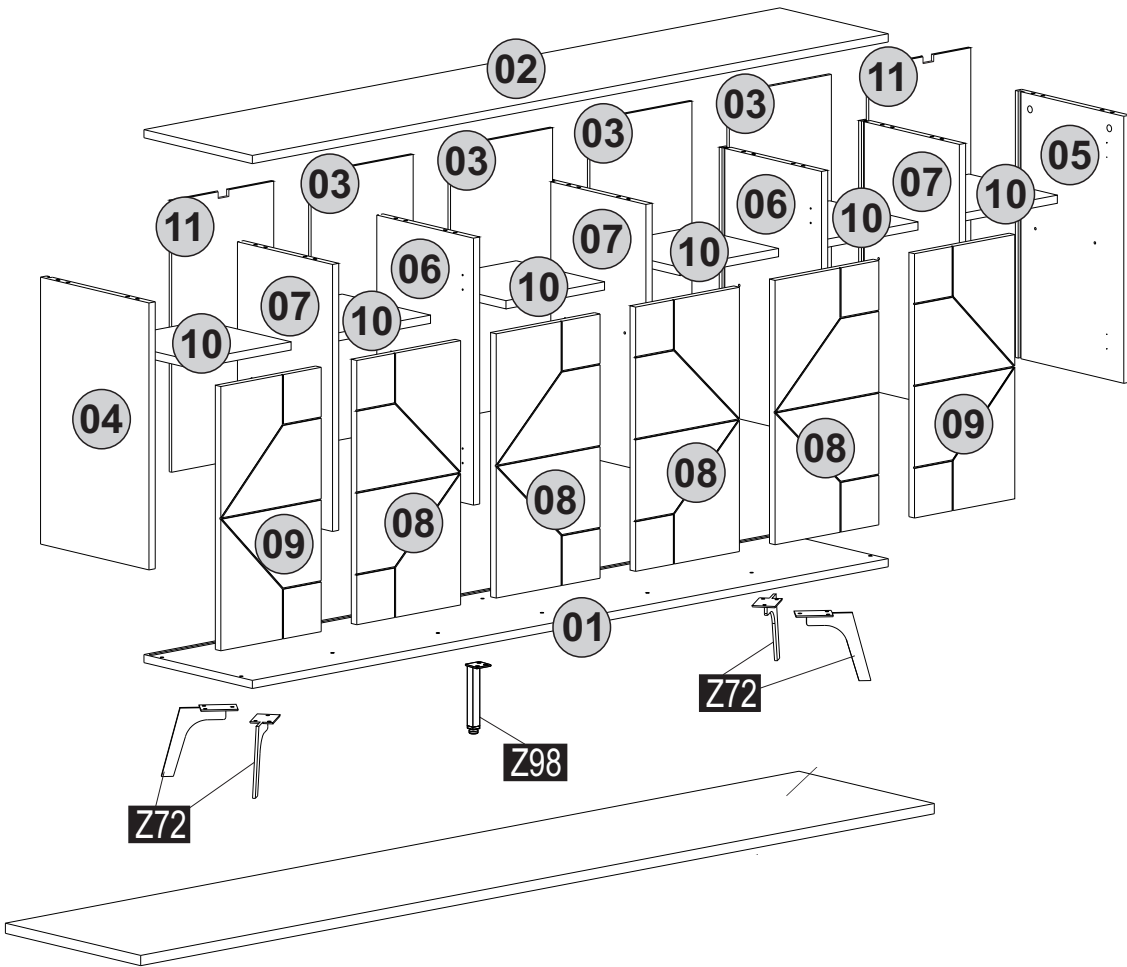
1

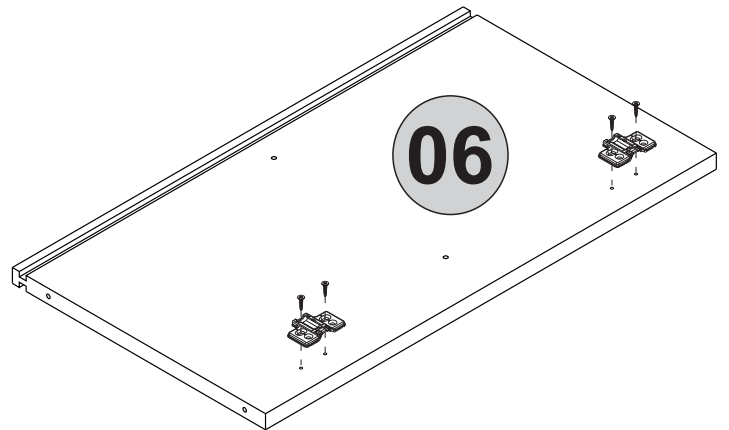
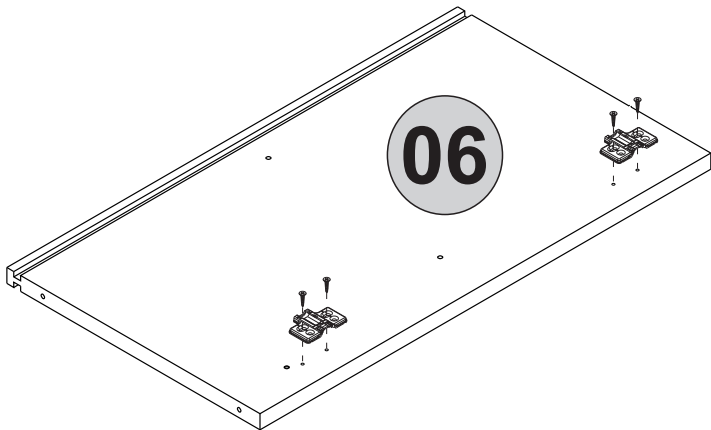
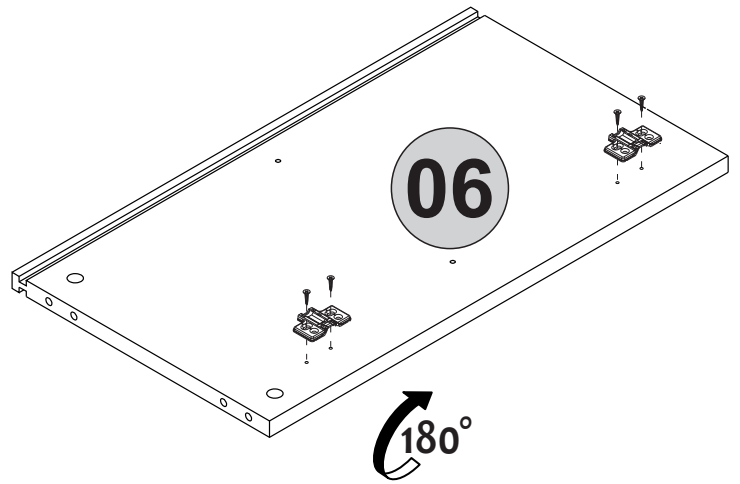
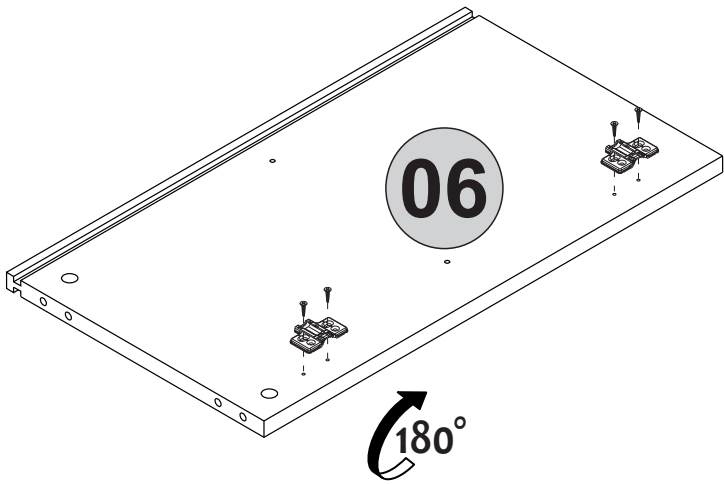
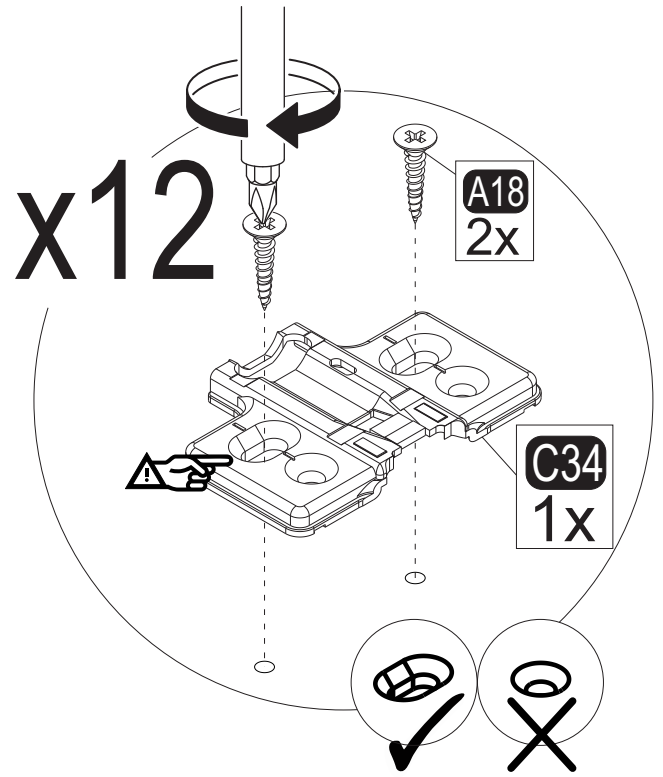
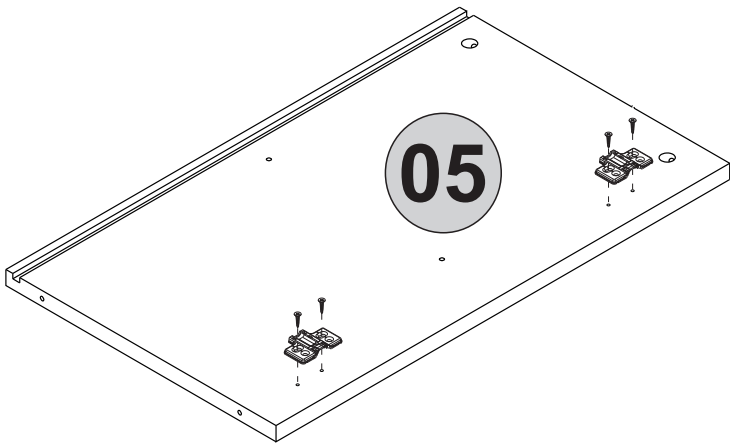
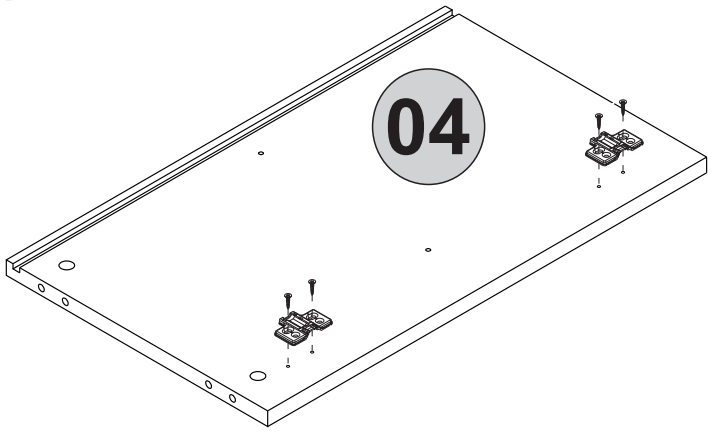

2

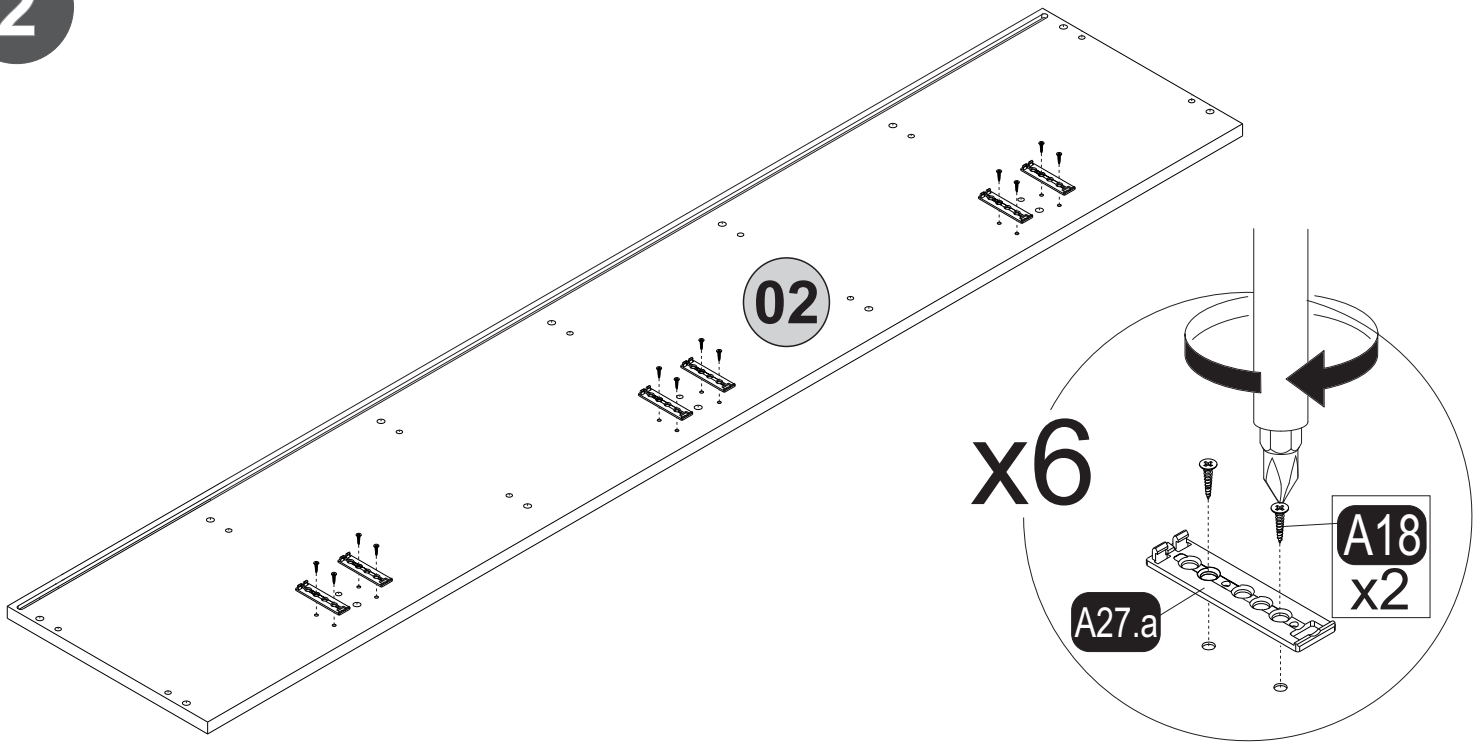

3

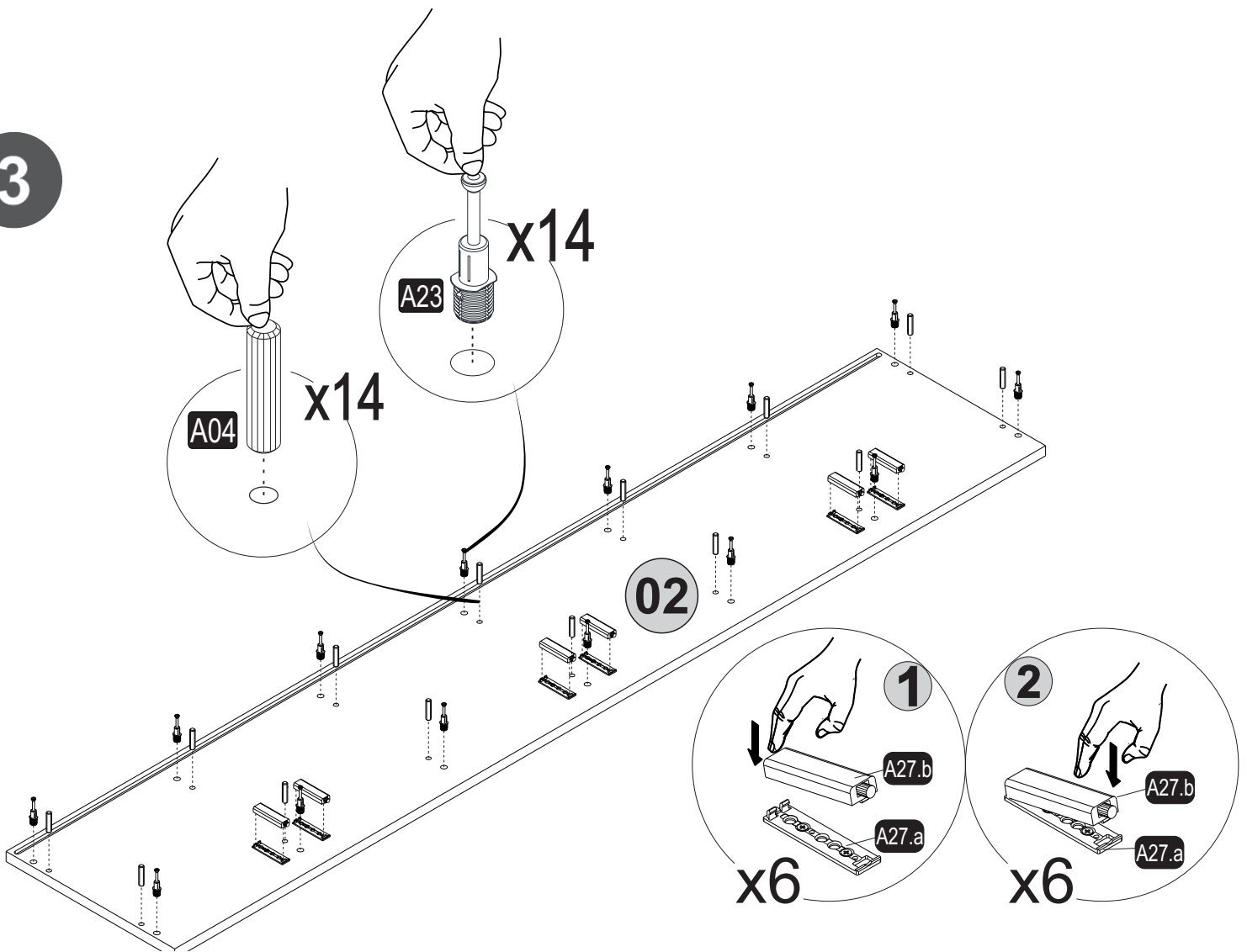

4

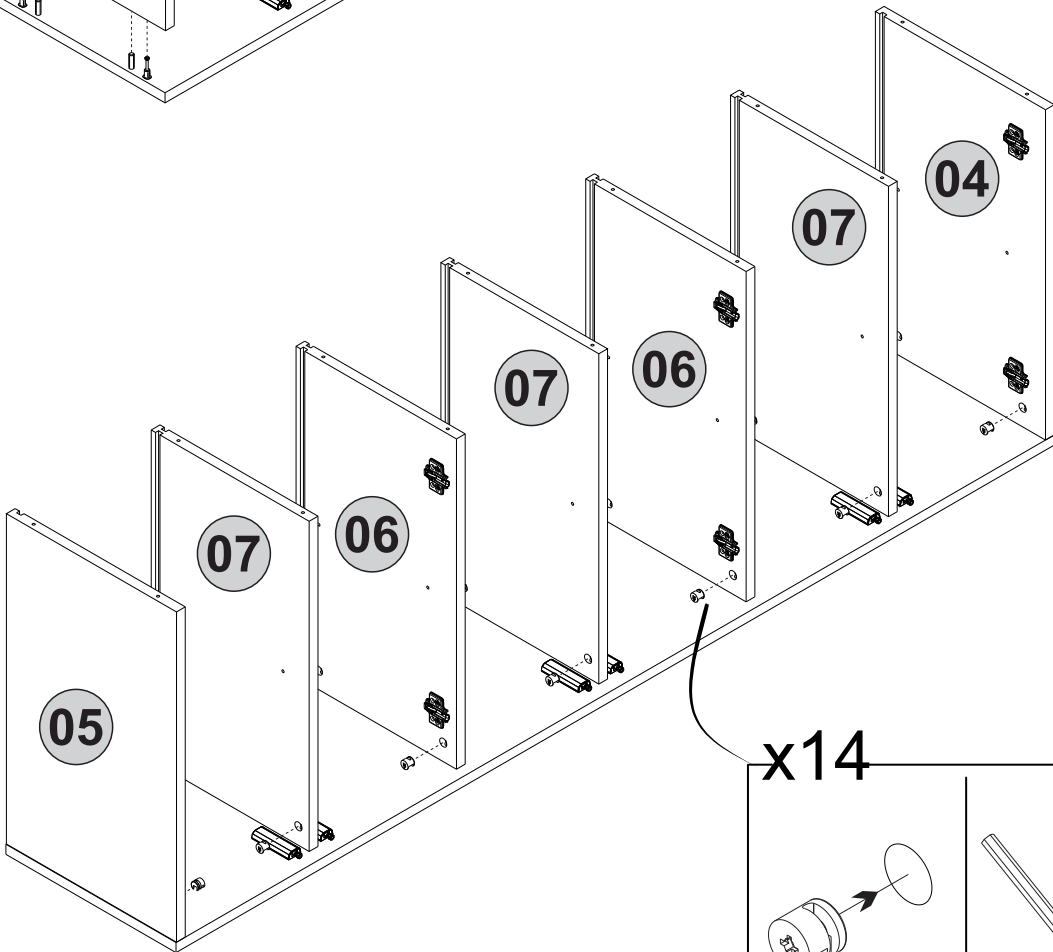
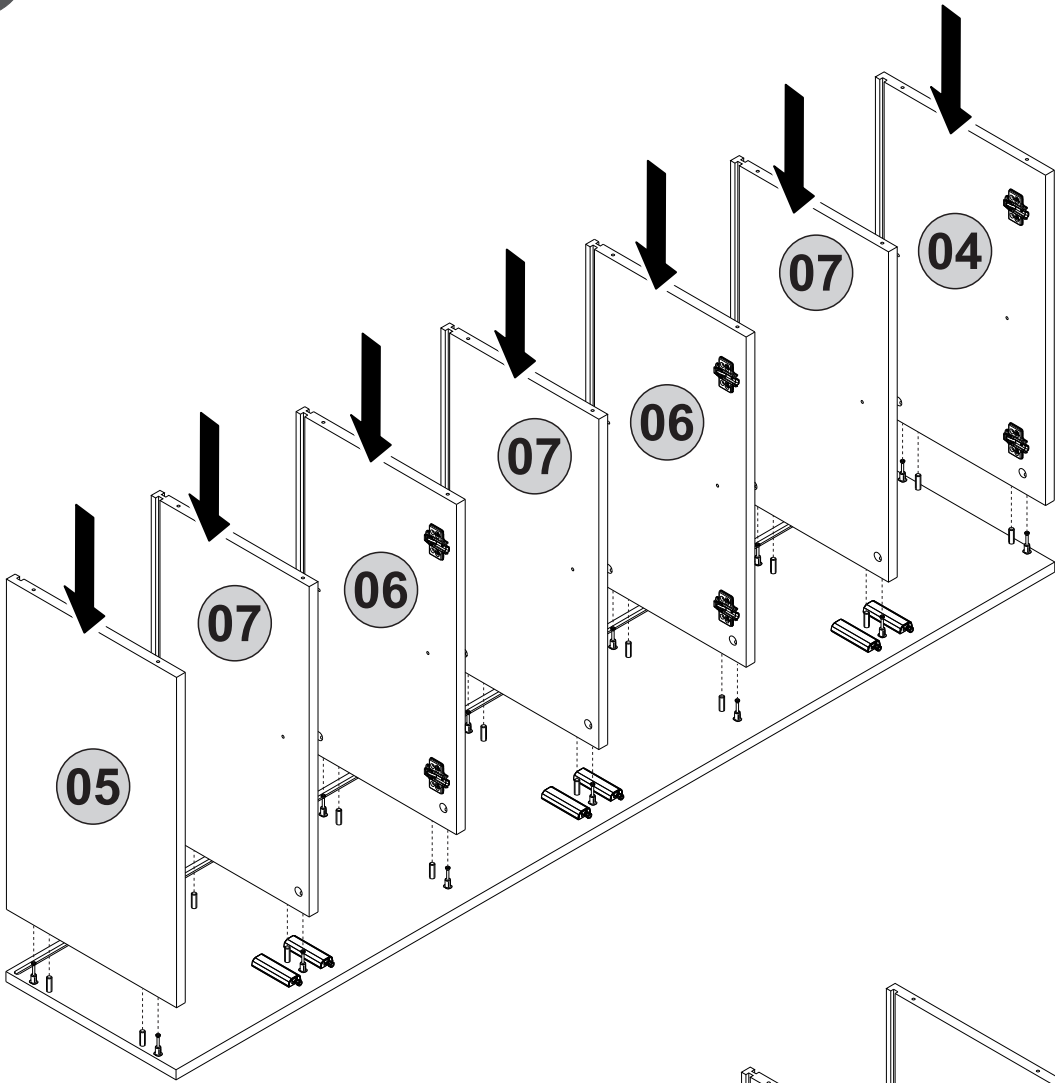

x14

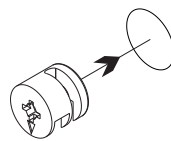

A22 1x

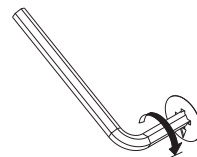

A12 1x

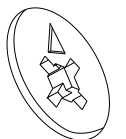

5

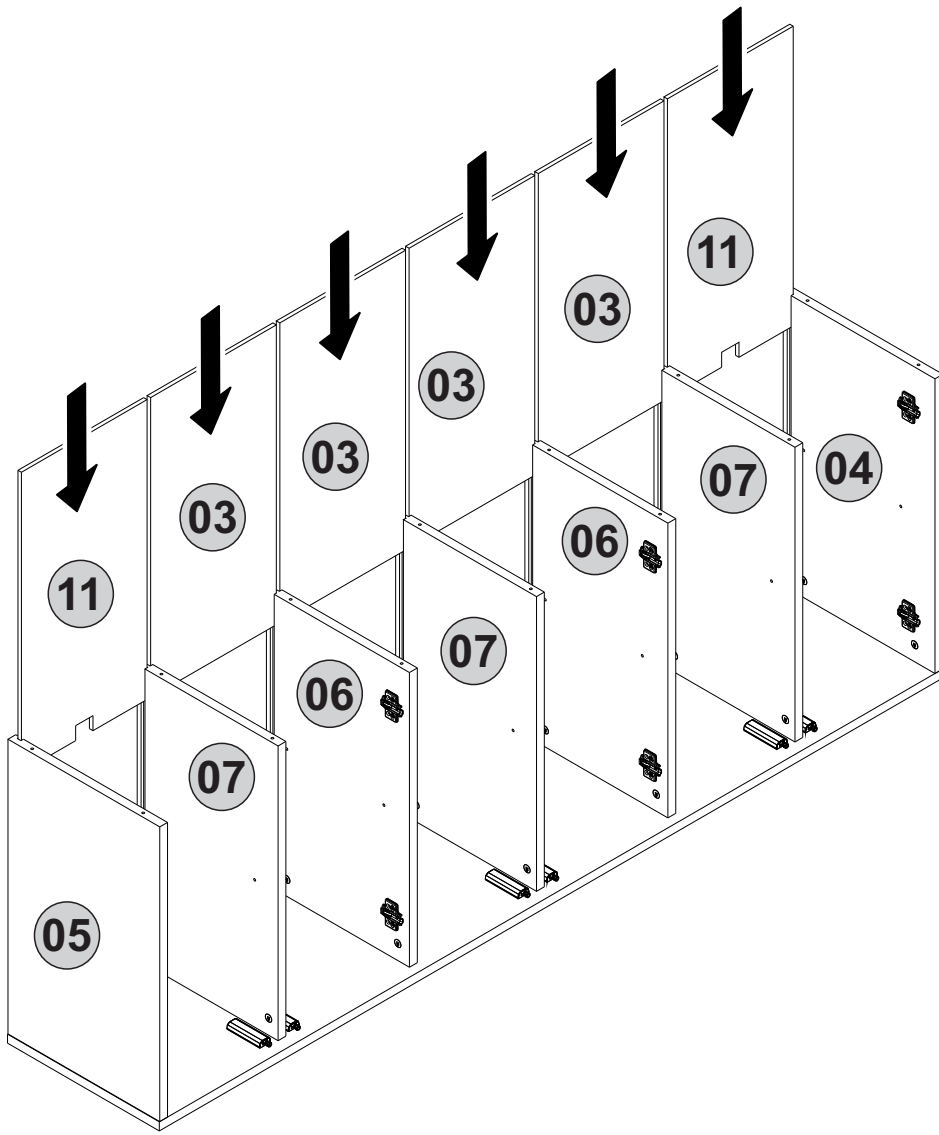

6

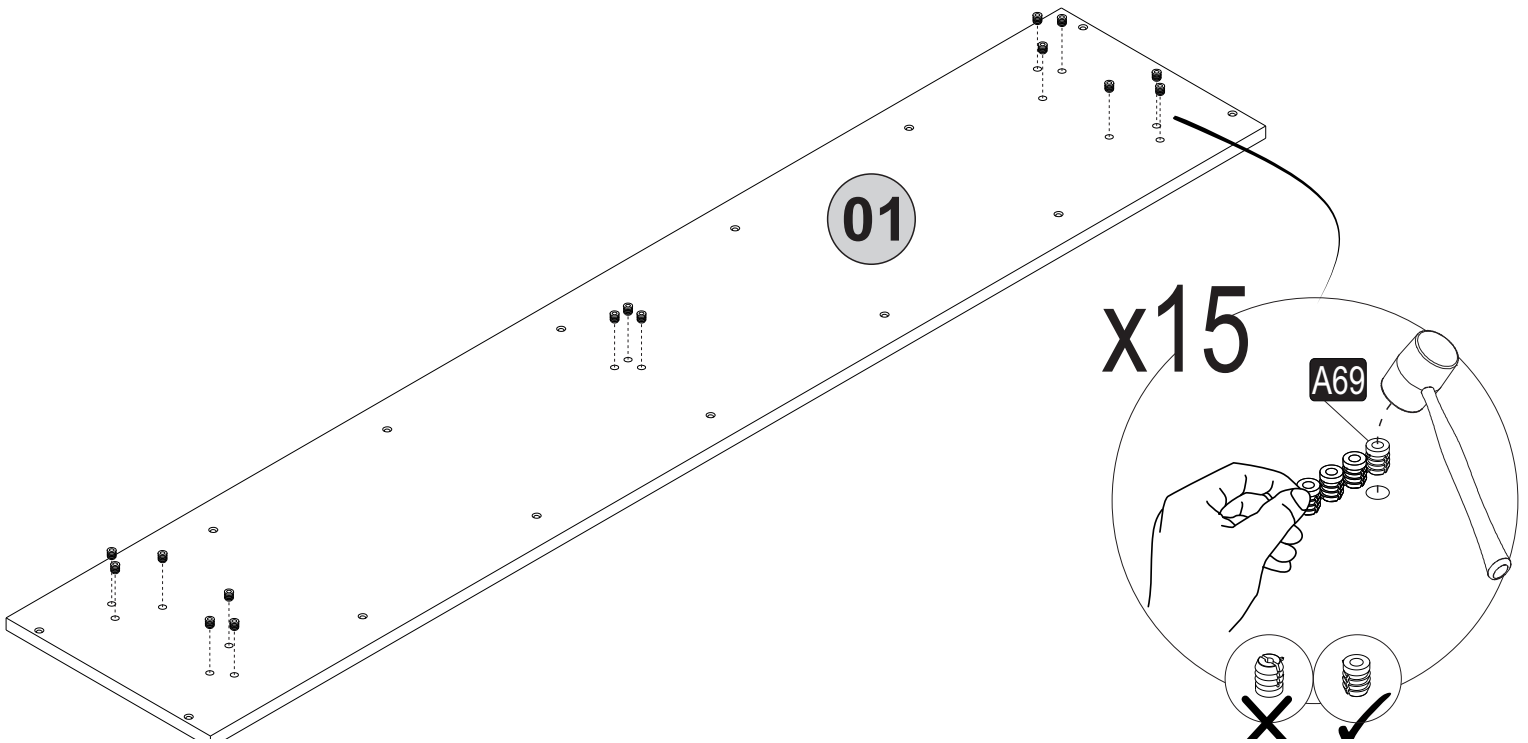

7

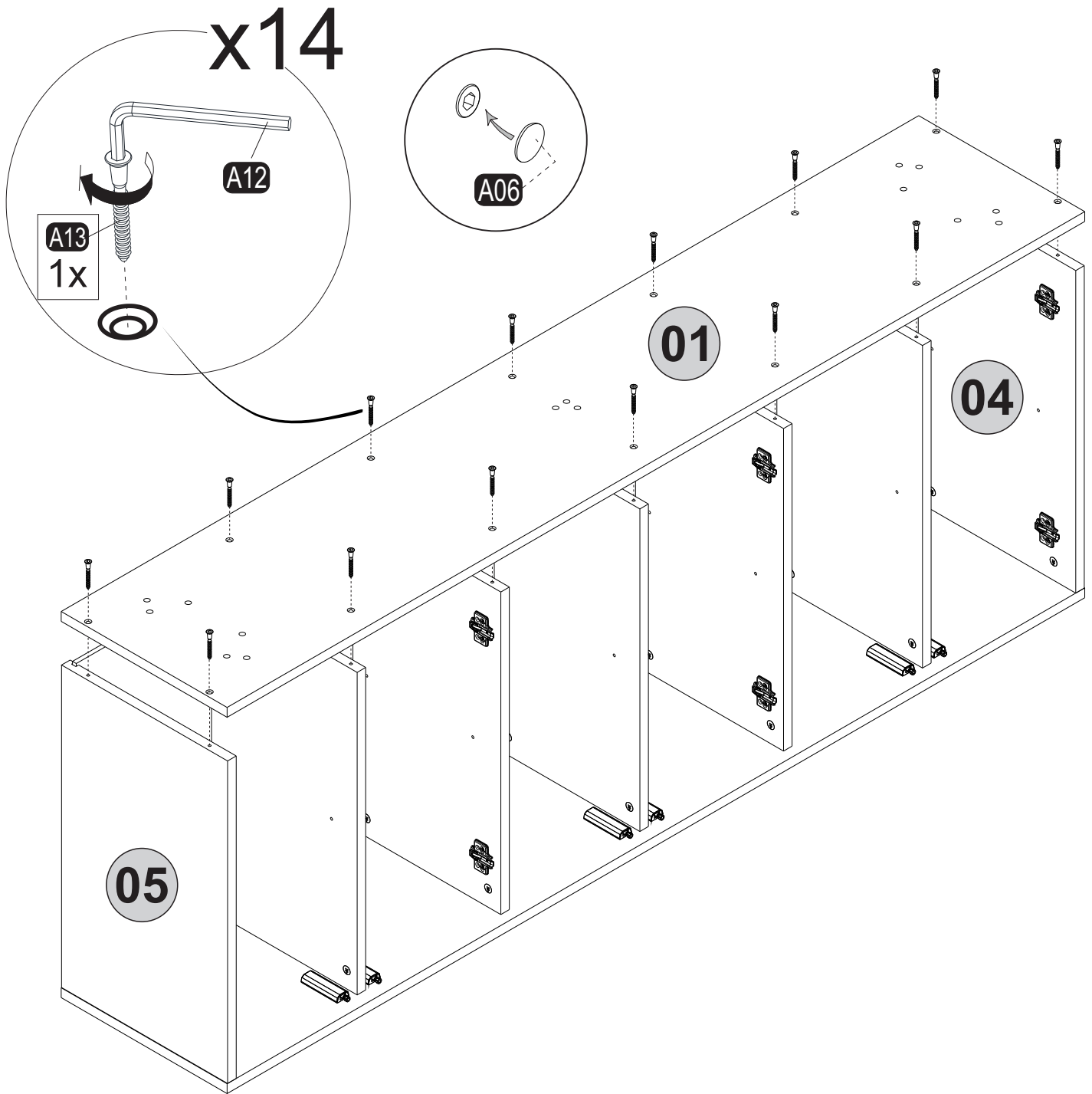

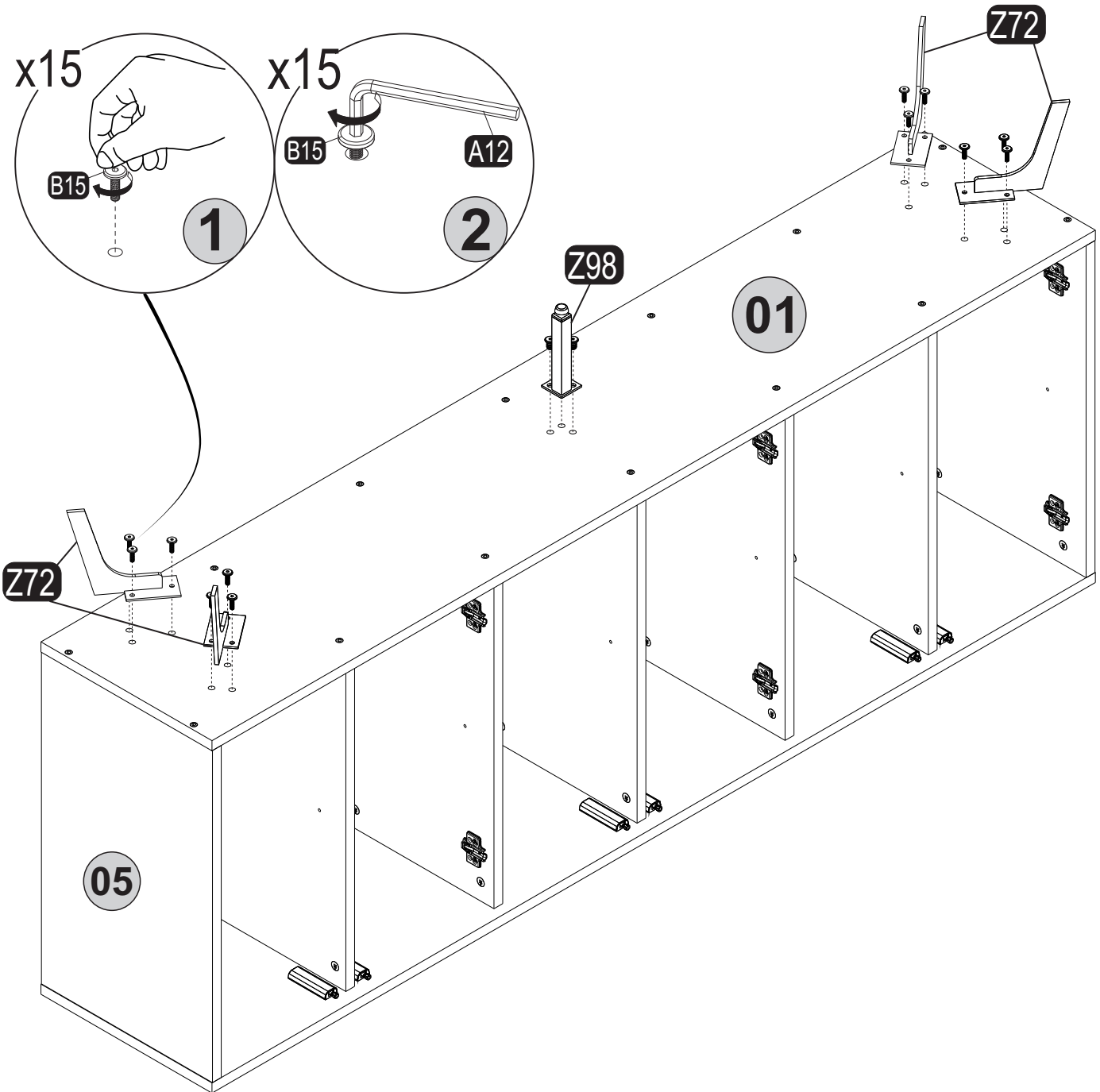
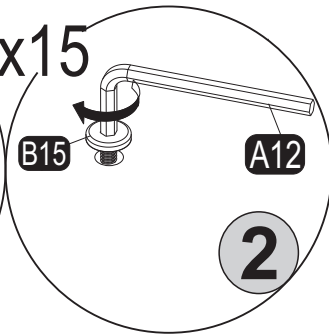
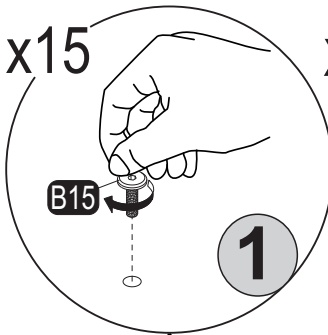

9

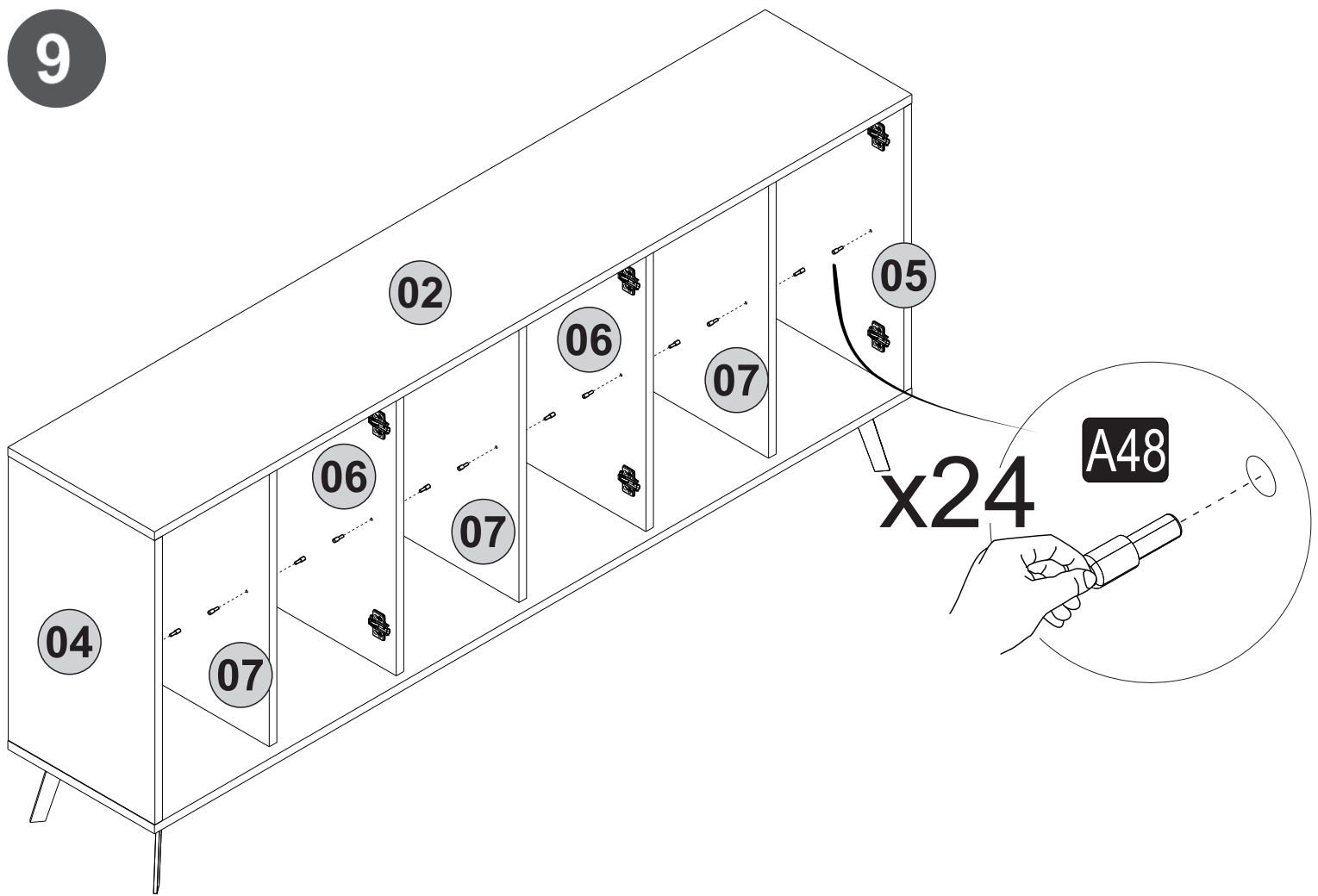

10

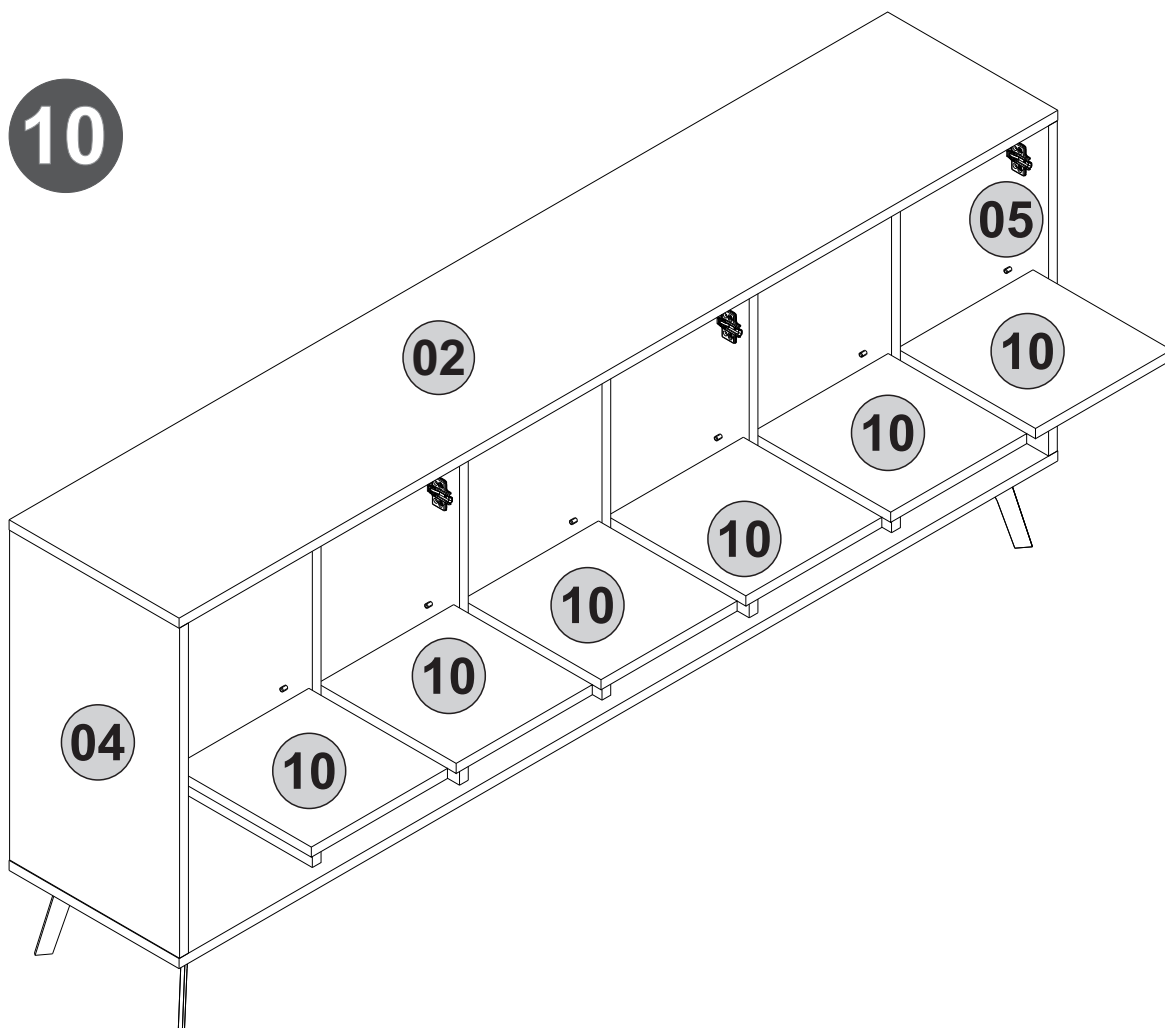

11 x4

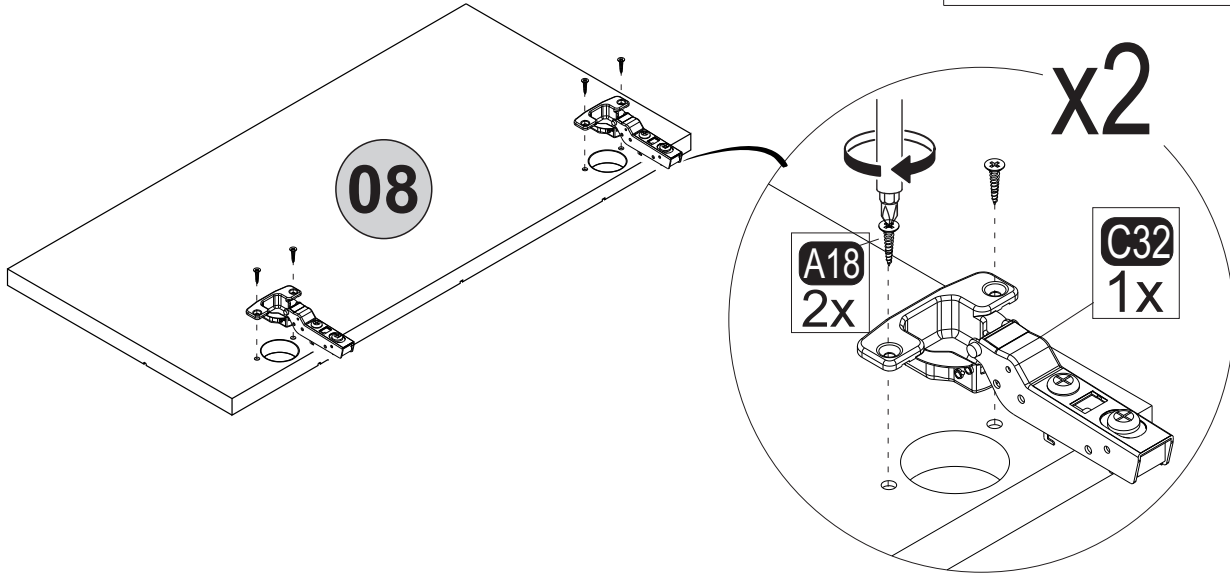
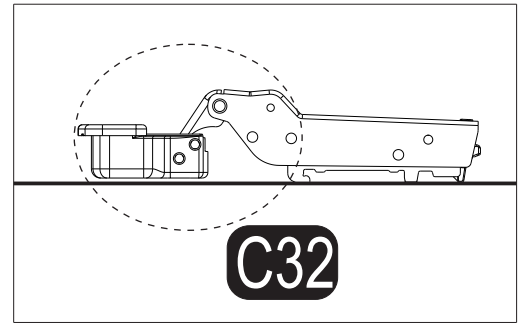

12 x2

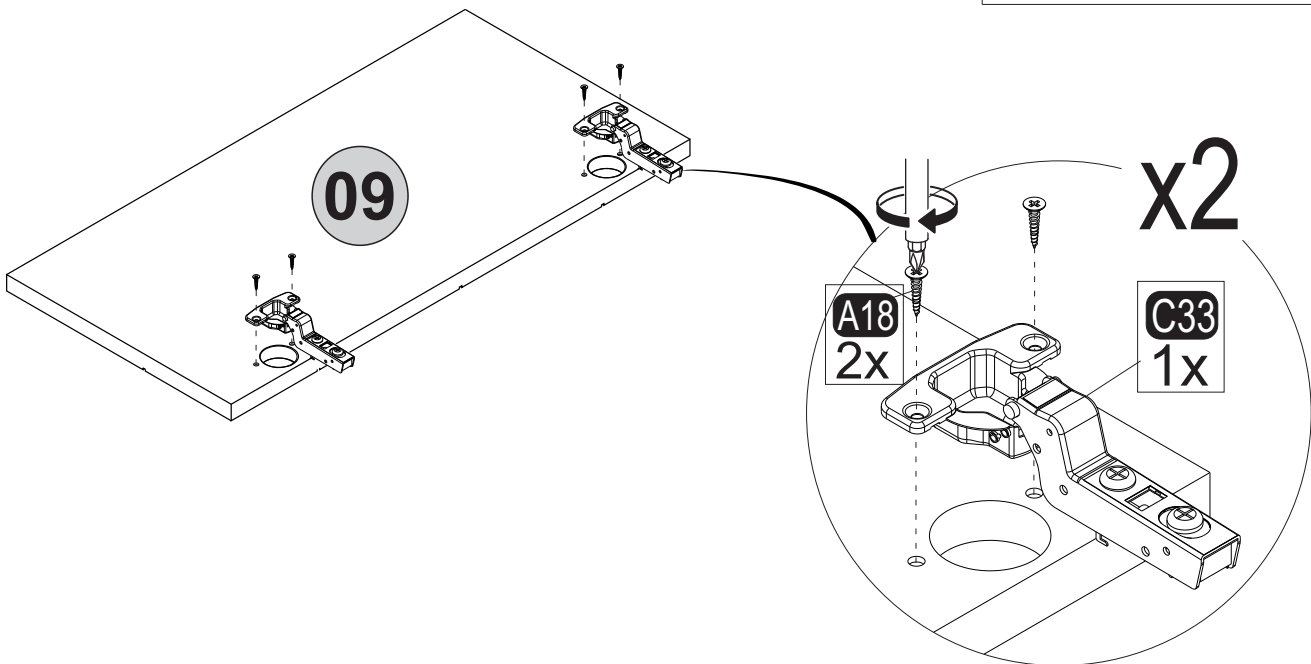
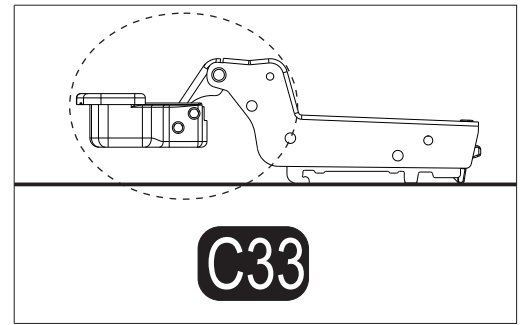

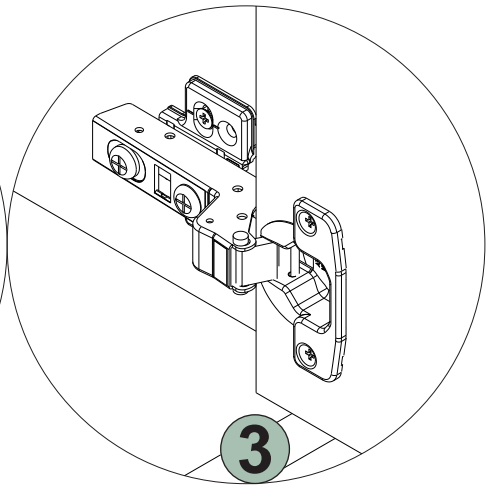
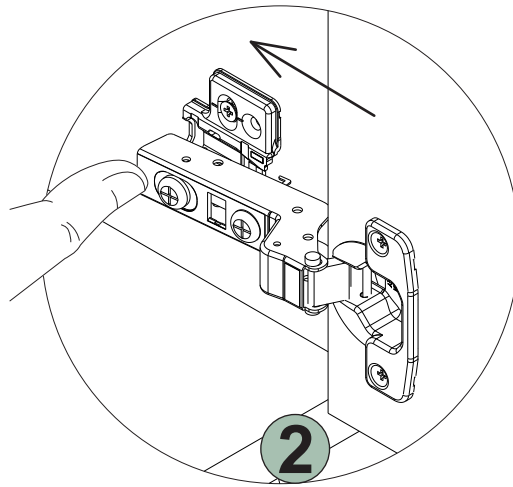
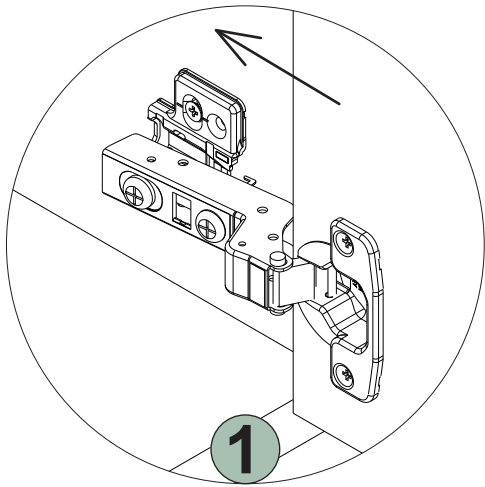
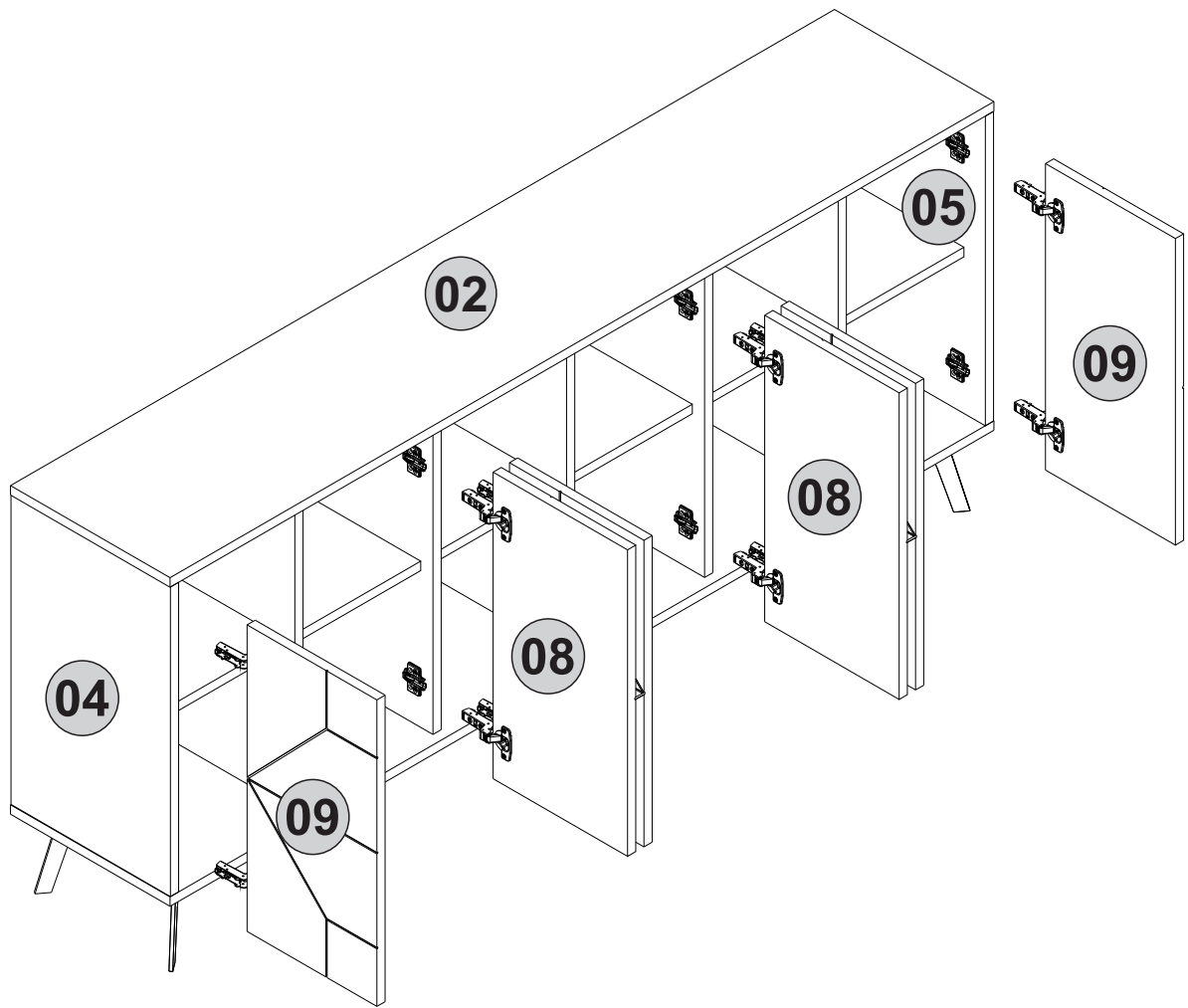

14

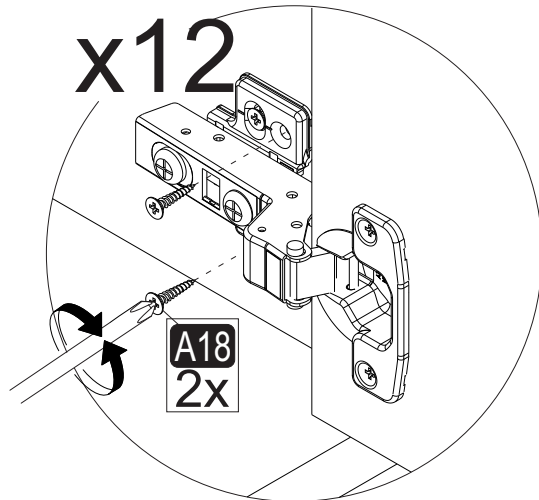
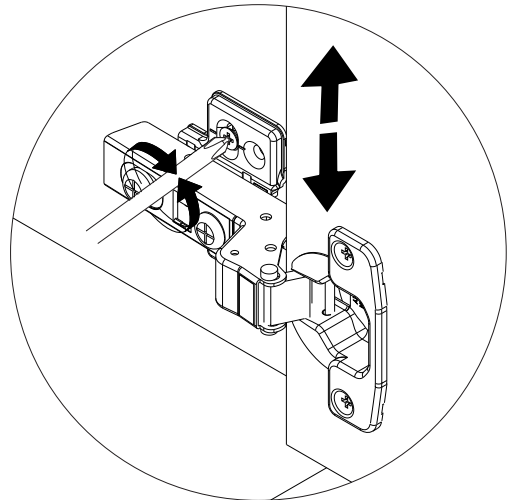
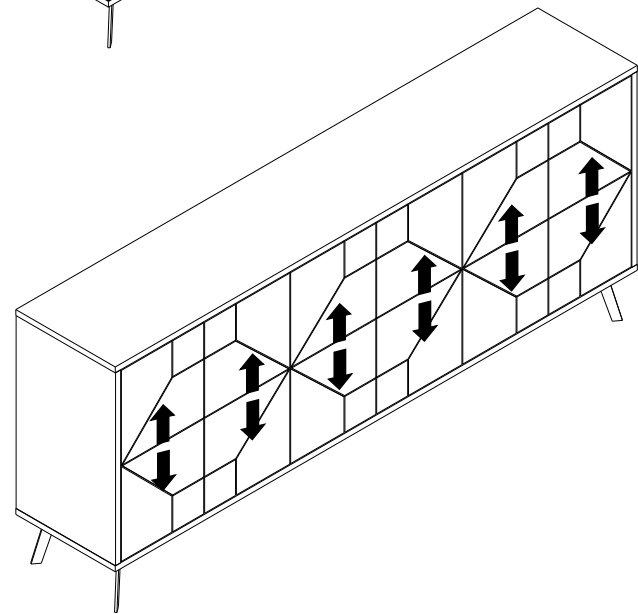
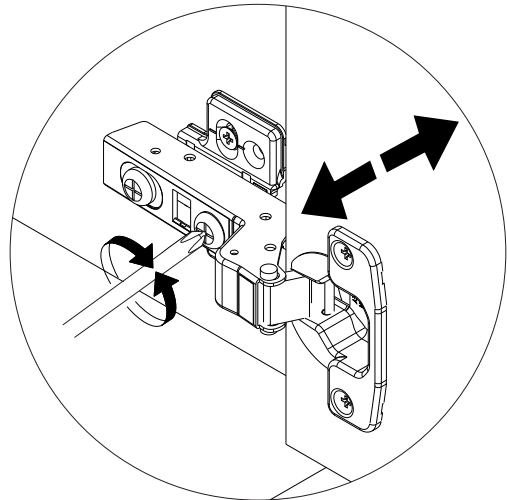
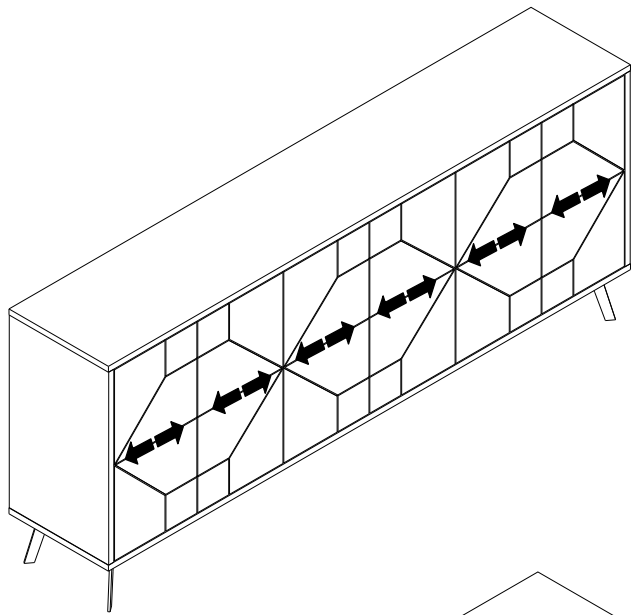
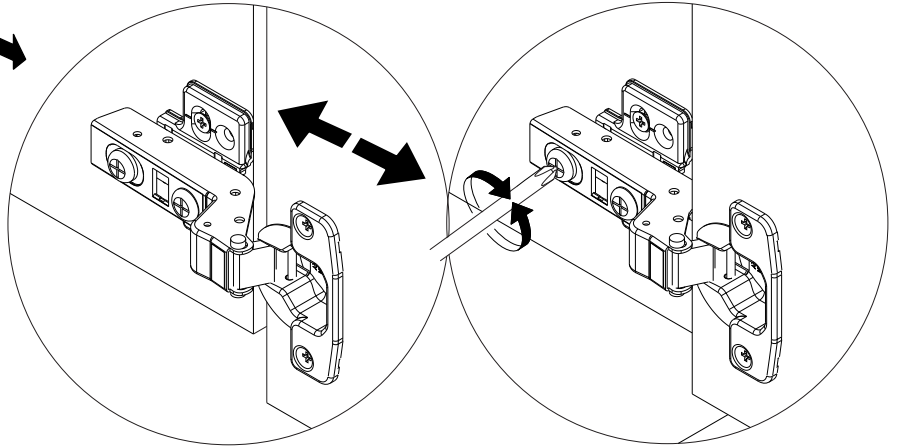
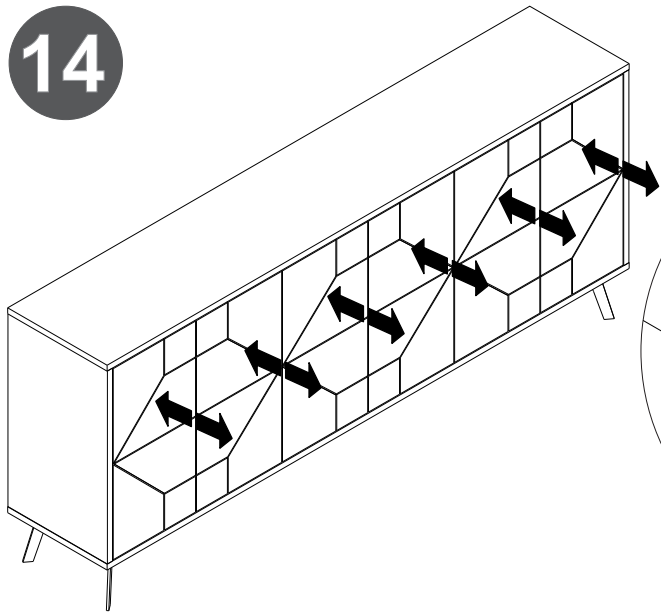

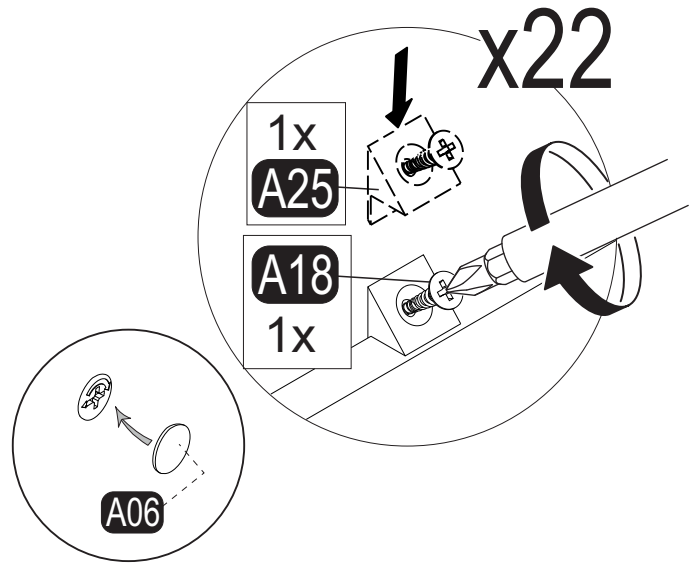
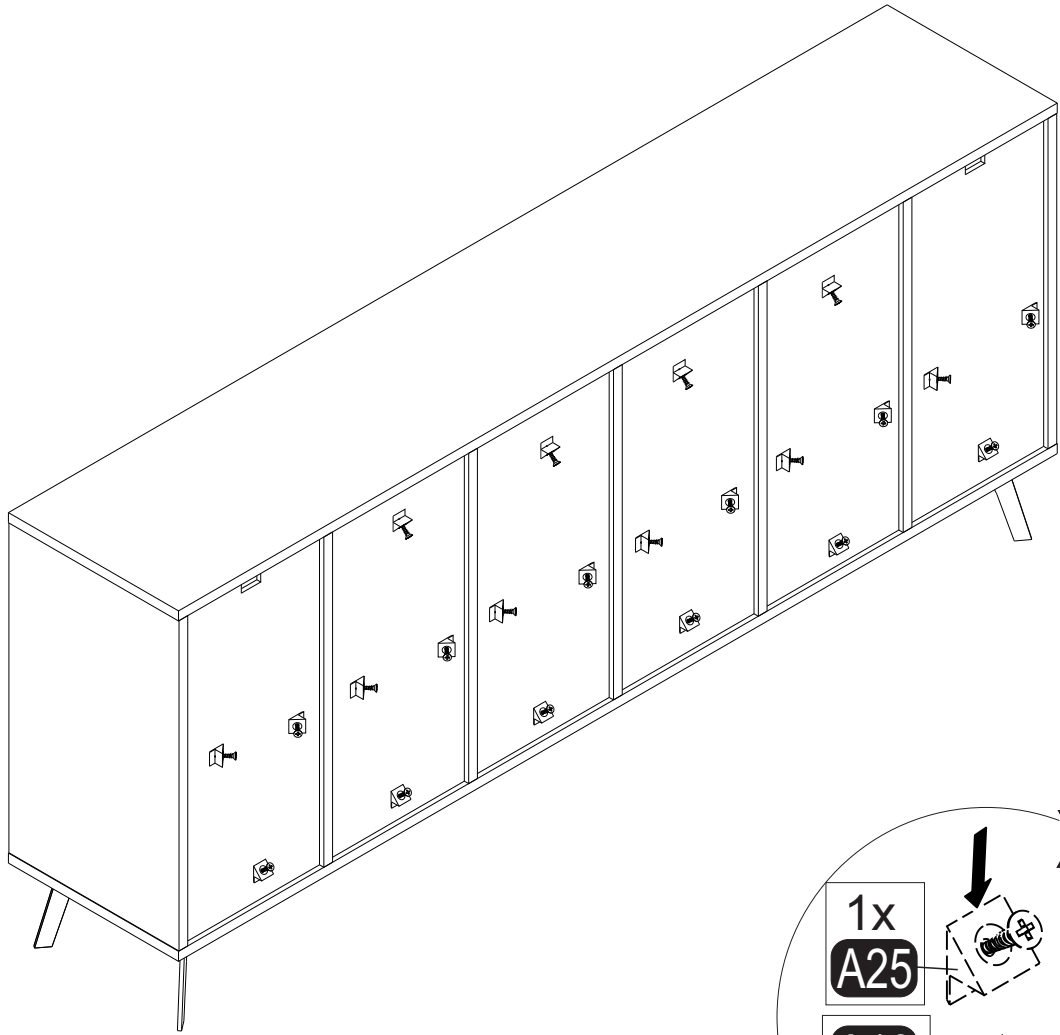

16

