

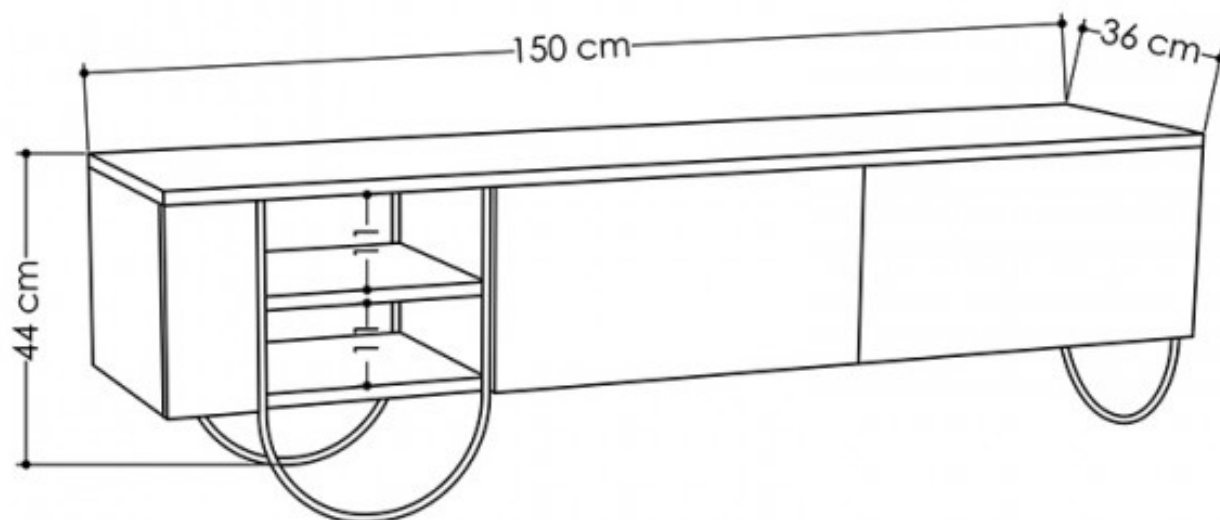







i GP037-0035,1

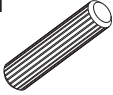

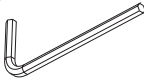
A22 Minifix k18  24x	A23 Minifix M10  24x	A04 Ø8  28x	A13 50mm  4x	A12 Allen  1x
A06 18mm  C1-28x	C17 DmF(S)  2x	C14 Dm(S)  2x	C20 Mtk(S)  4x	A18 3,5x18  32x
Z53 Shk1  2x	Z07 4x22kv  2x	A67 3,5x30 (Black)  6x	Z33 300x436x12  3x	Z67 DKP  2x

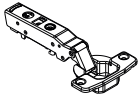
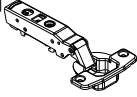
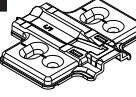
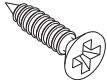

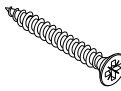
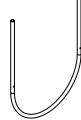
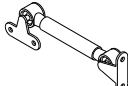
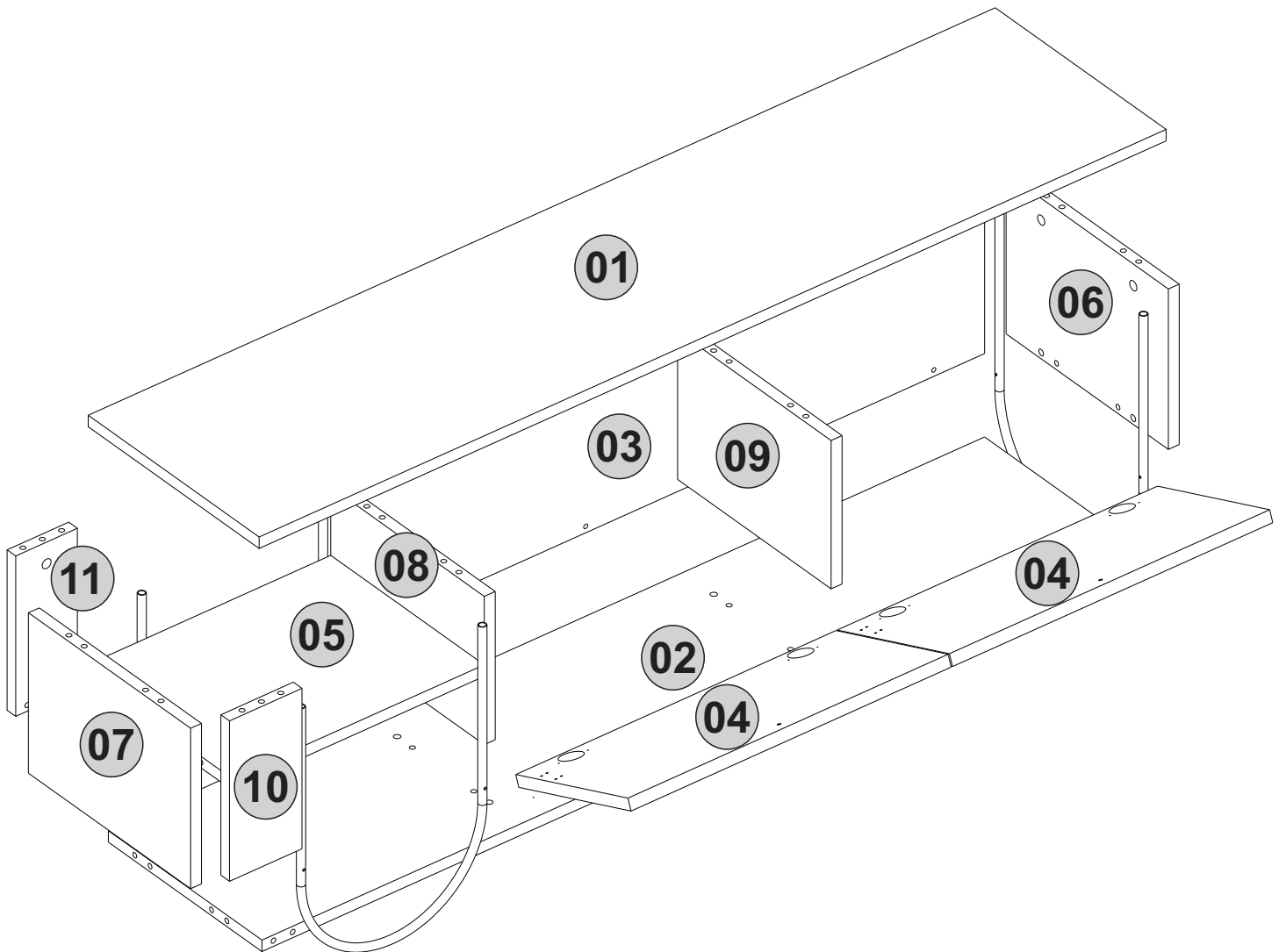
1. step

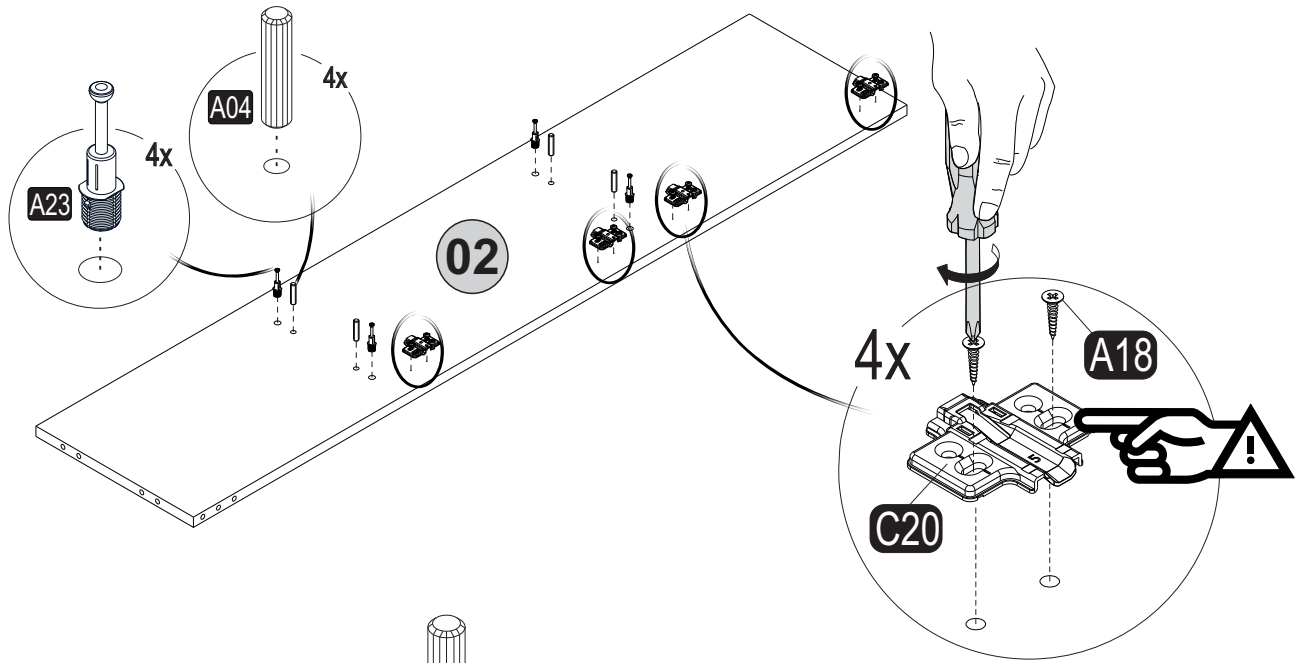

2. step

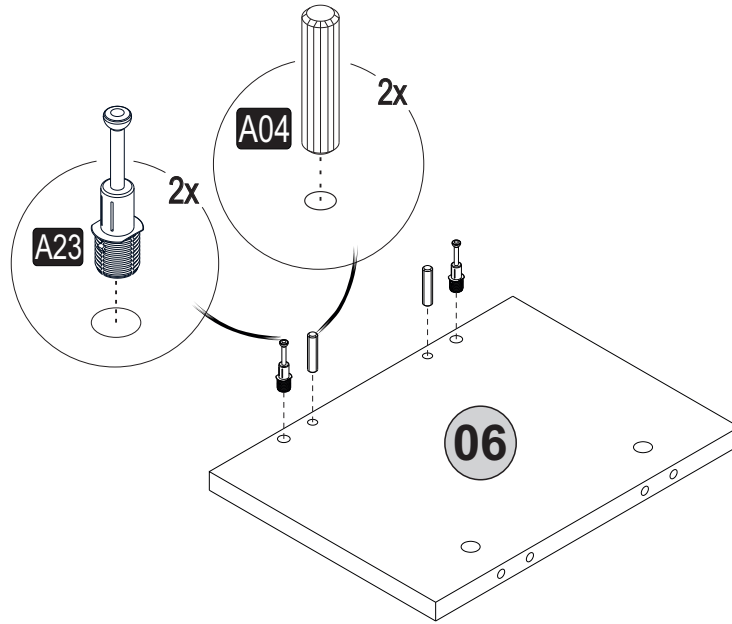

3. step

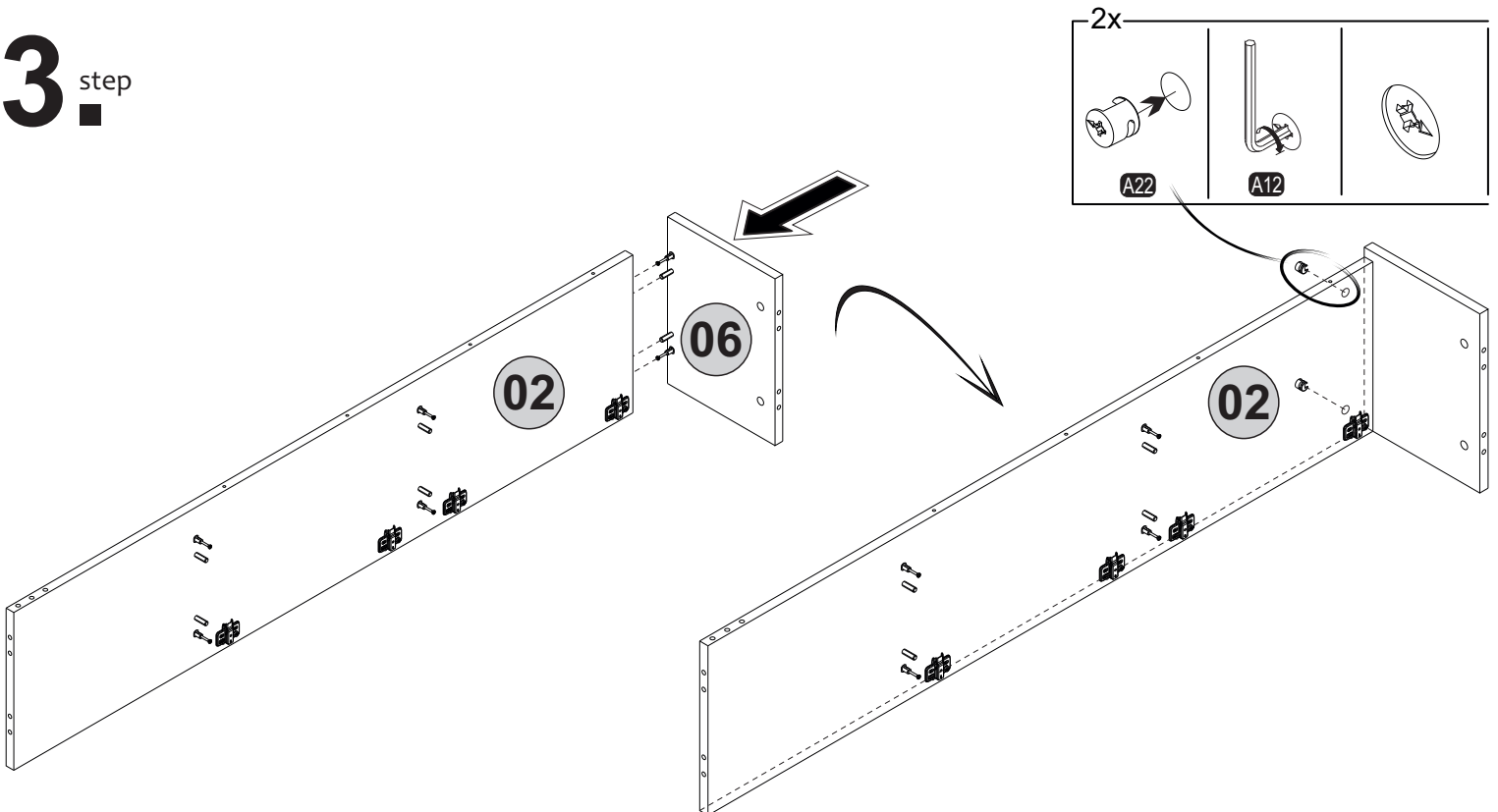

4. step

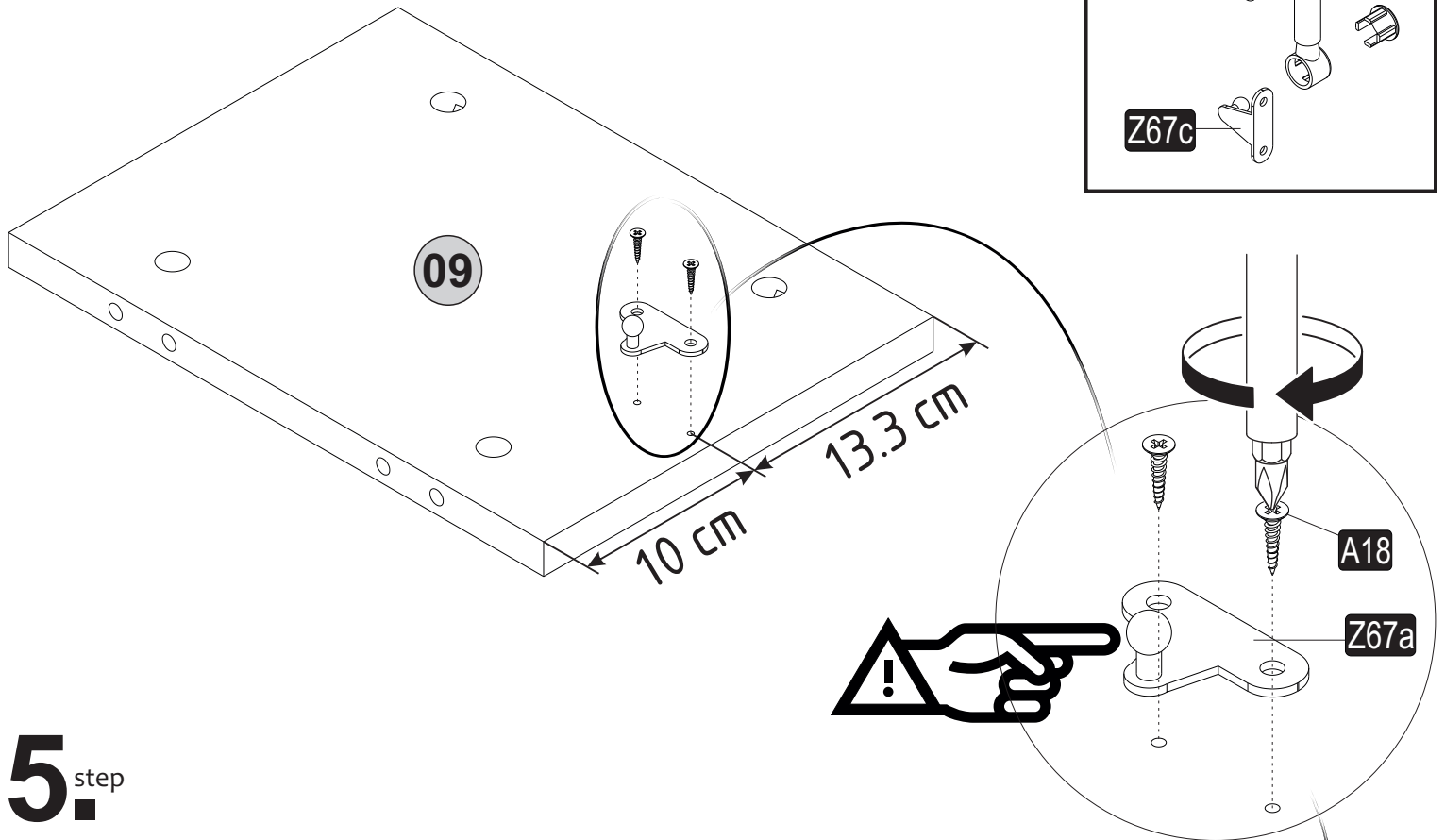

5. step

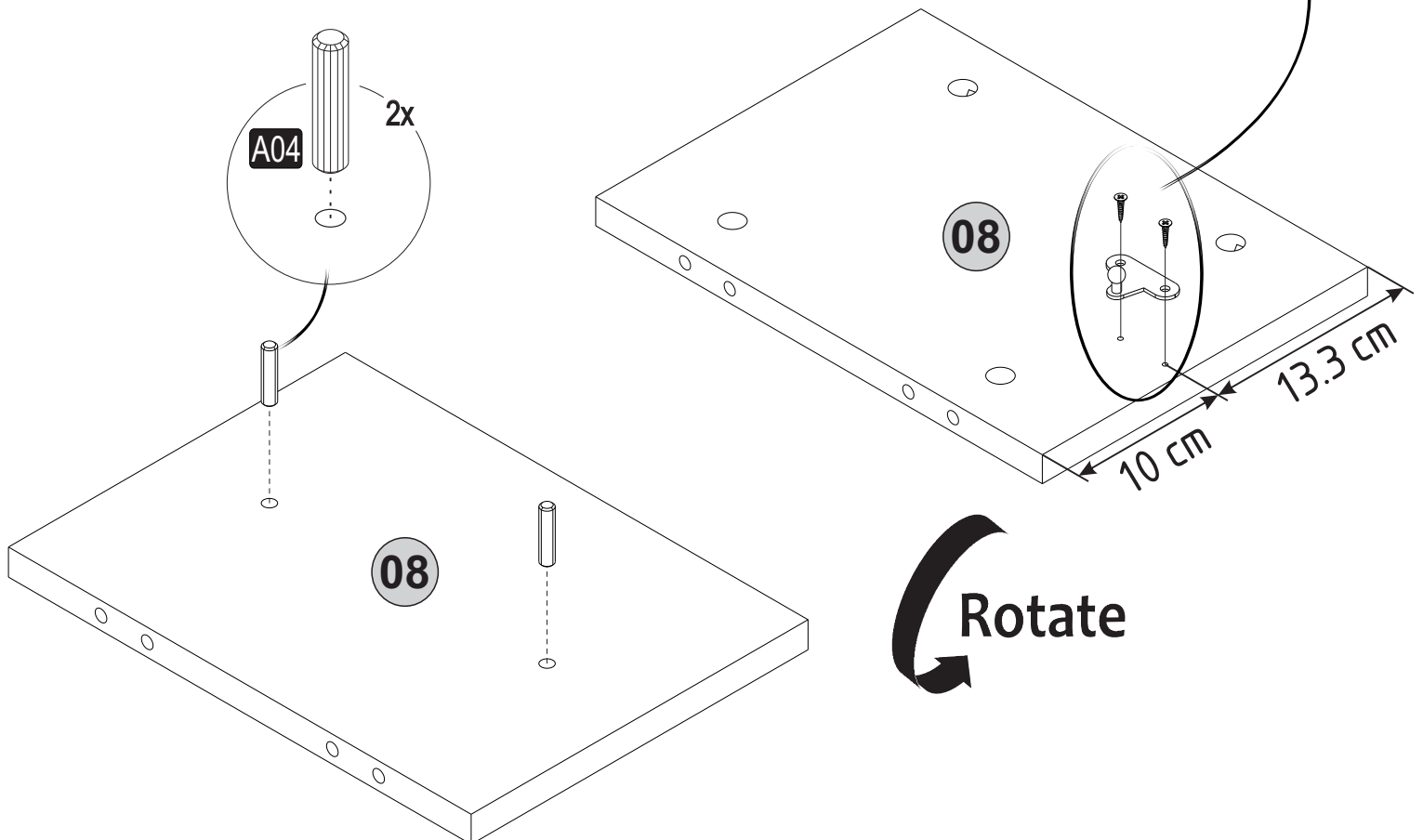

6^{step}

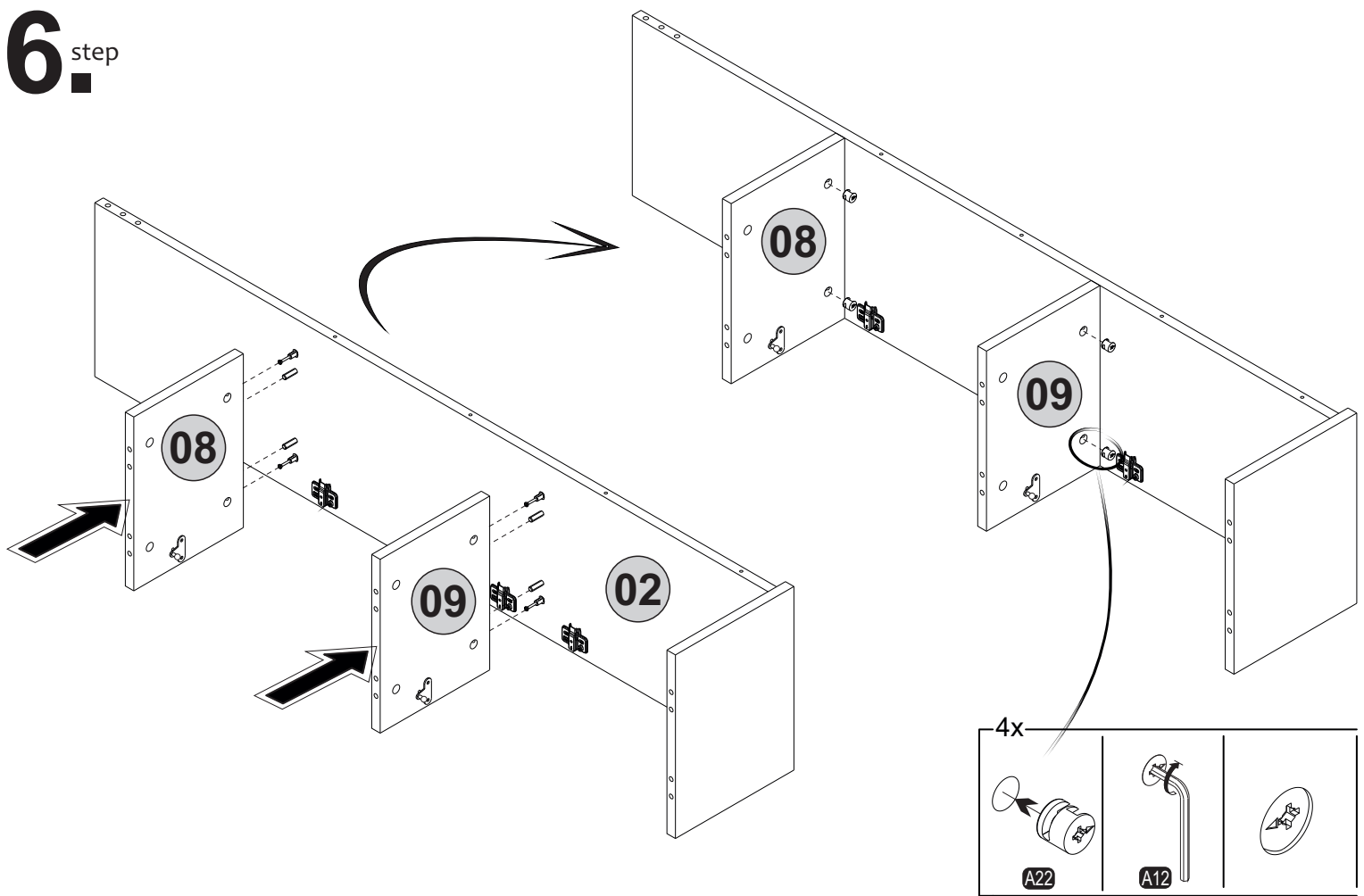

7^{step}

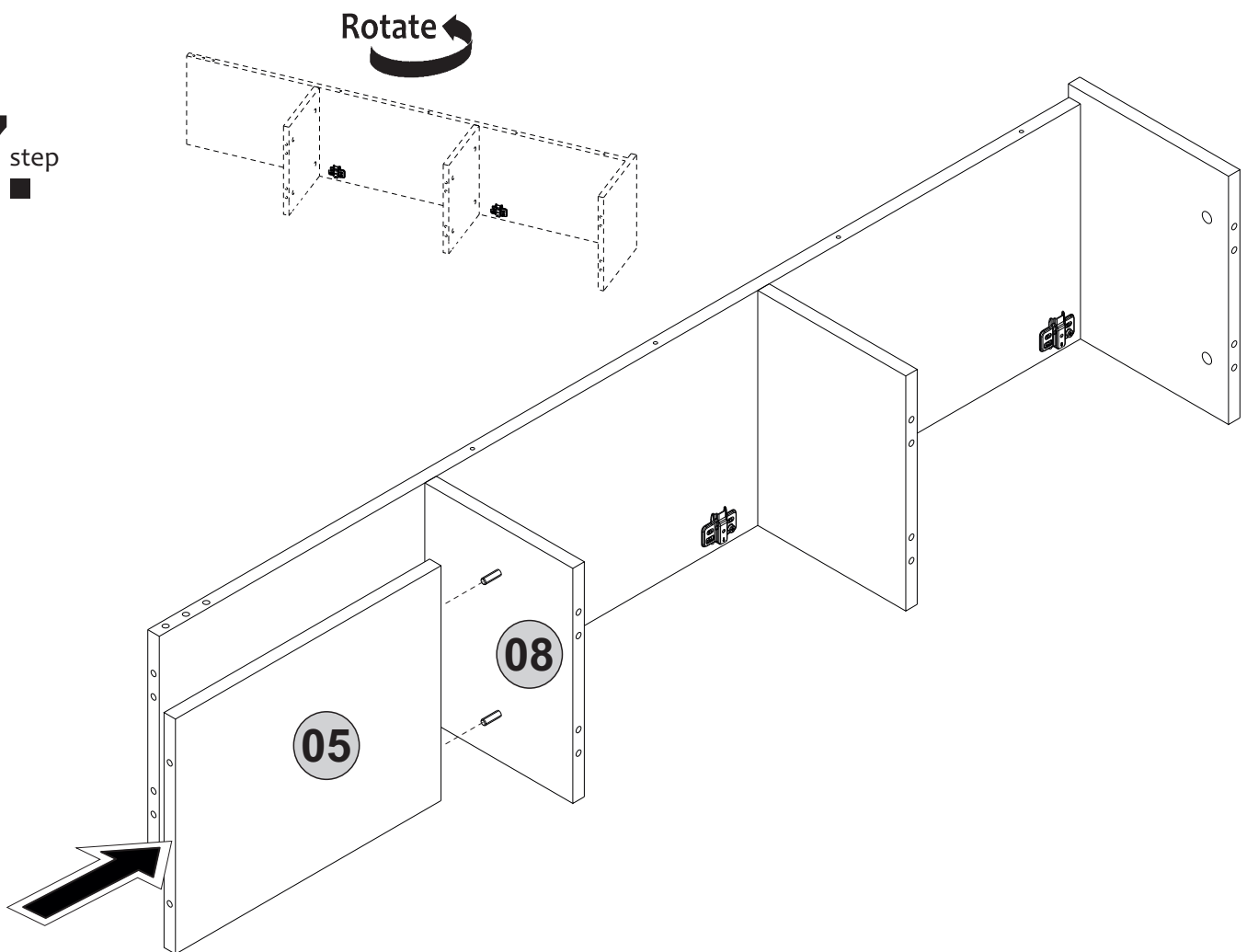

8^{step}

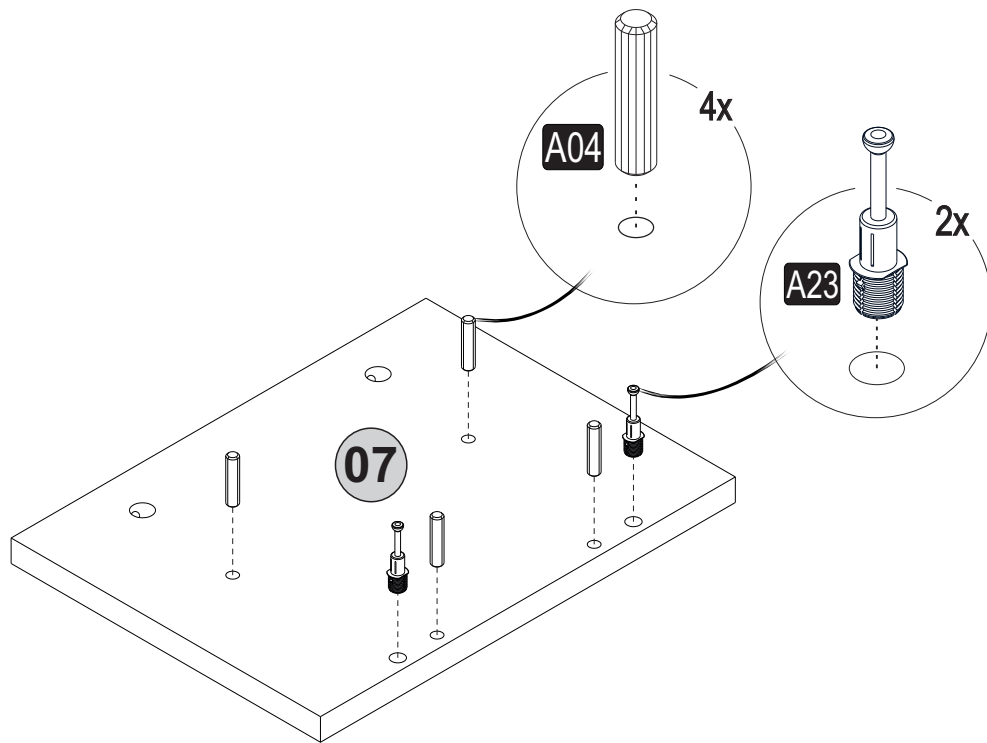

9^{step}

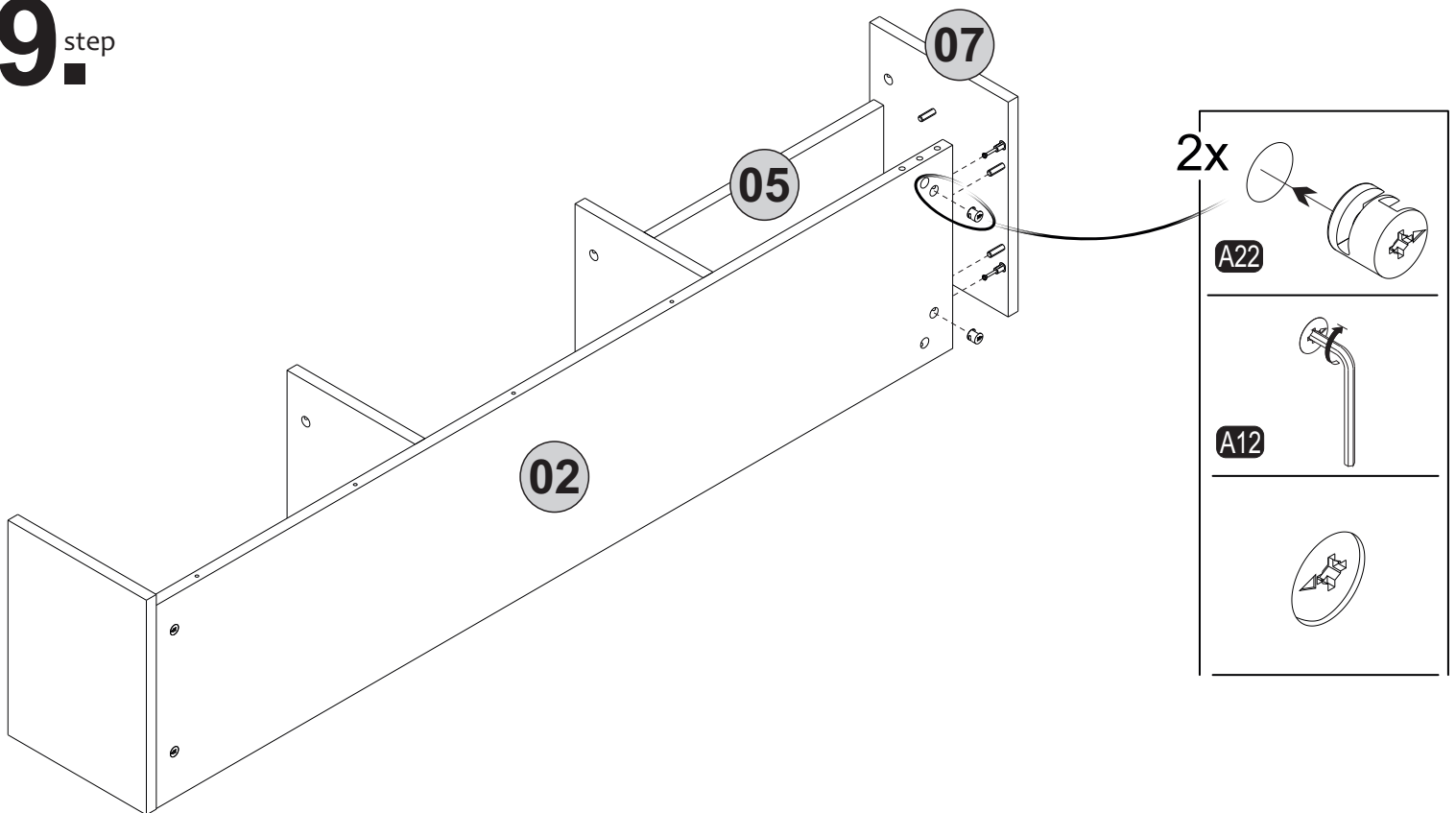

10.^{step}

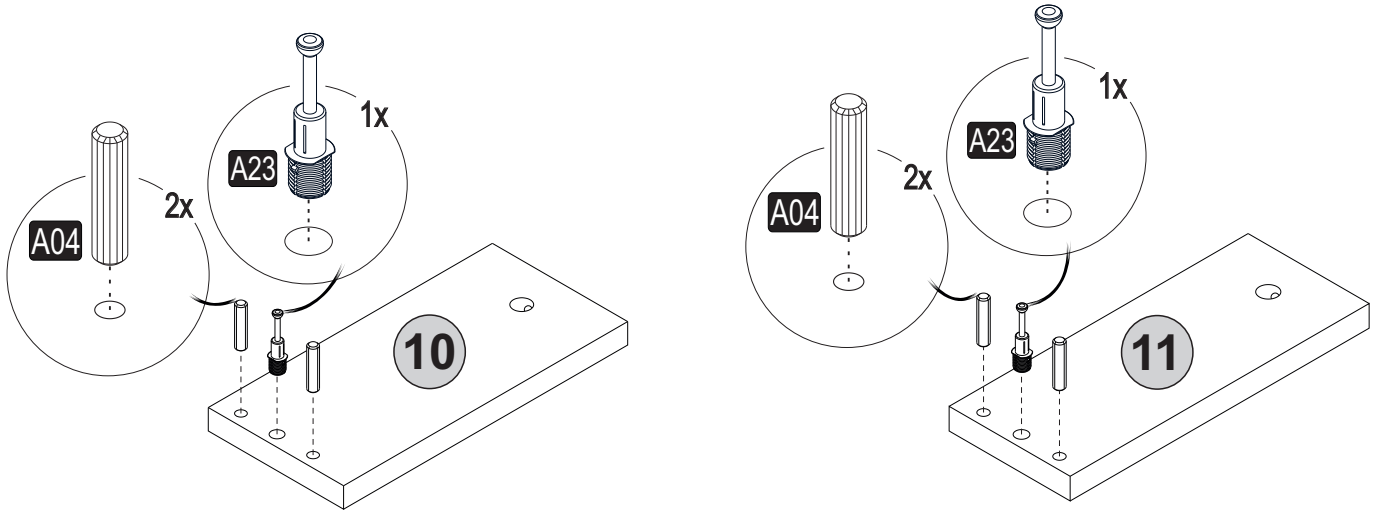

11.^{step}

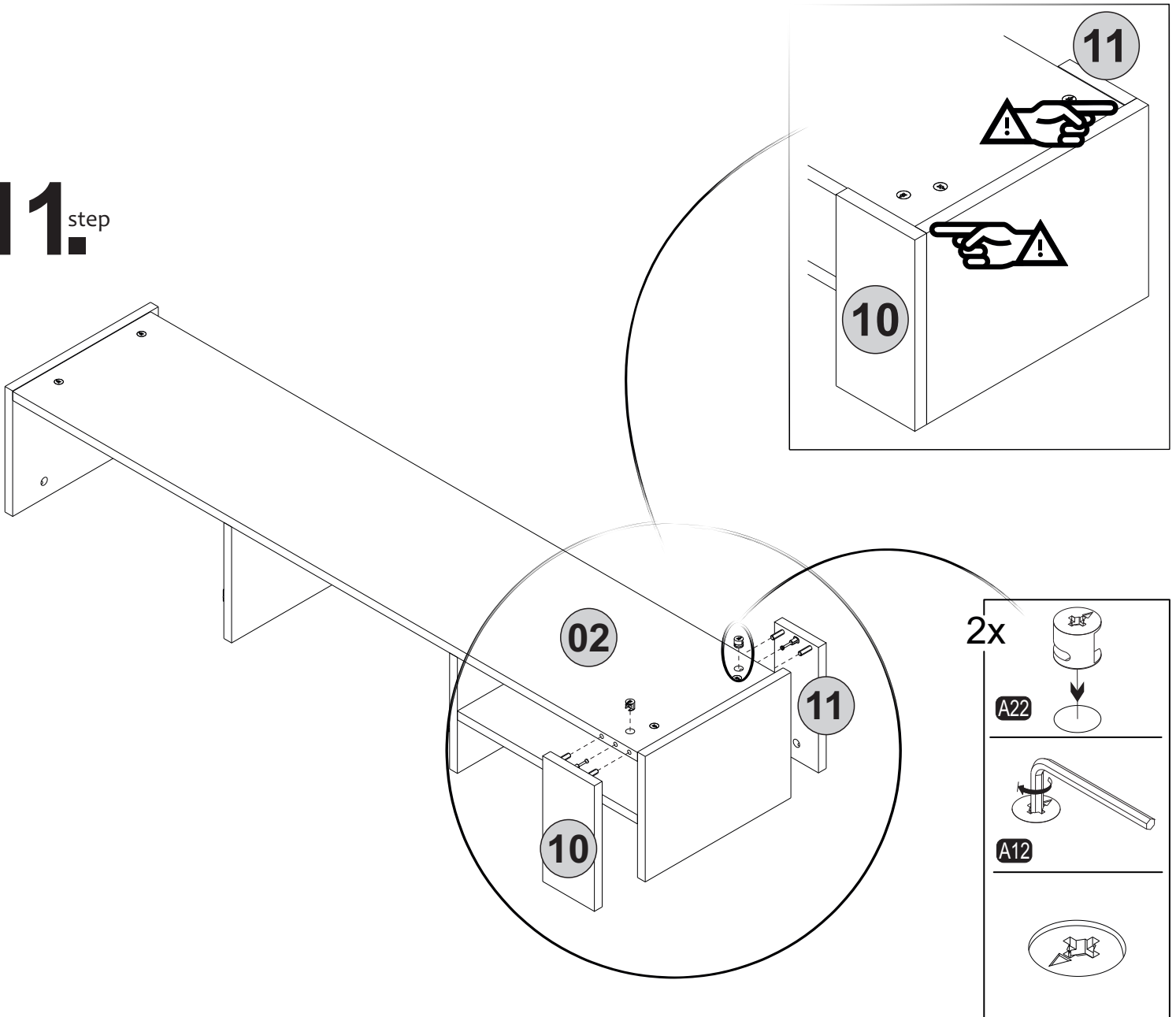

12.^{step}

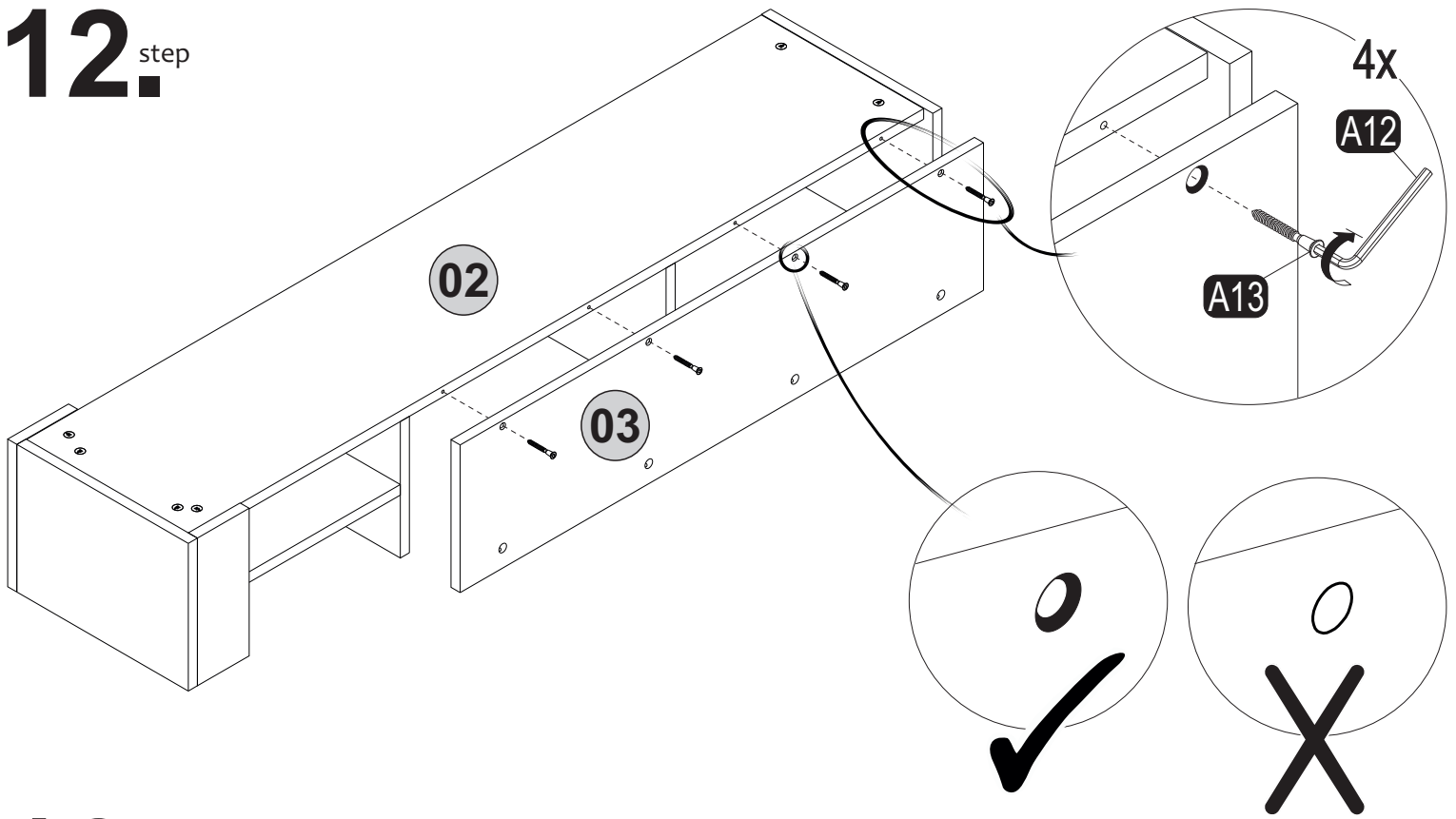

13.^{step}

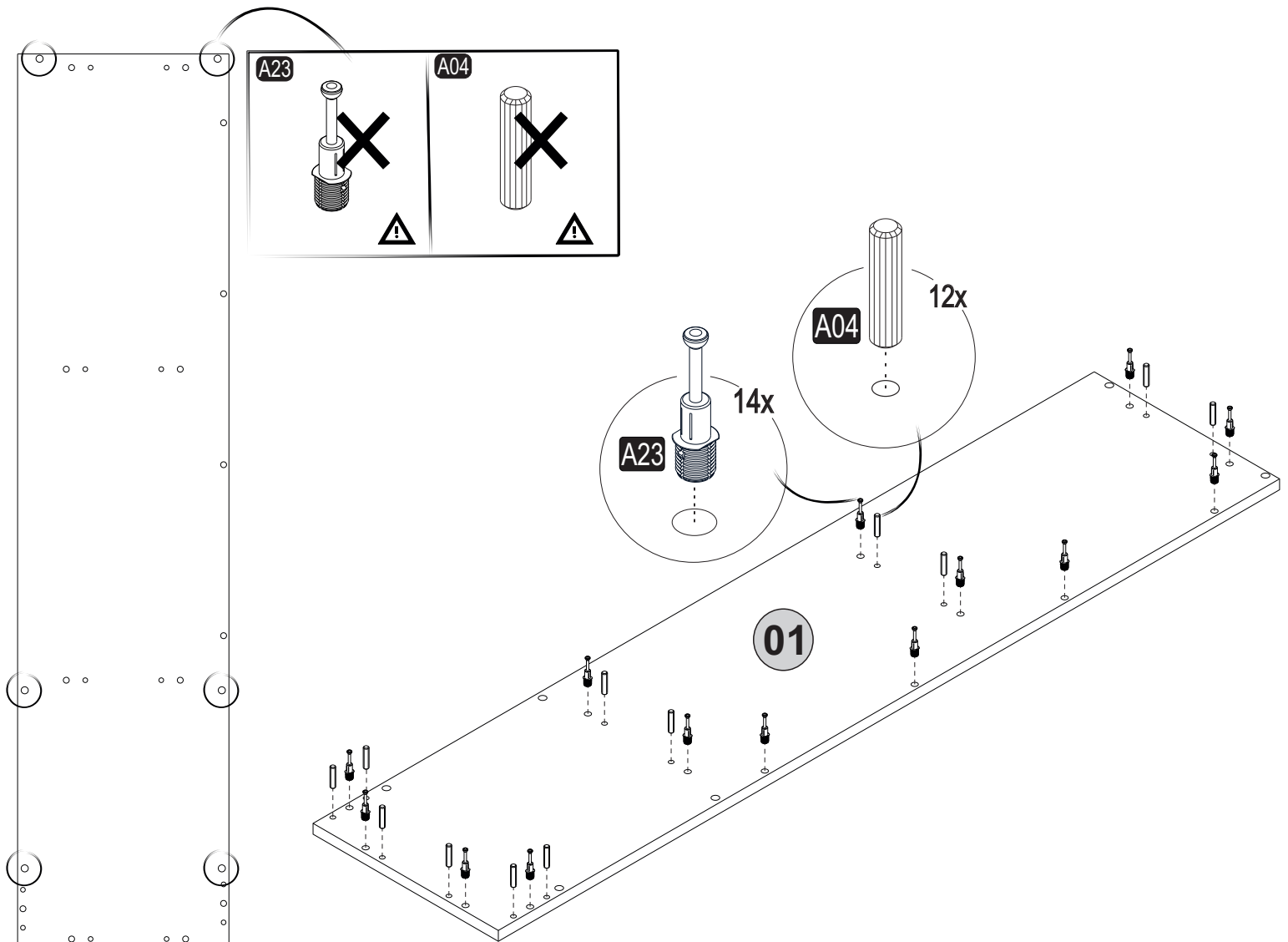

14. step

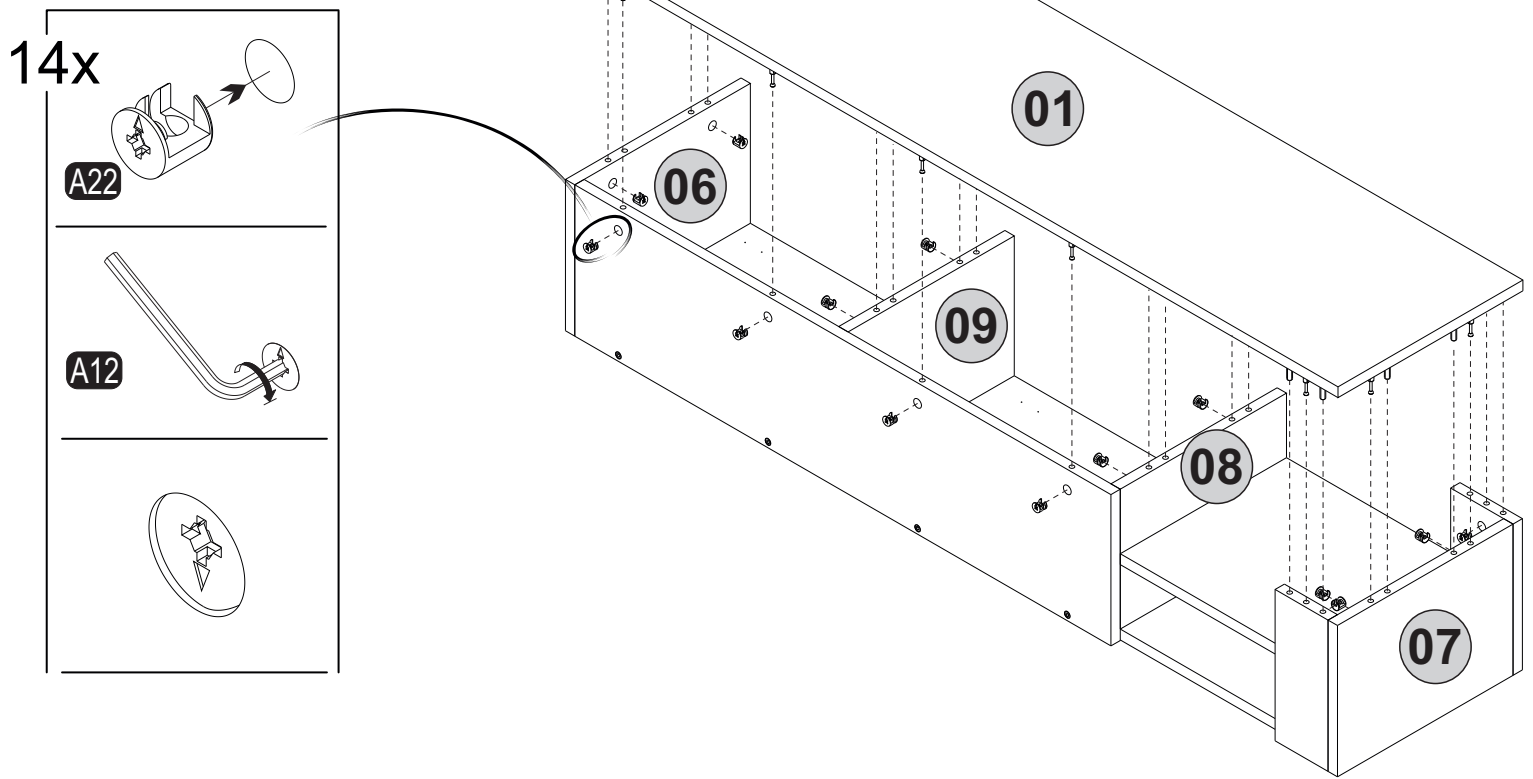

15. step

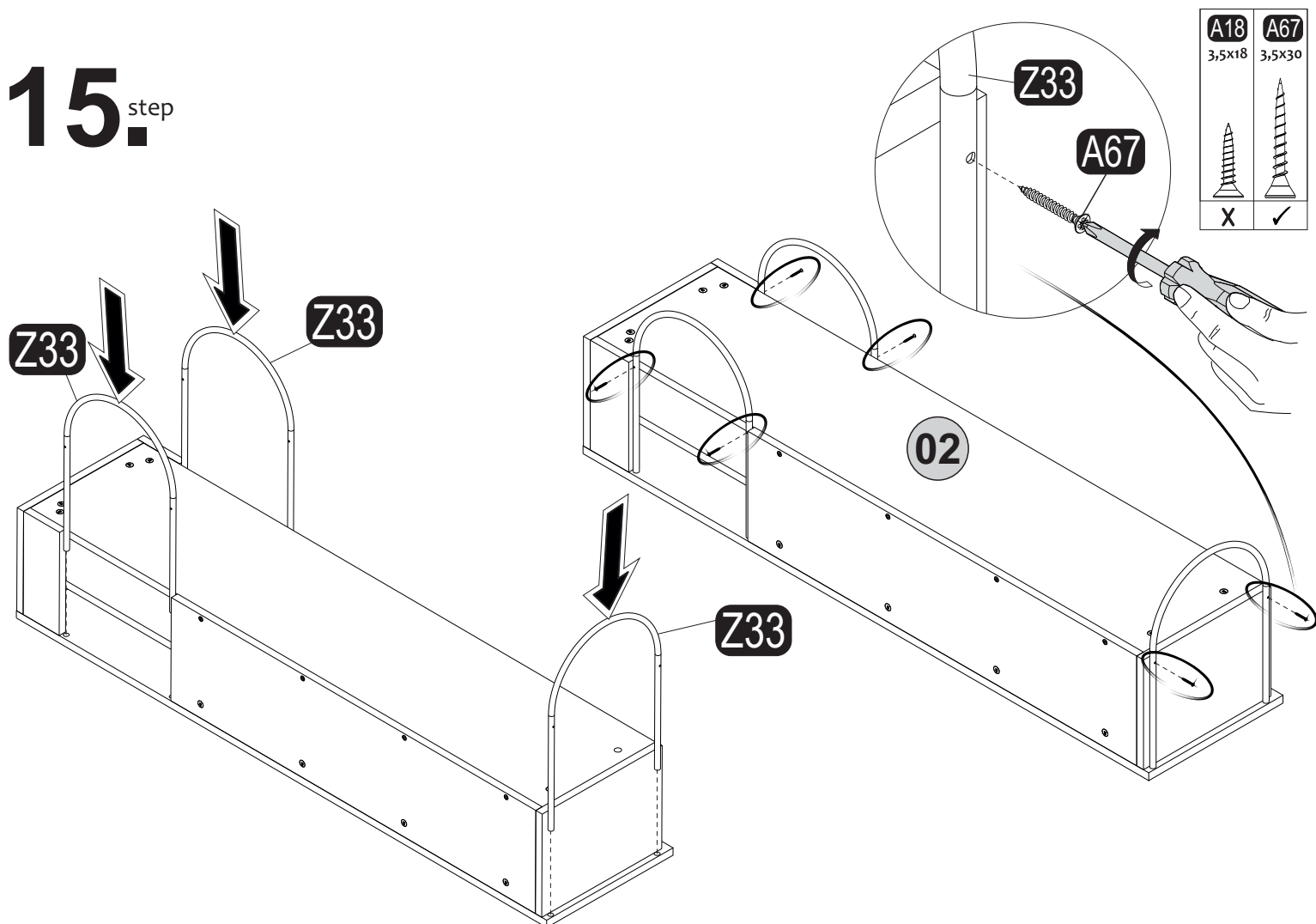

16.^{step}

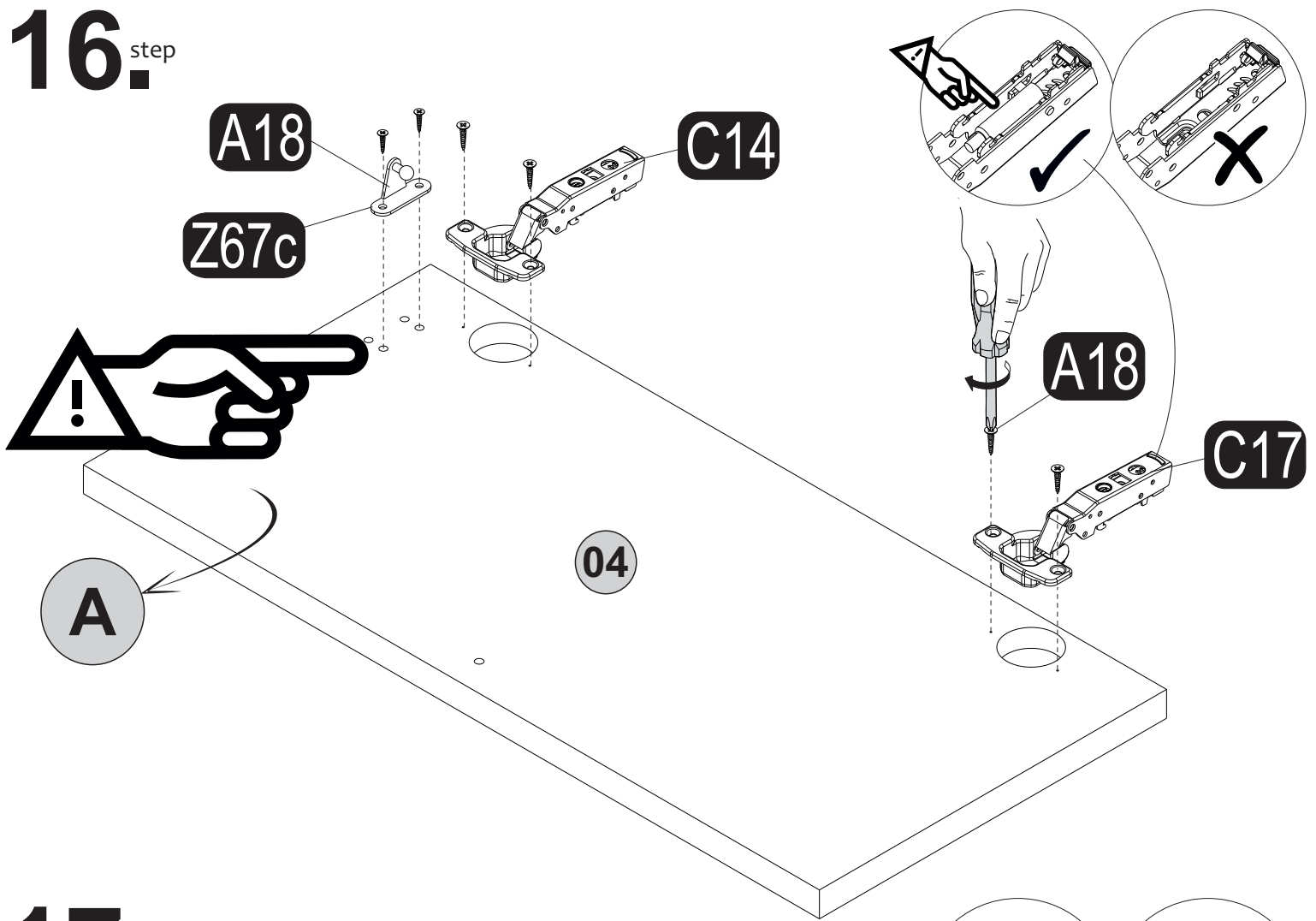

17.^{step}

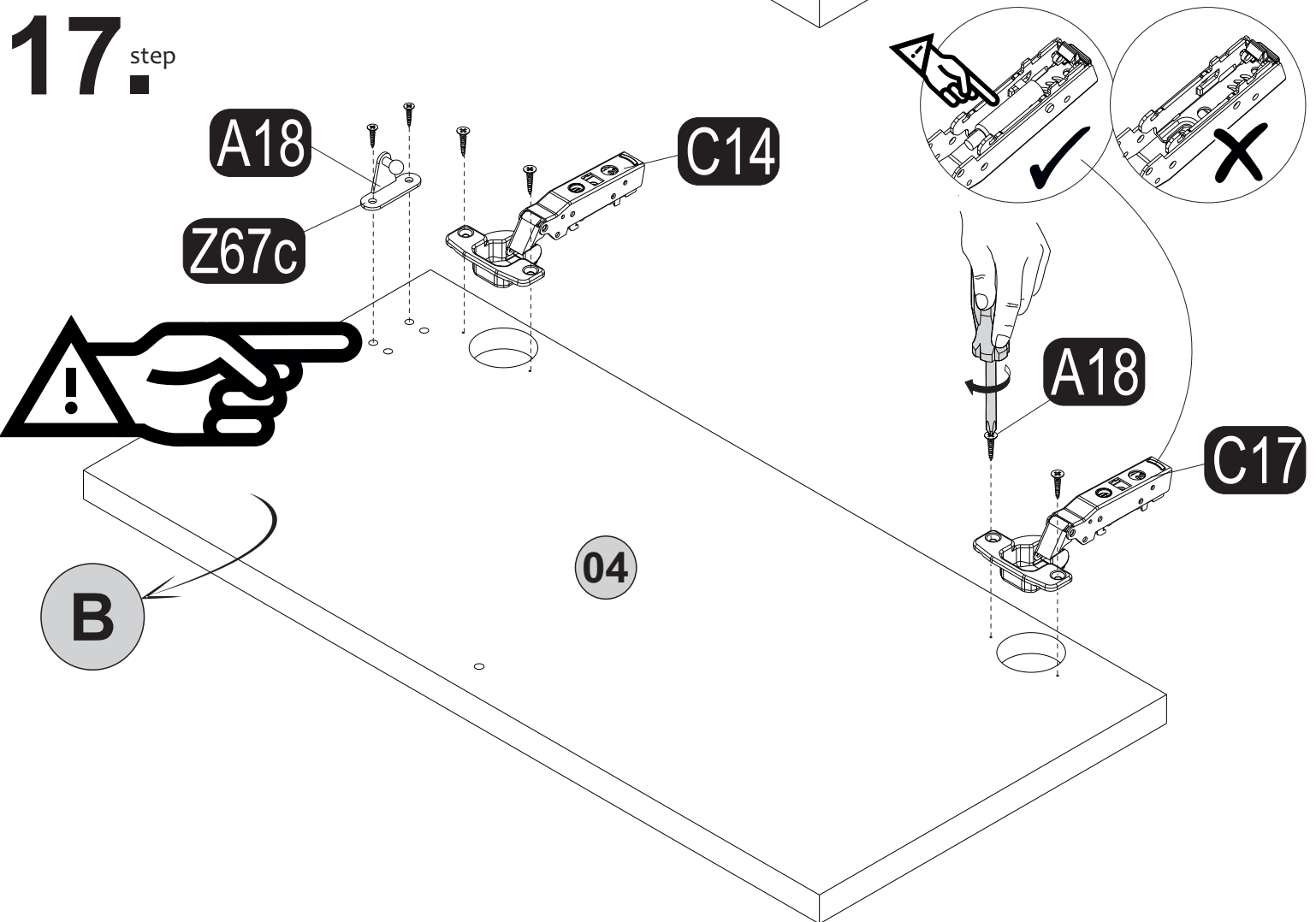

18.^{step}

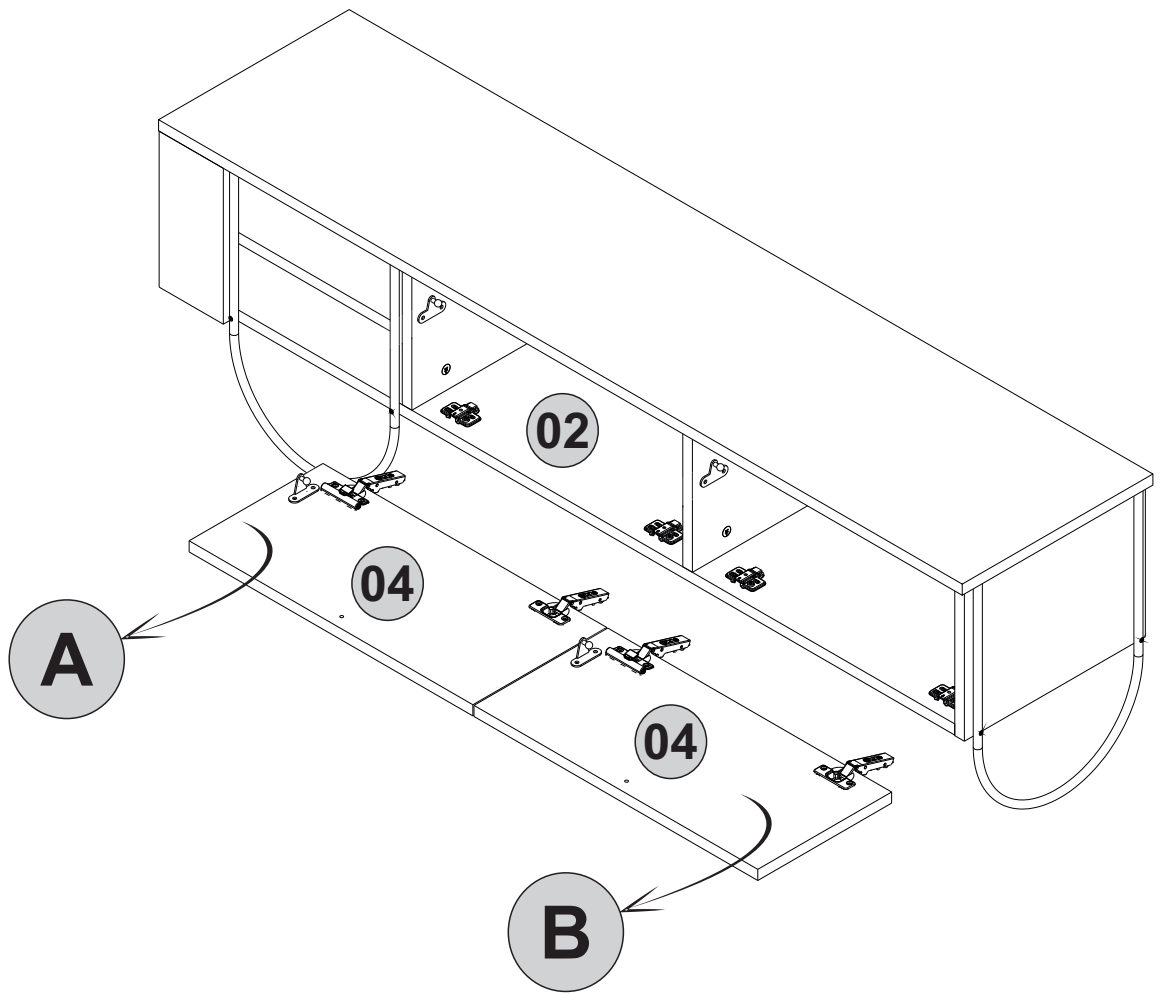
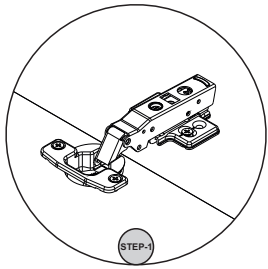
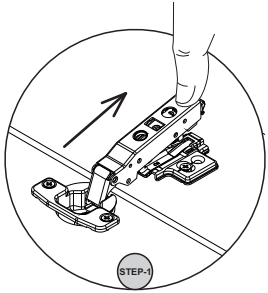
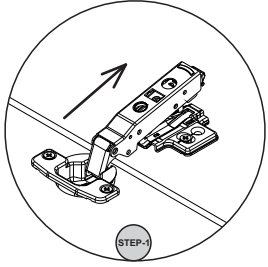

19.^{step}

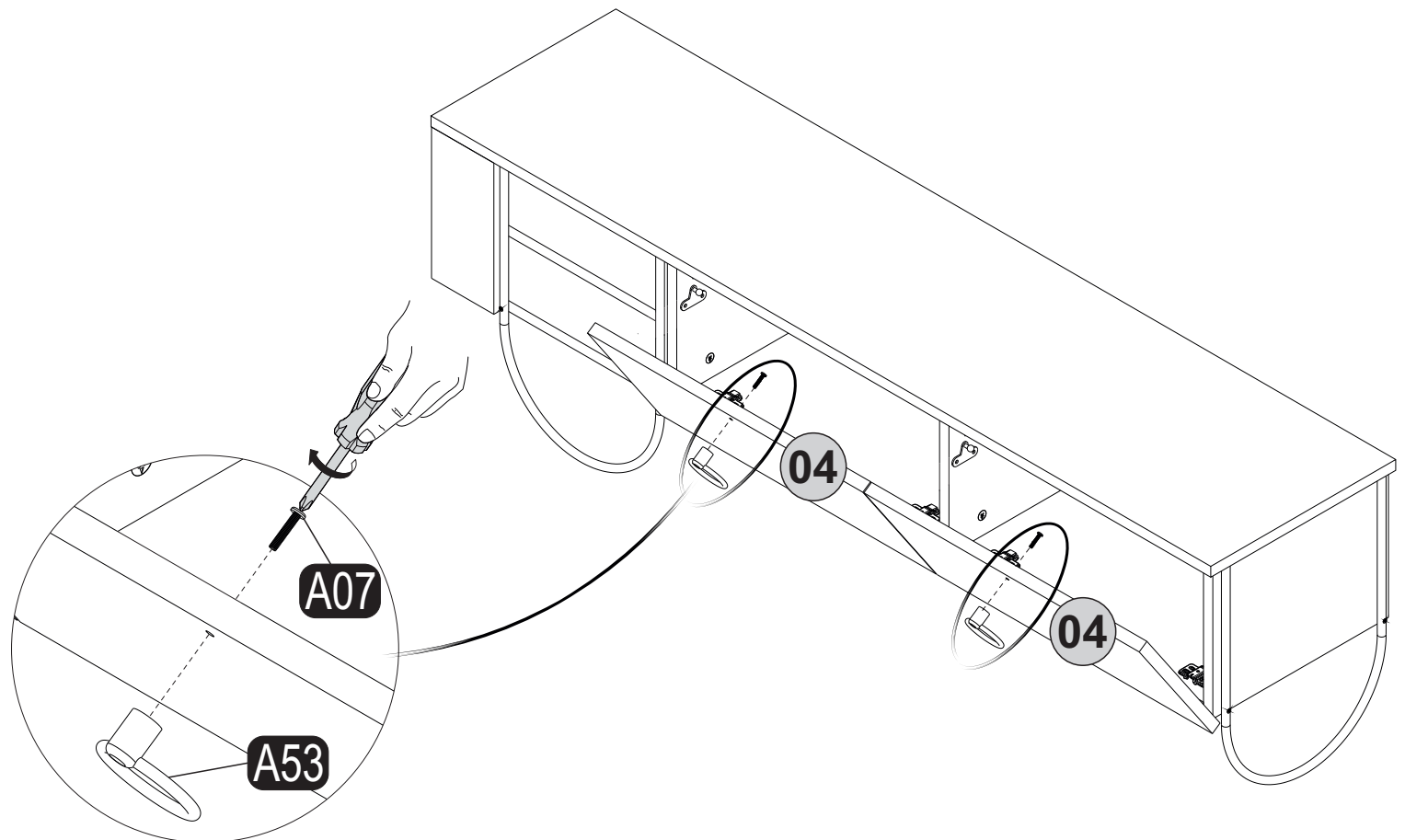

20^{step}

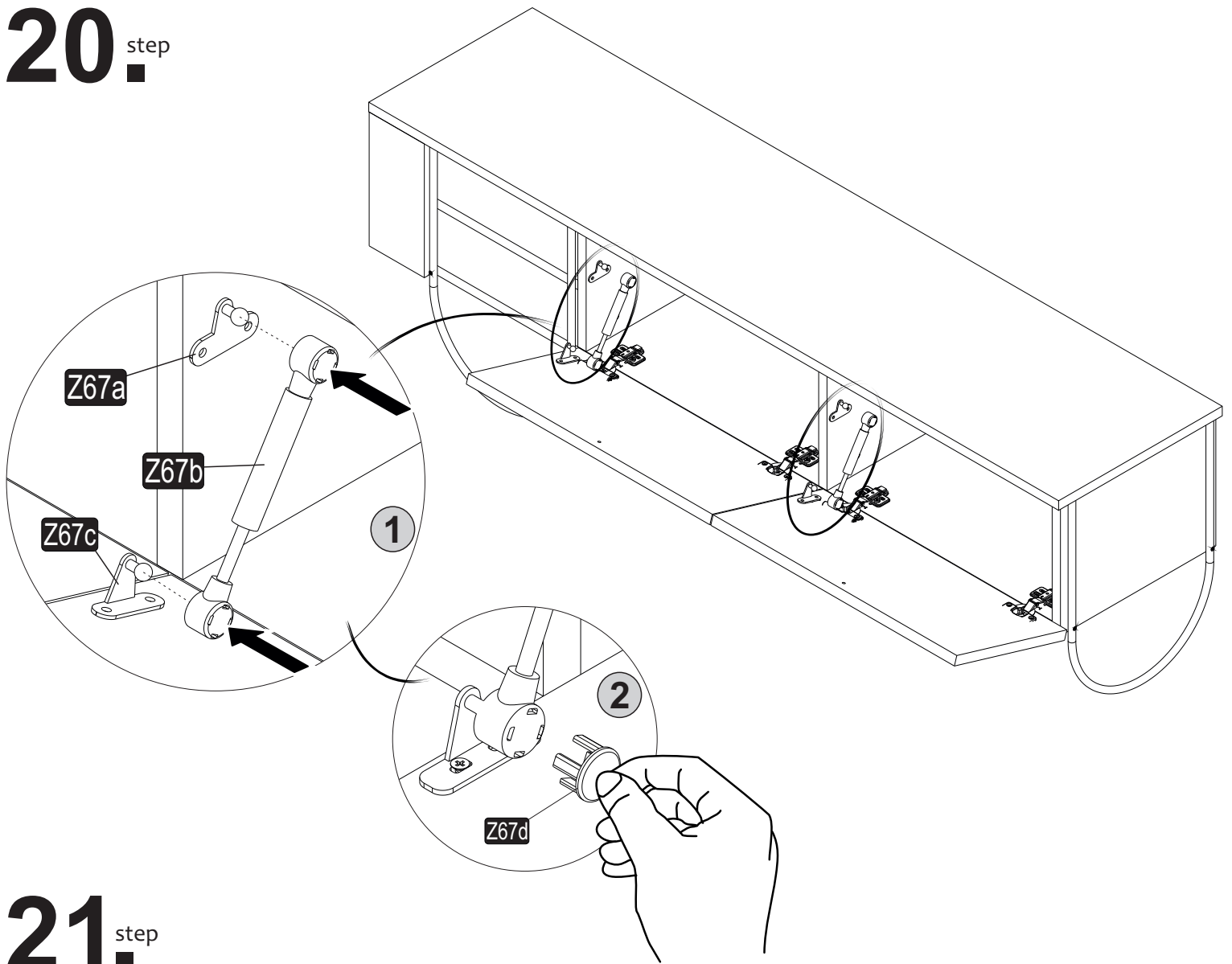

21^{step}

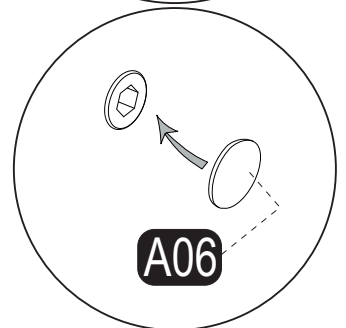
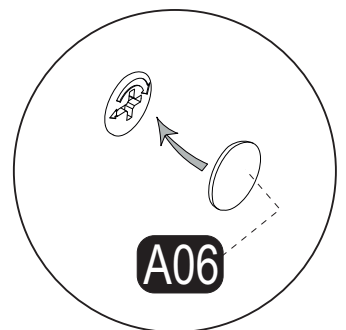
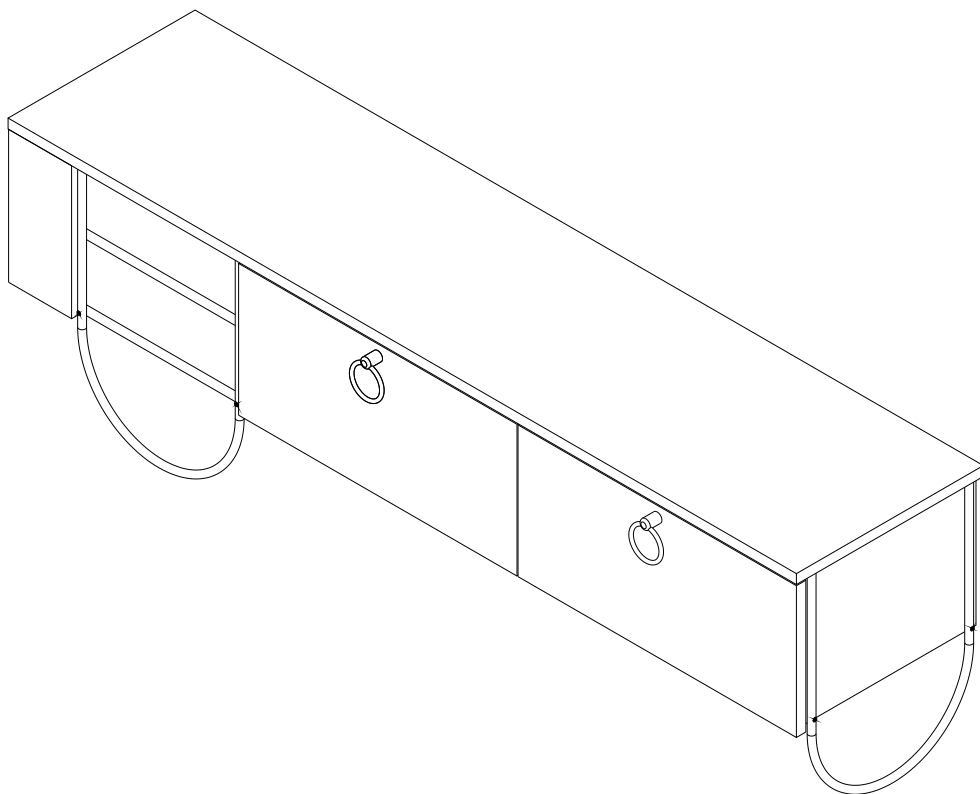

22_{step}

