

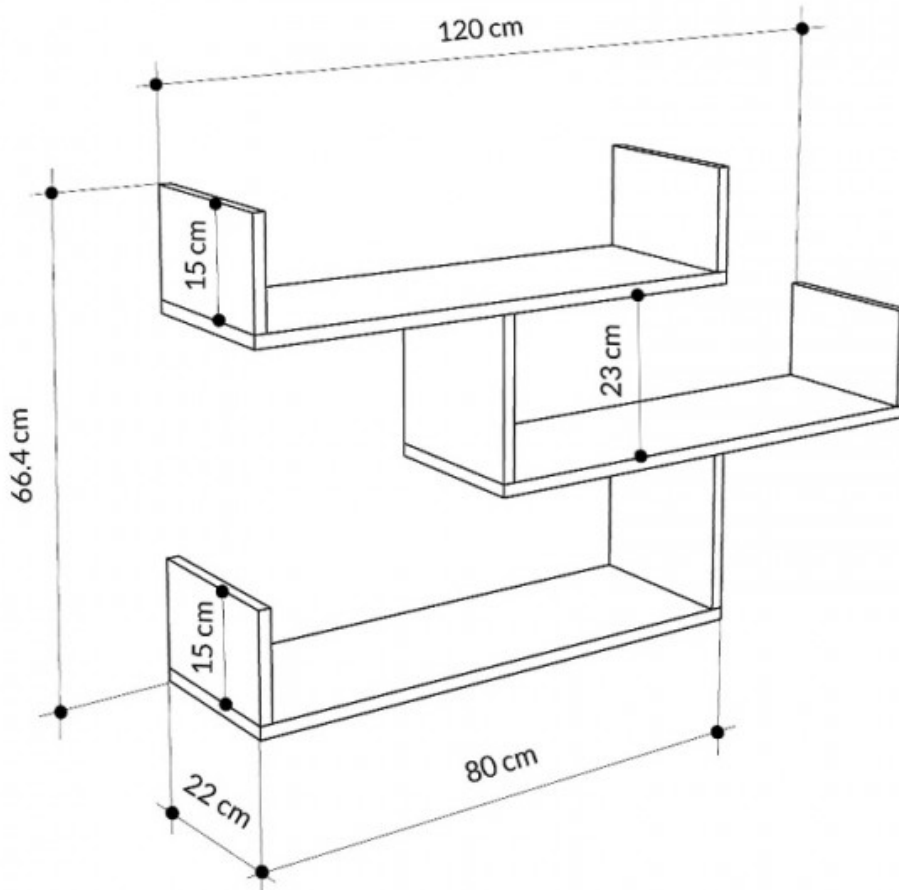







i GP037-0042,1

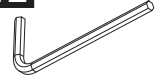

A13  50mm 16x	A12  4 sw 1x	A32  60/16 5x	Z18  Gbdy 5x	A11  3,5x30 10x
A16  DbØ8 5x	A17  4x50 5x	A06  18mm 16x		

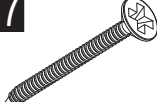

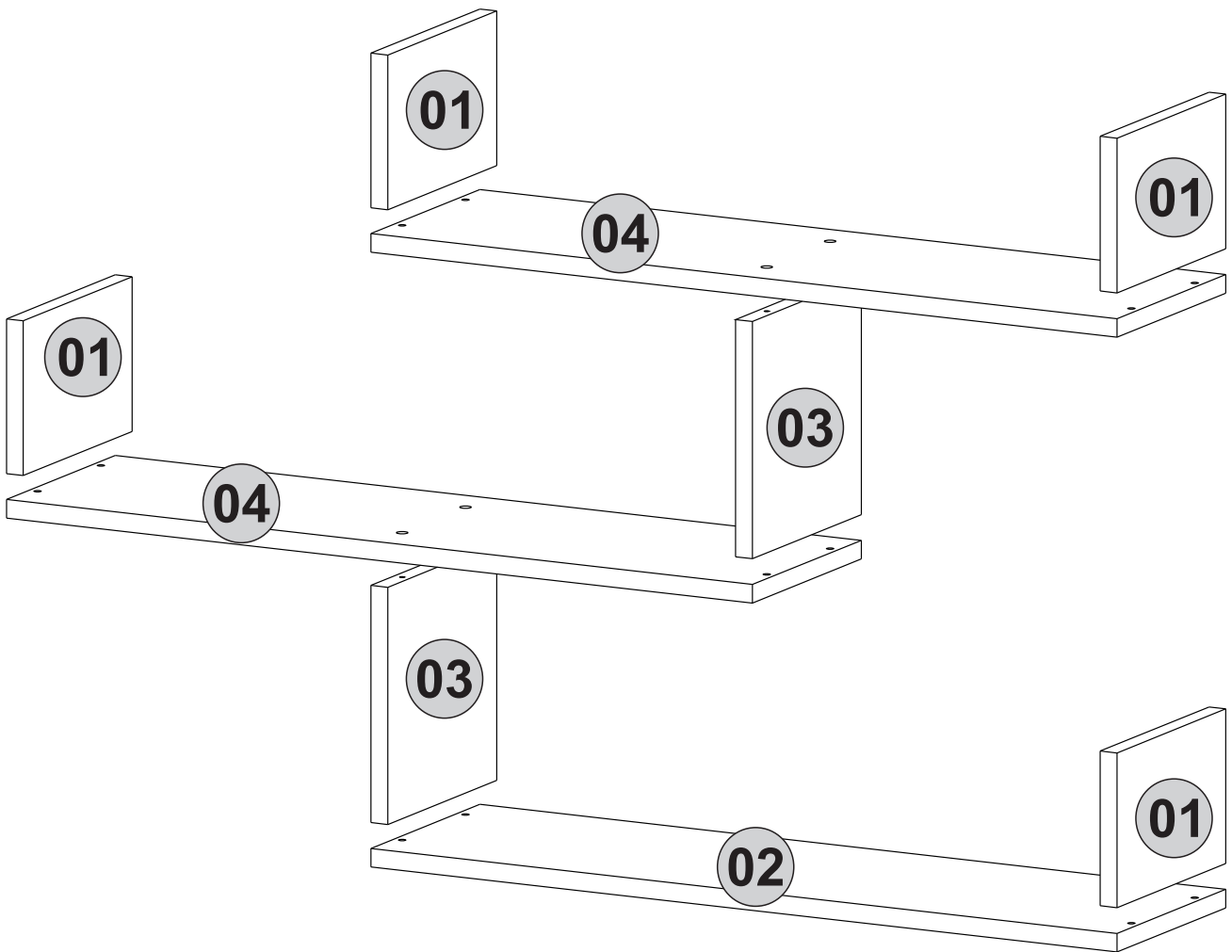
1. step

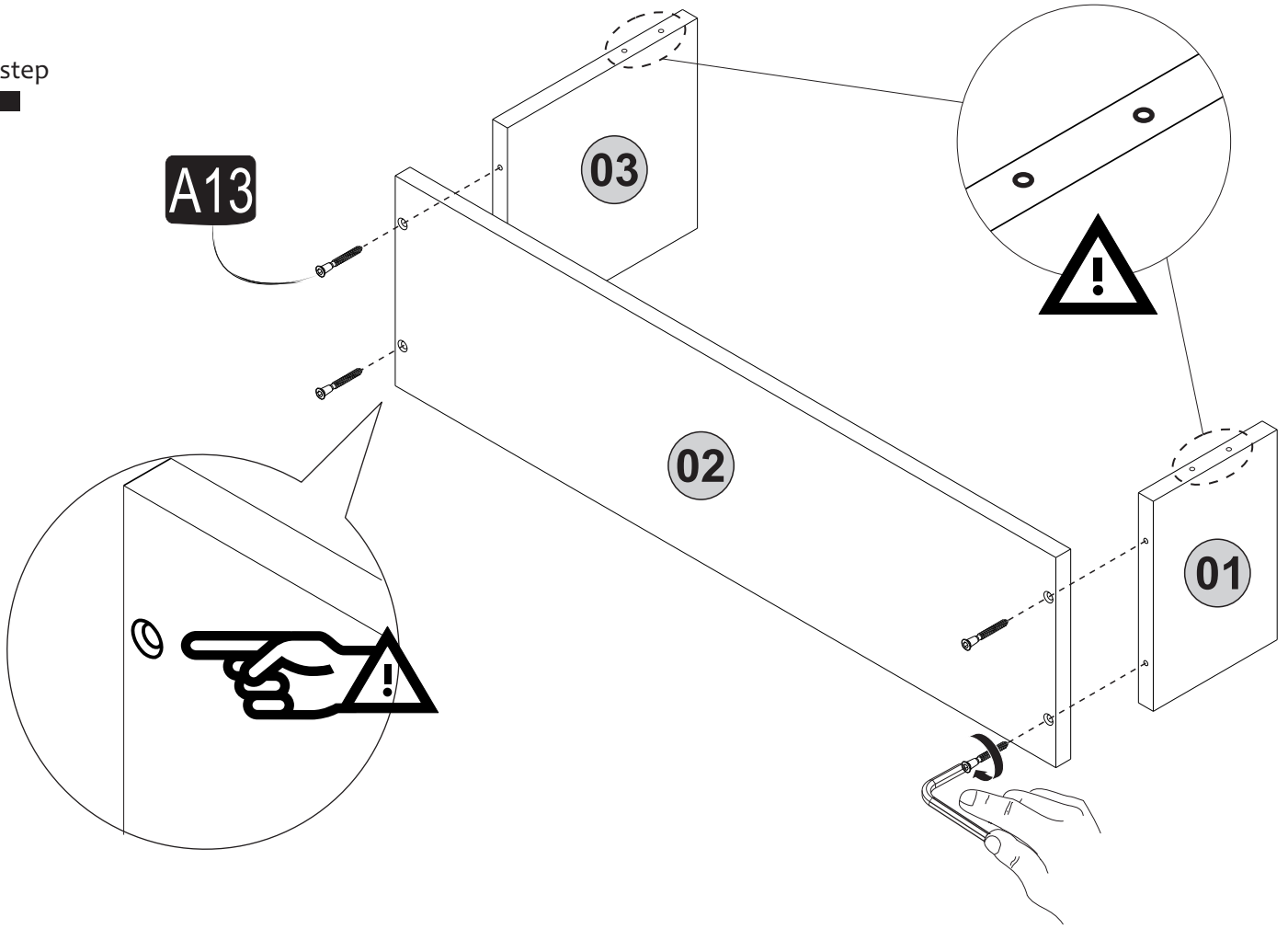

2. step

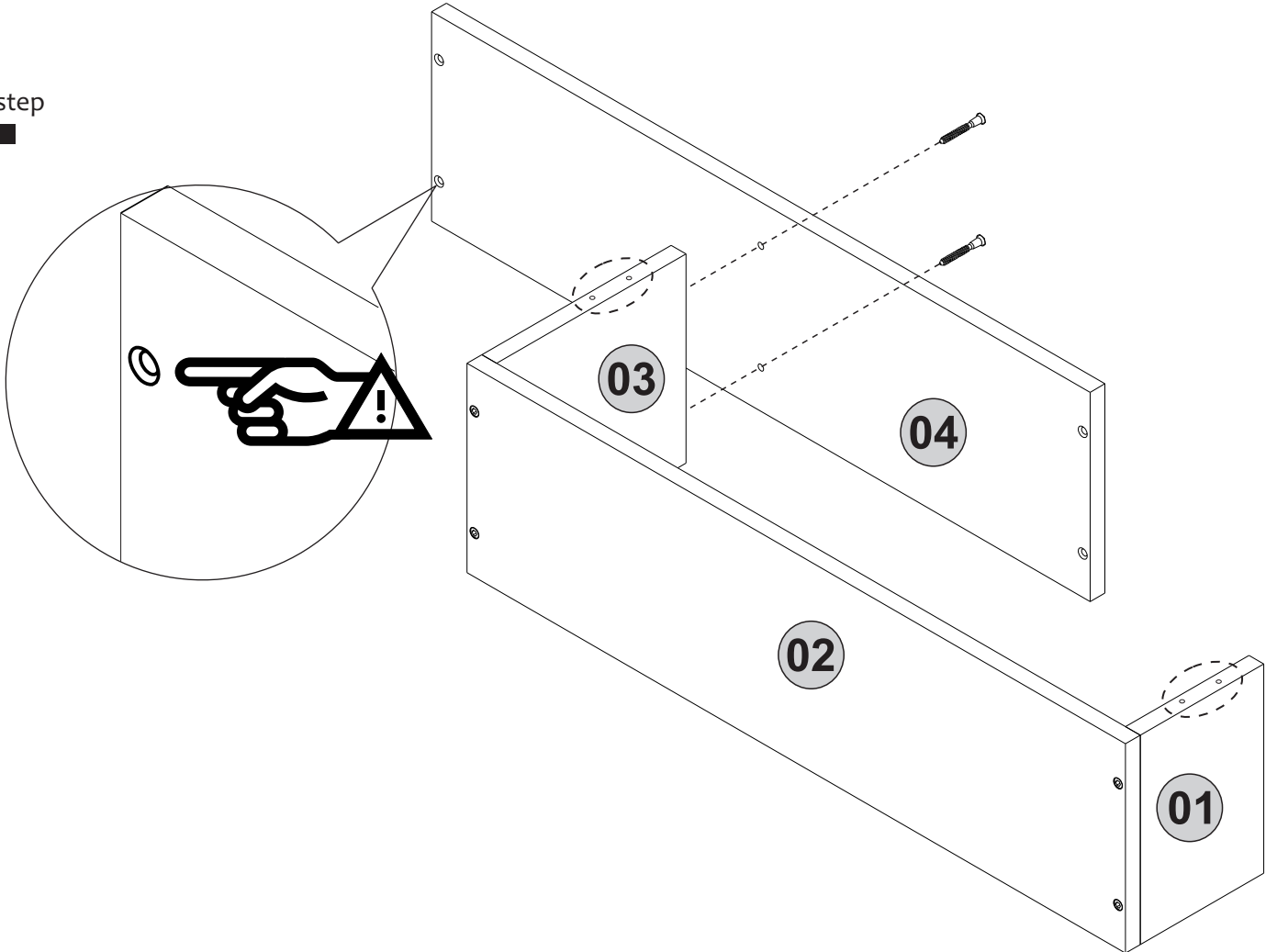

3 step

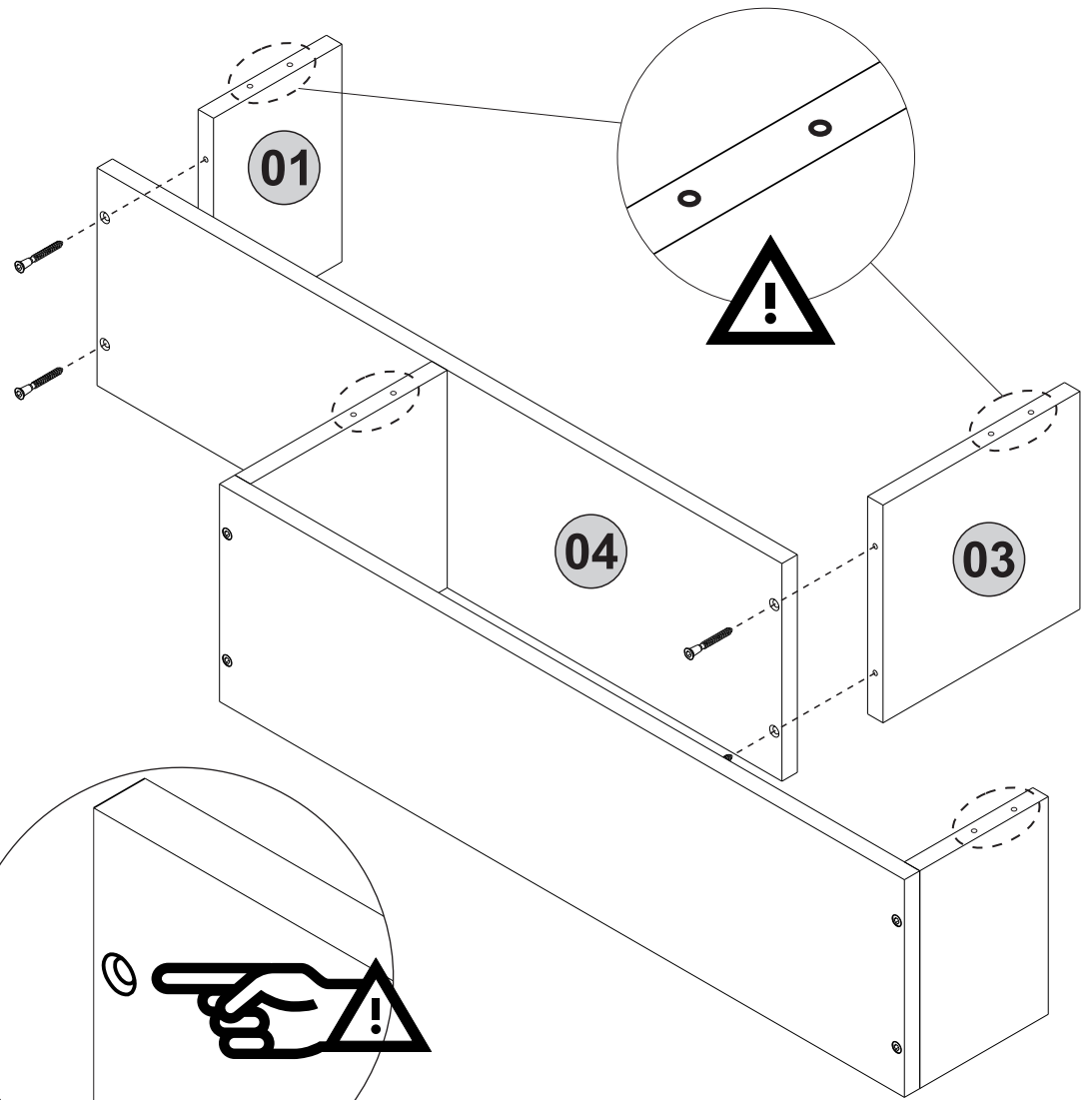

4 step

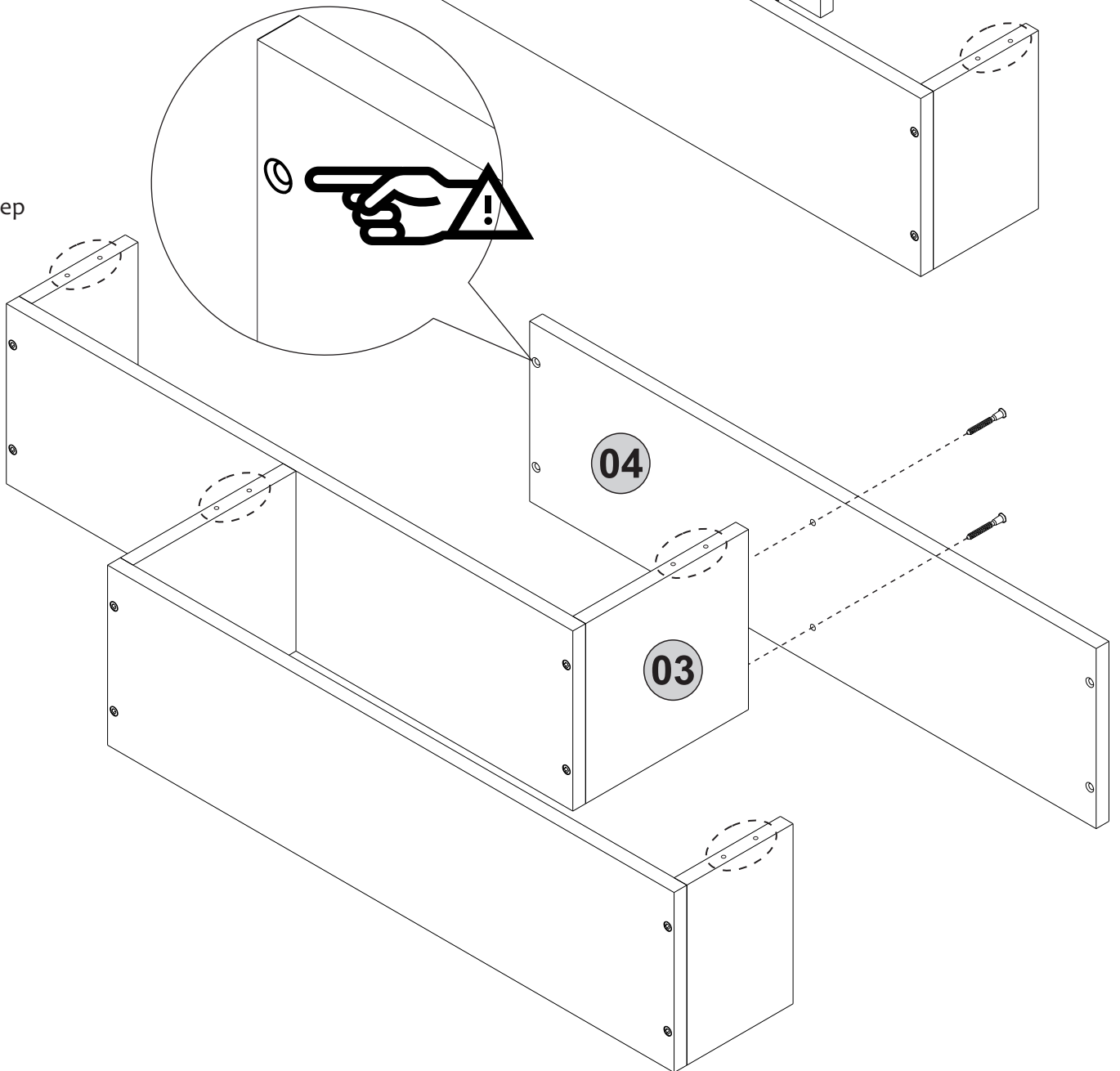

5_{step}

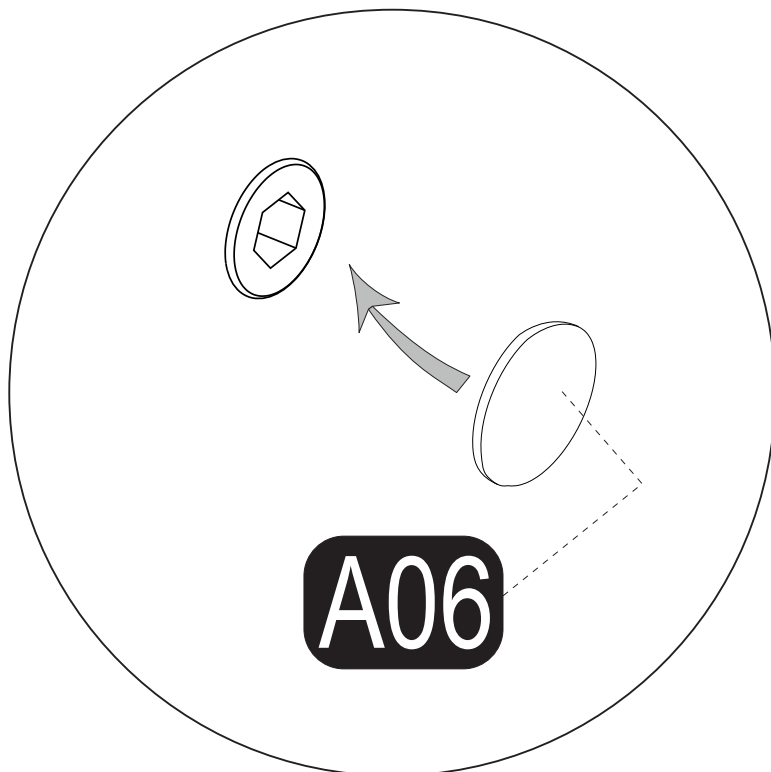
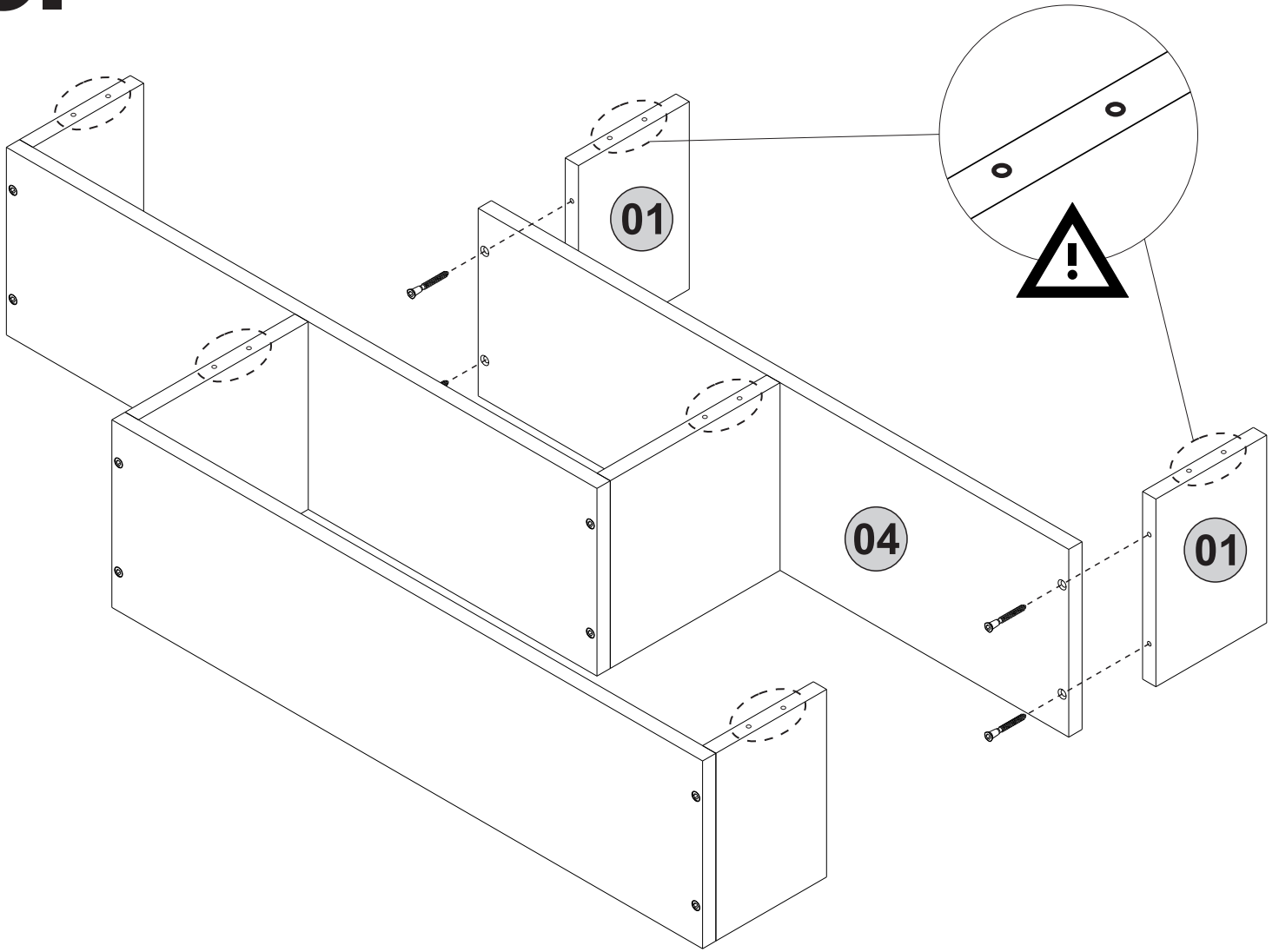

6^{step}

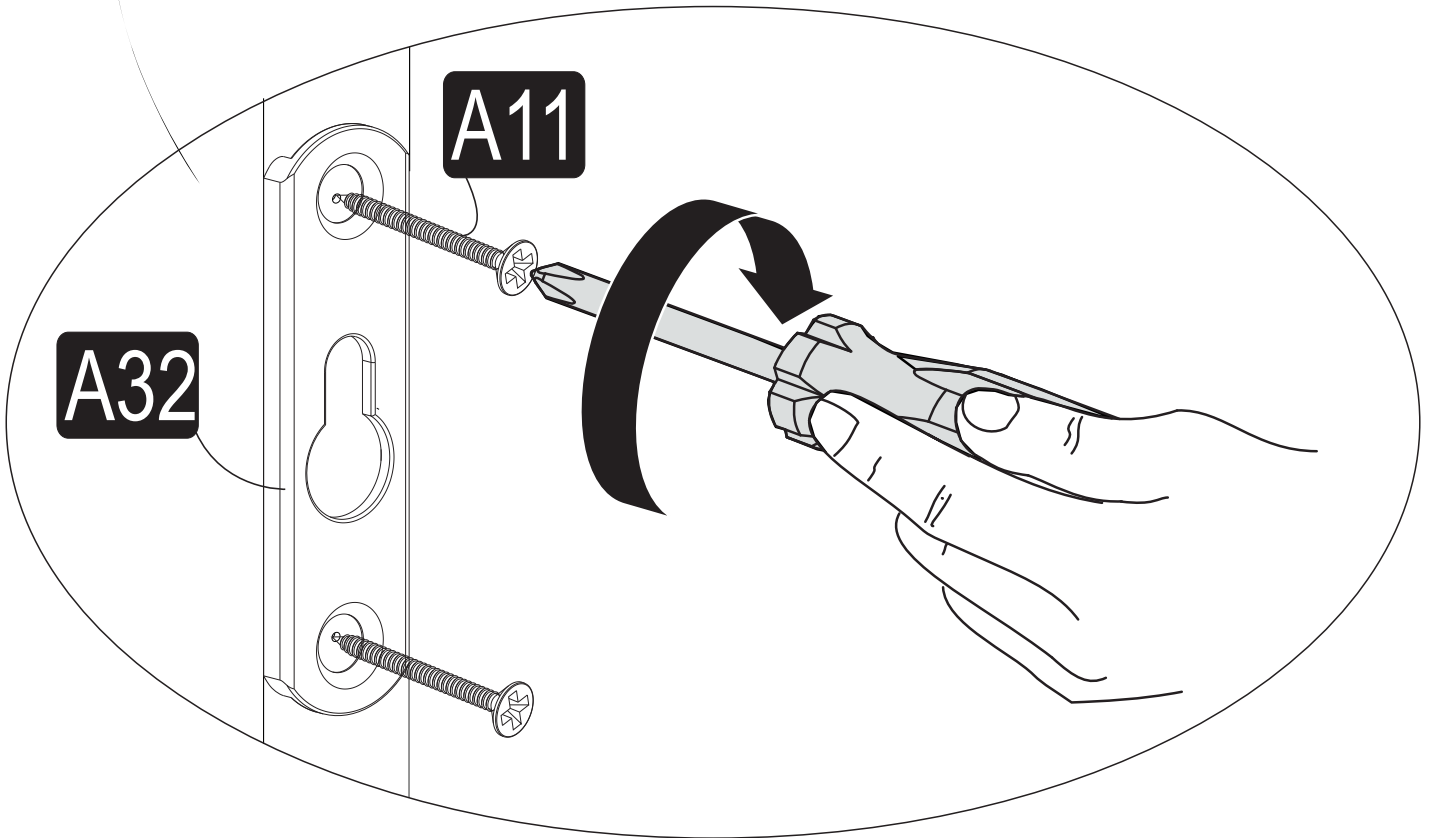
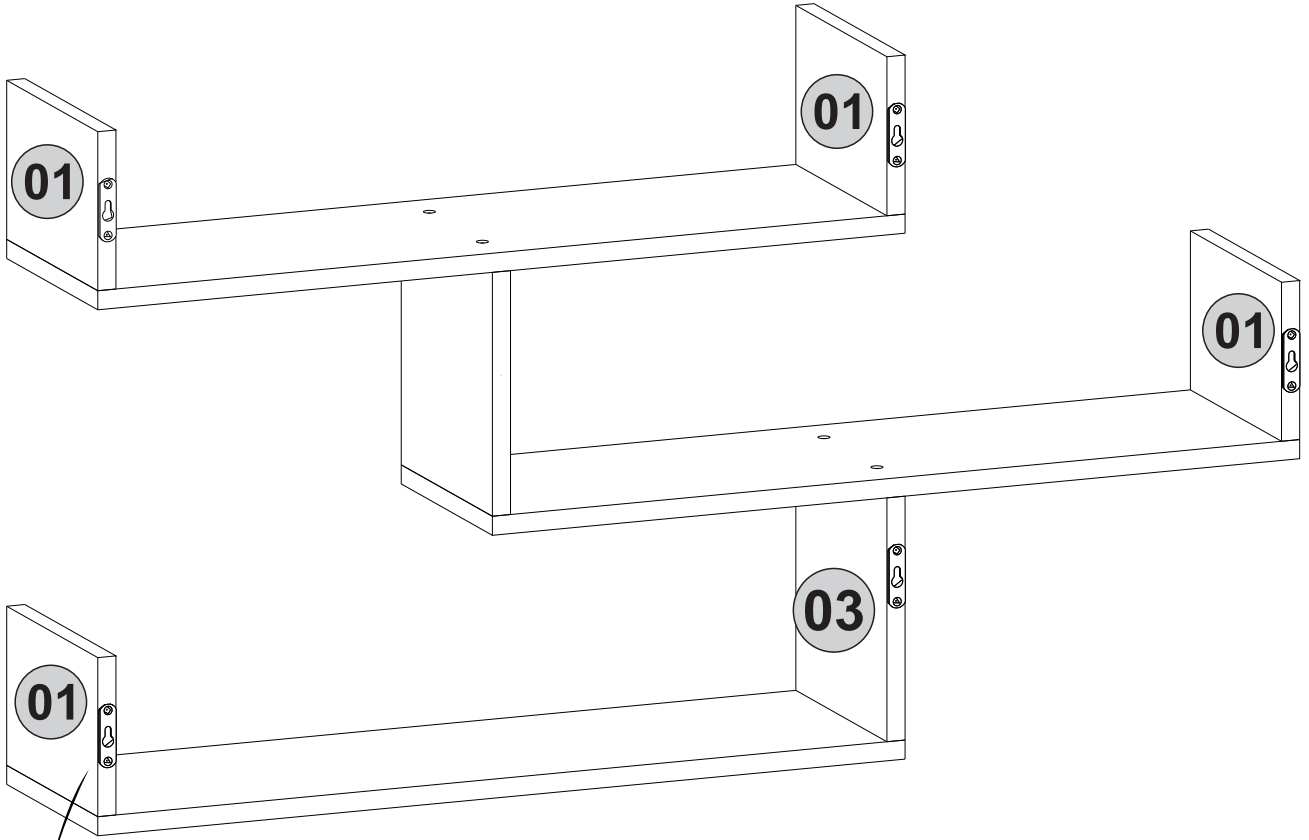

7 step

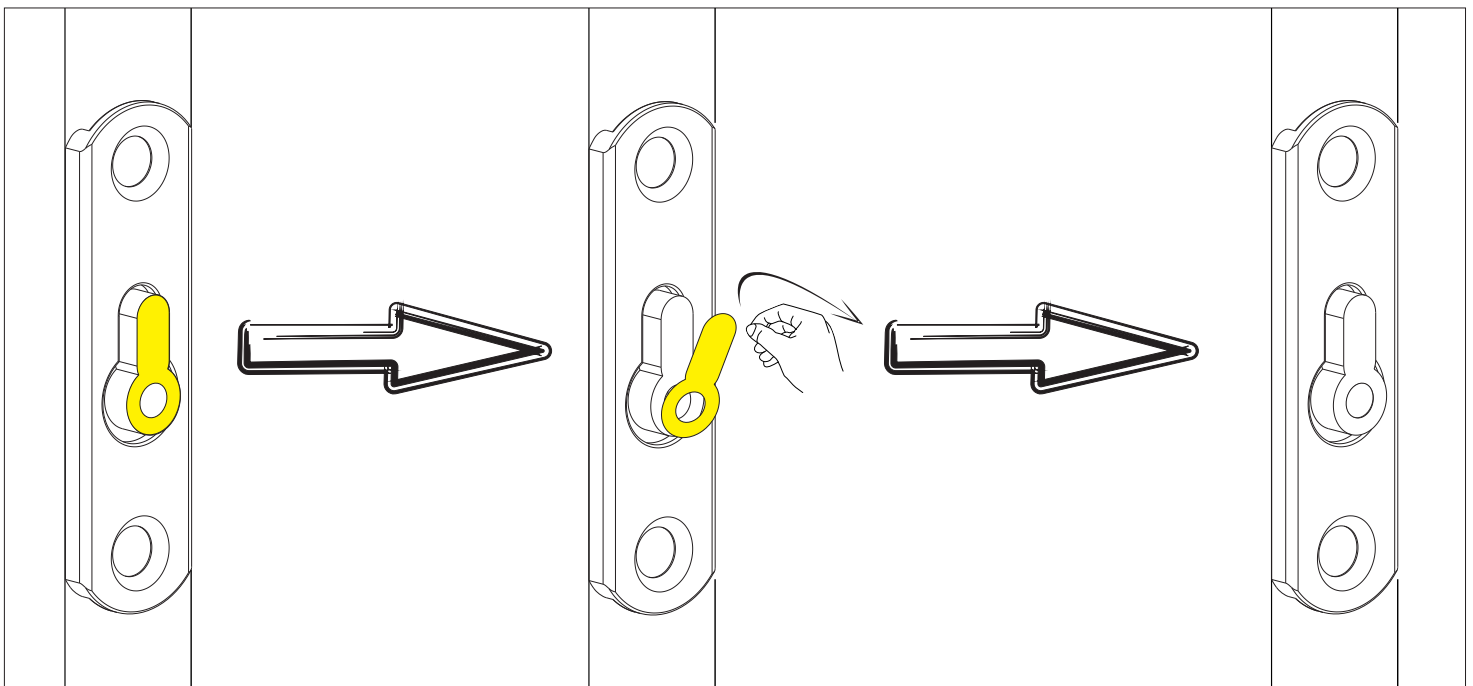
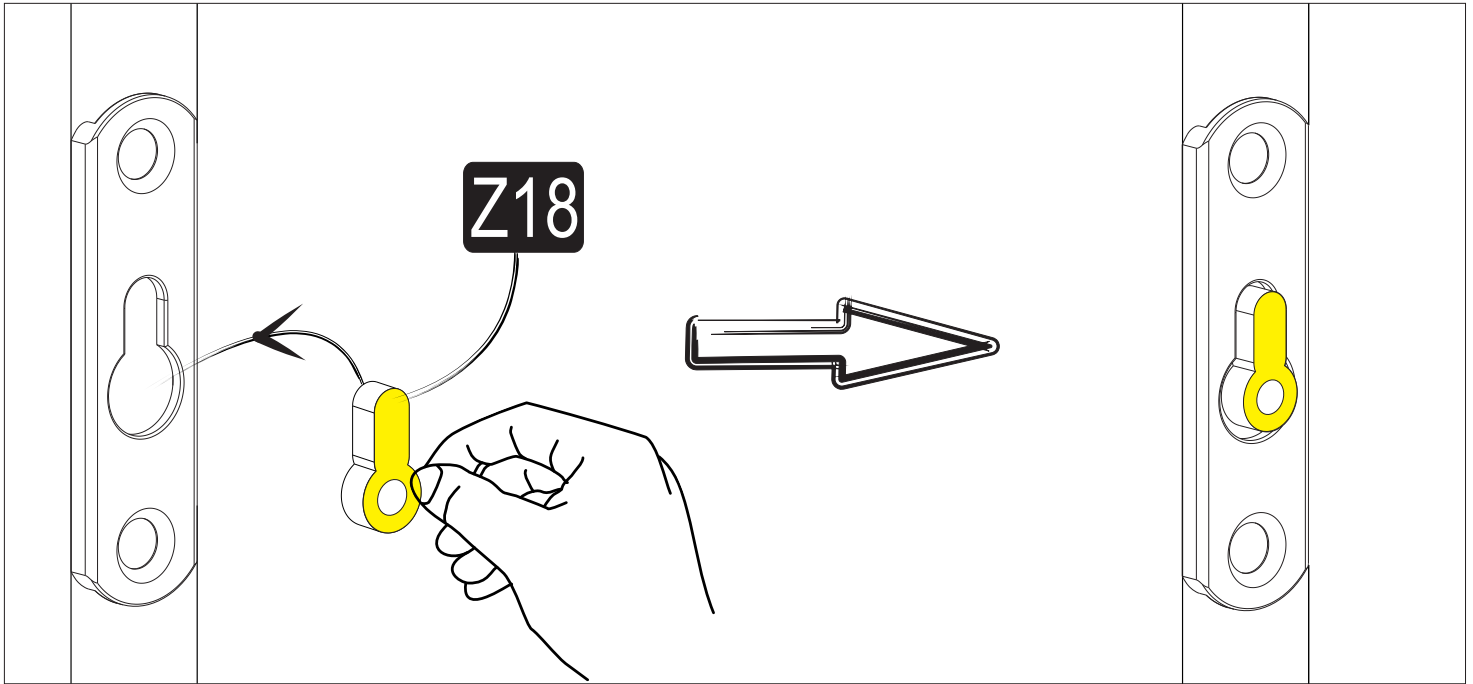

8 step

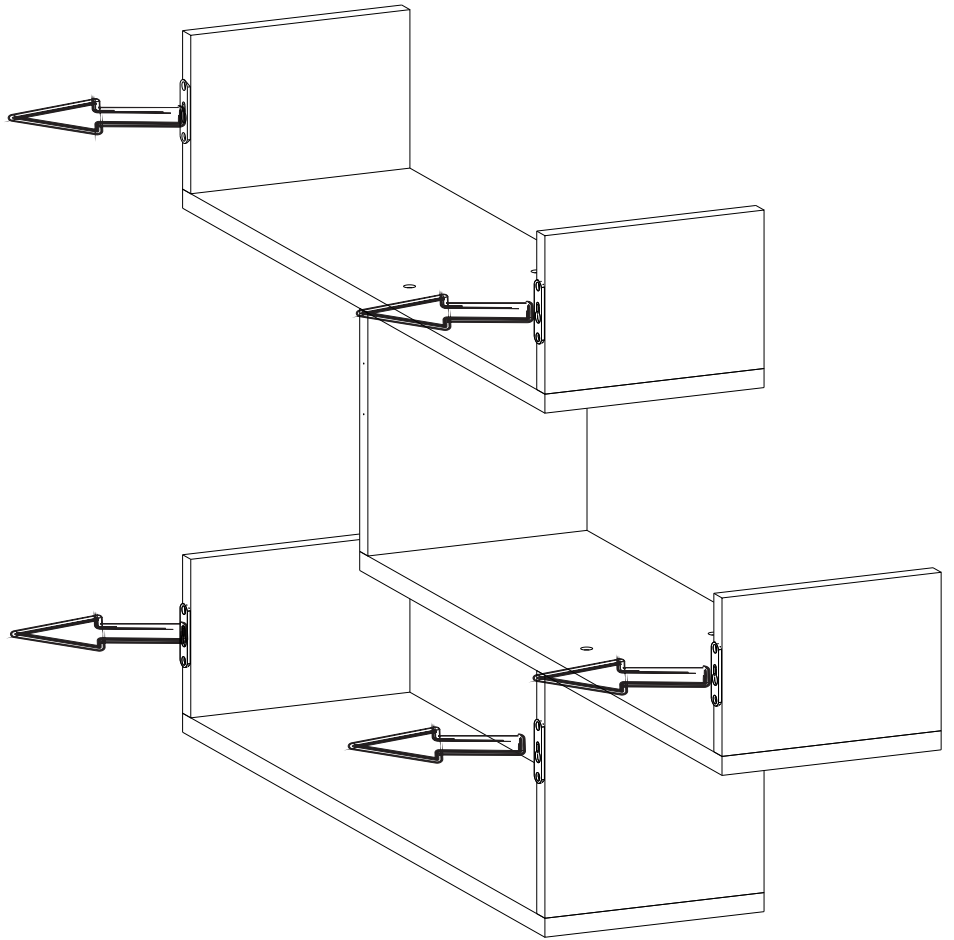
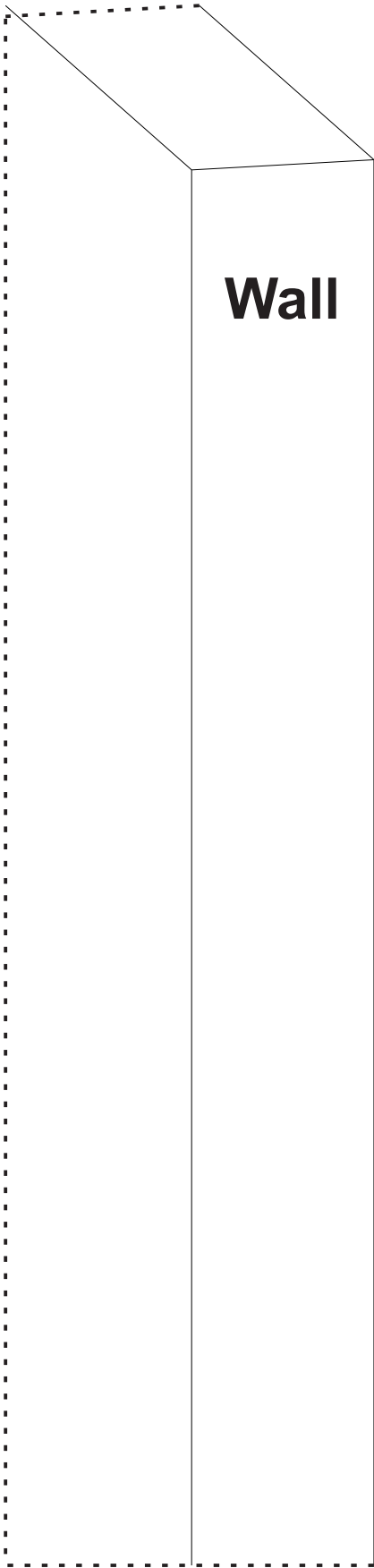
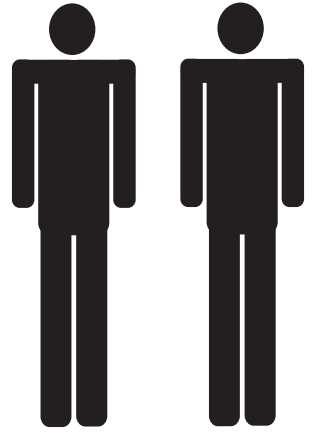

9^{step}

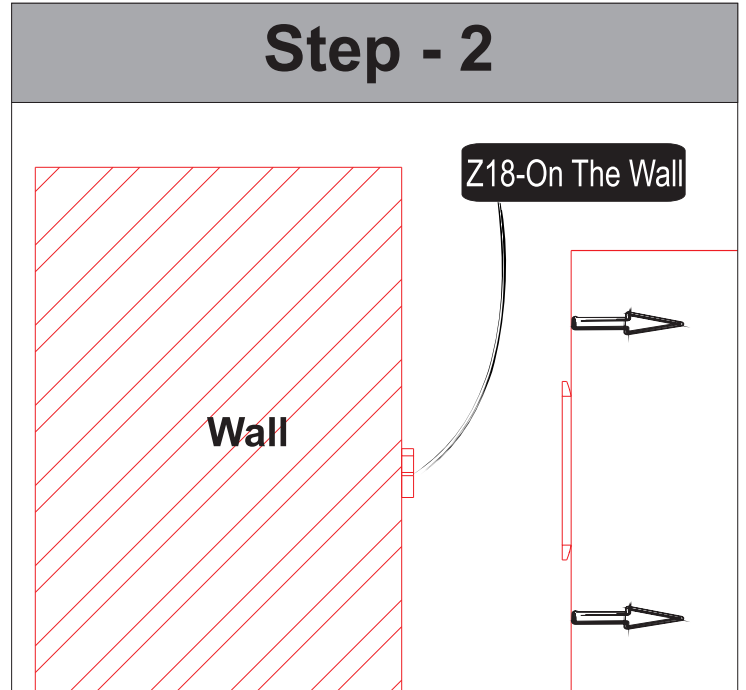
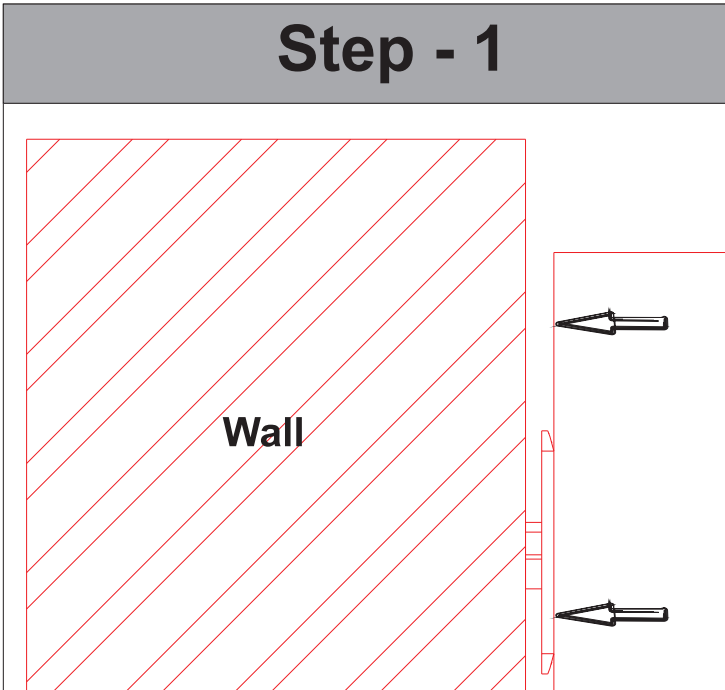
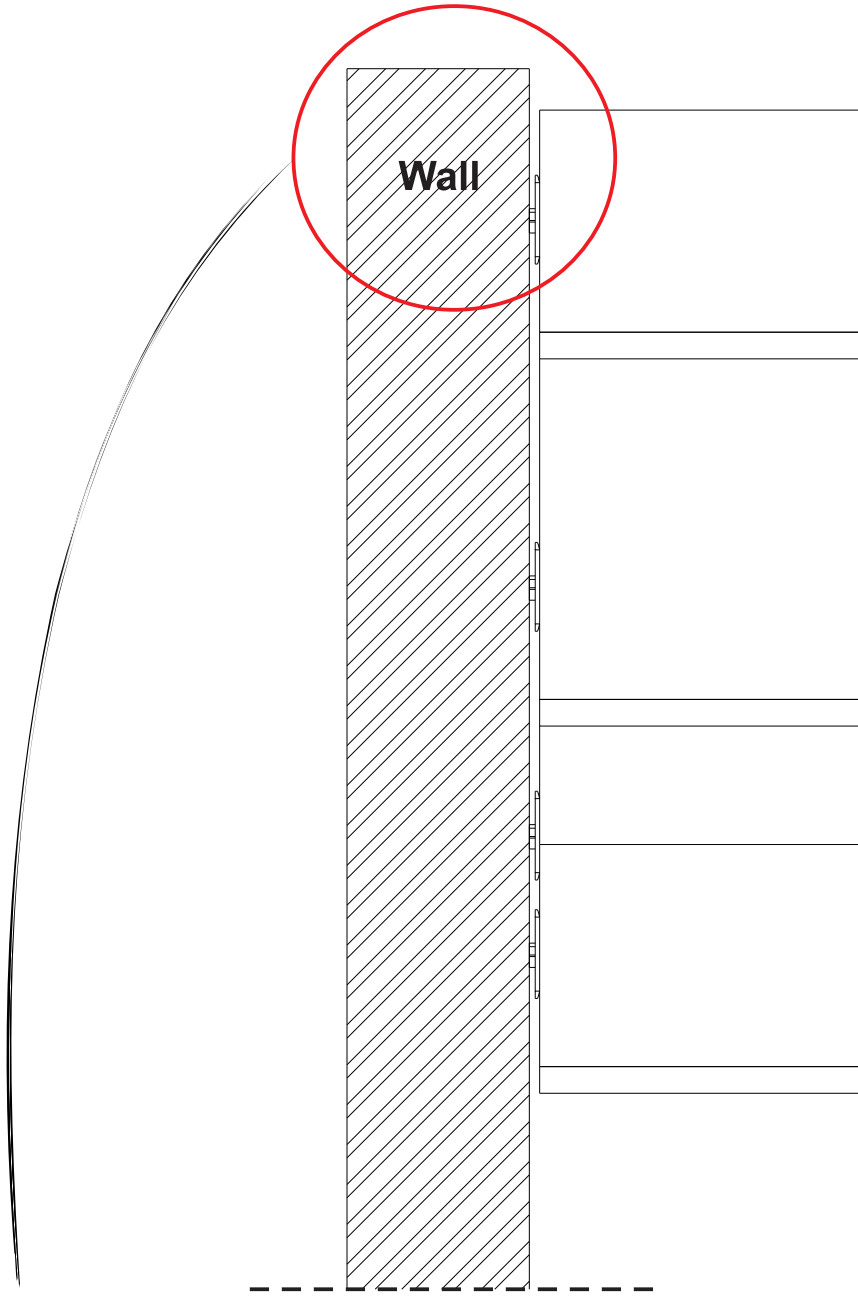

10.^{step}

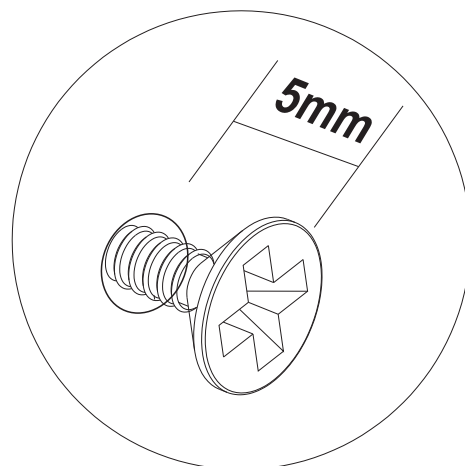
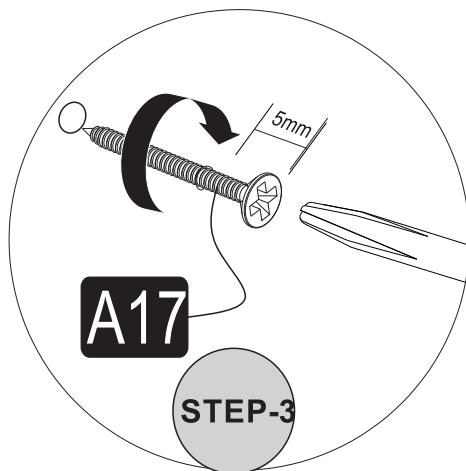
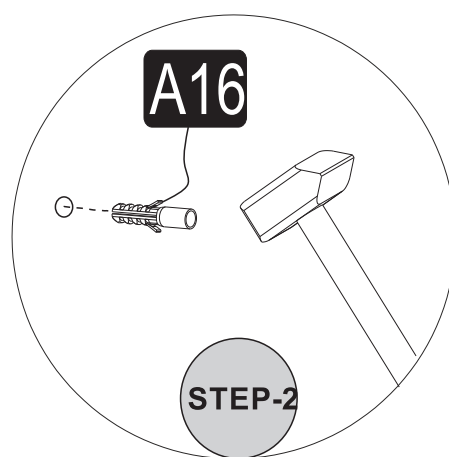
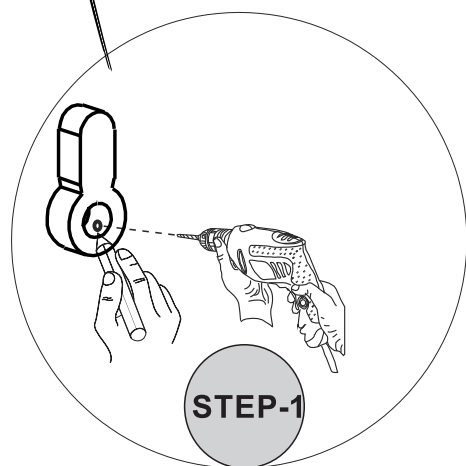
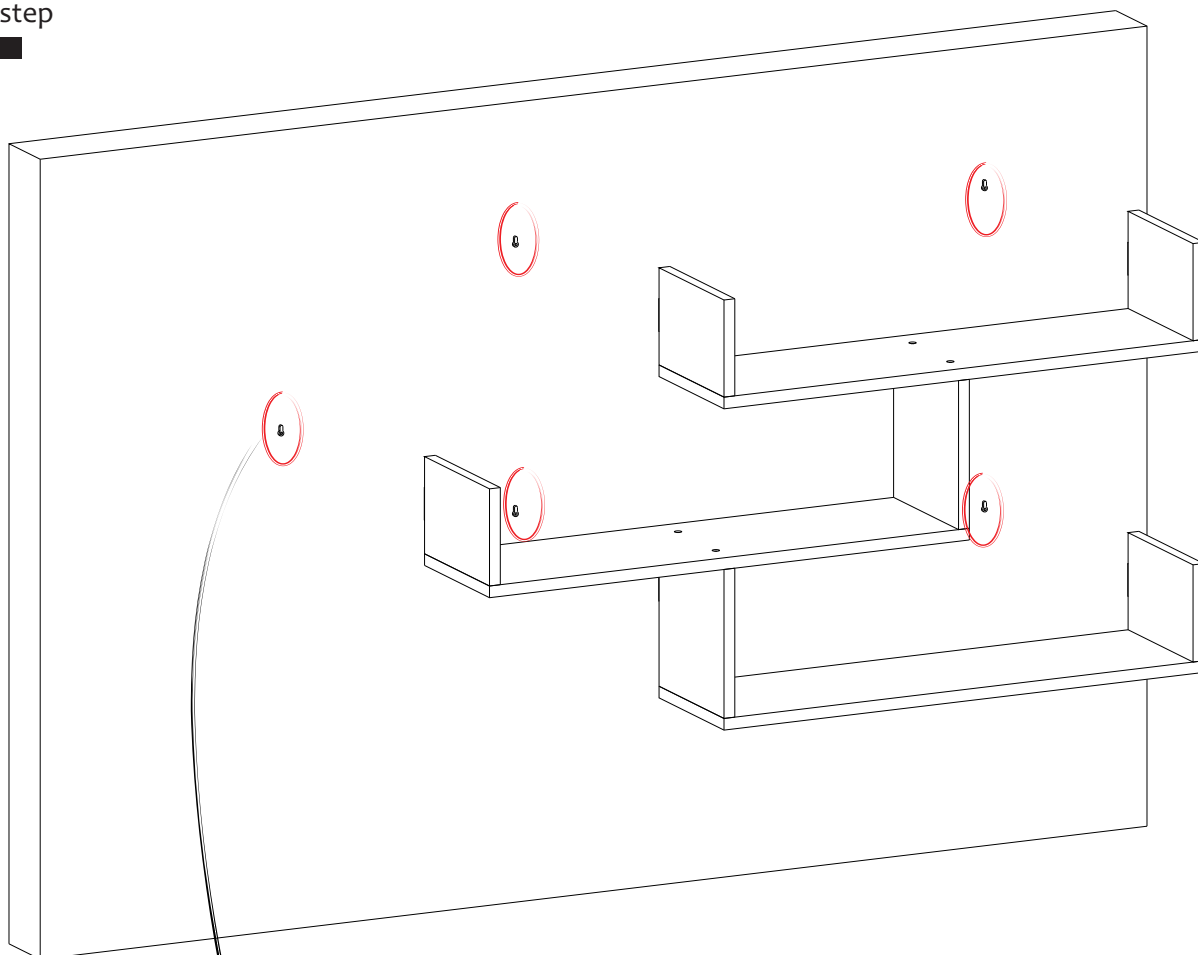

11. step

