

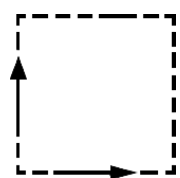

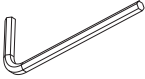

i GP037-0305,2



55 x 25 x 62cm

HARDWARE LIST

A12  Allen 1x	A69  P.D. 6x	B11  10 (black)mm 4x	B13  25 (black)mm 10x	Z279  1x
---	--	--	---	---

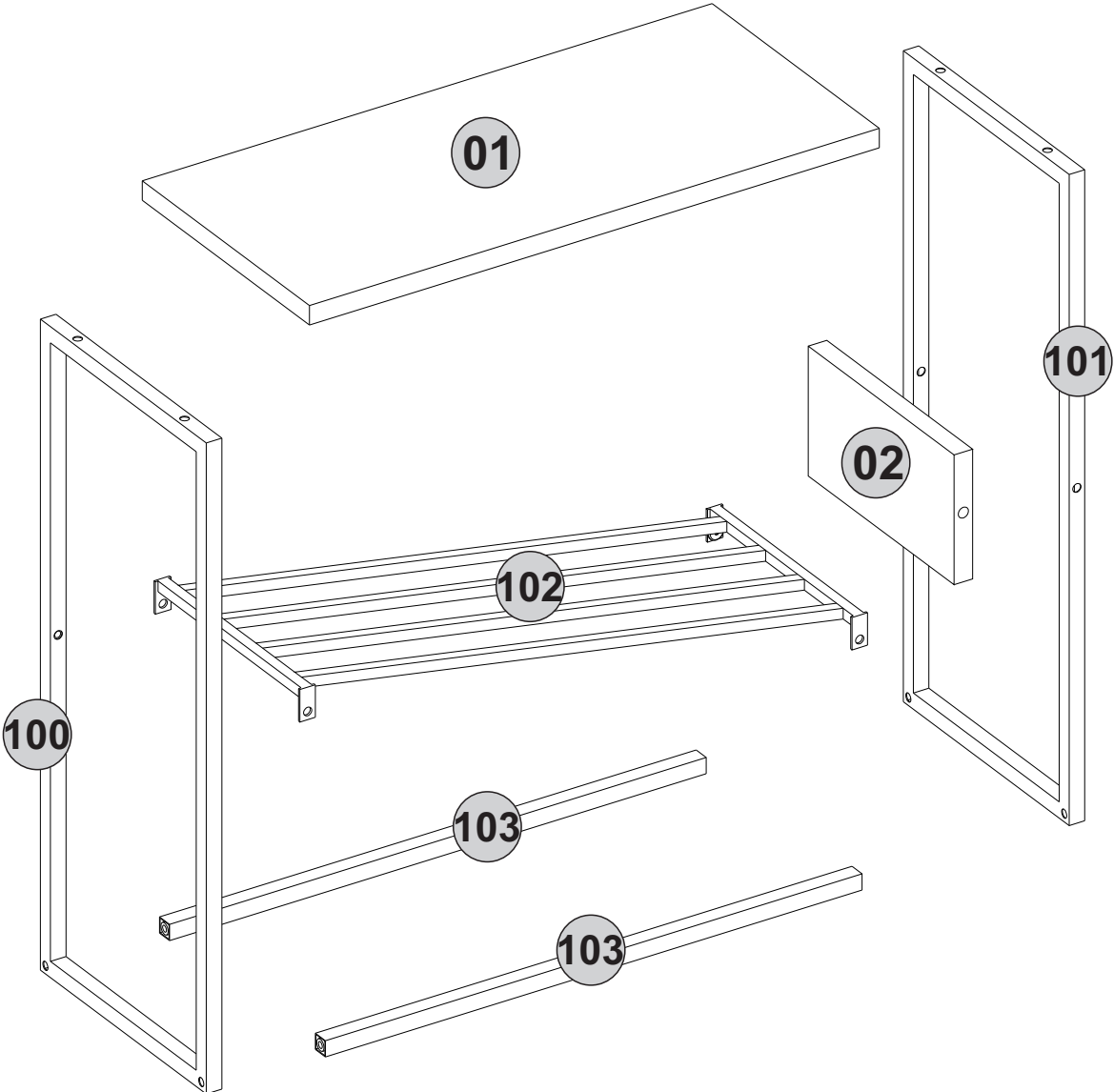

1

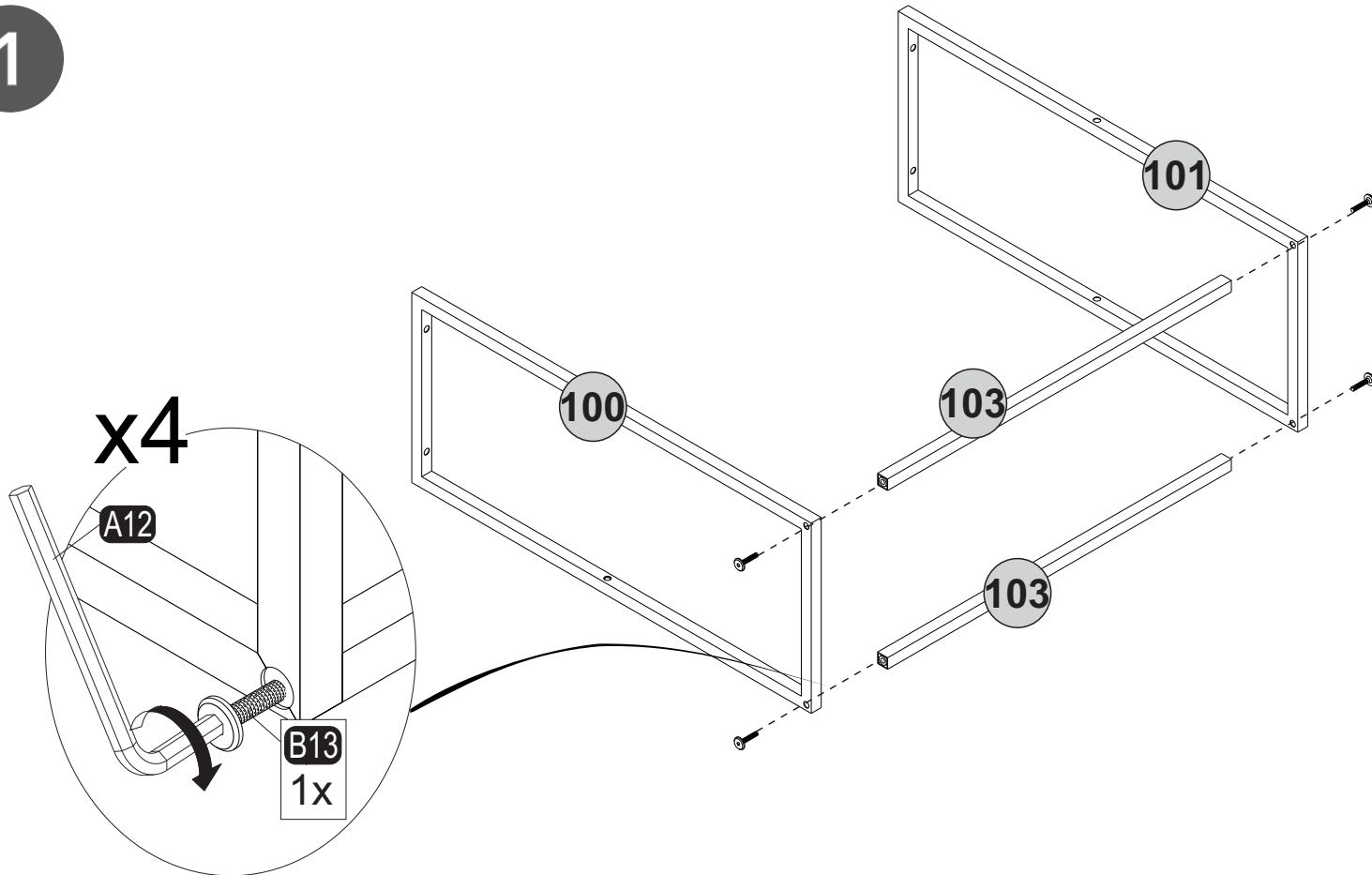

2

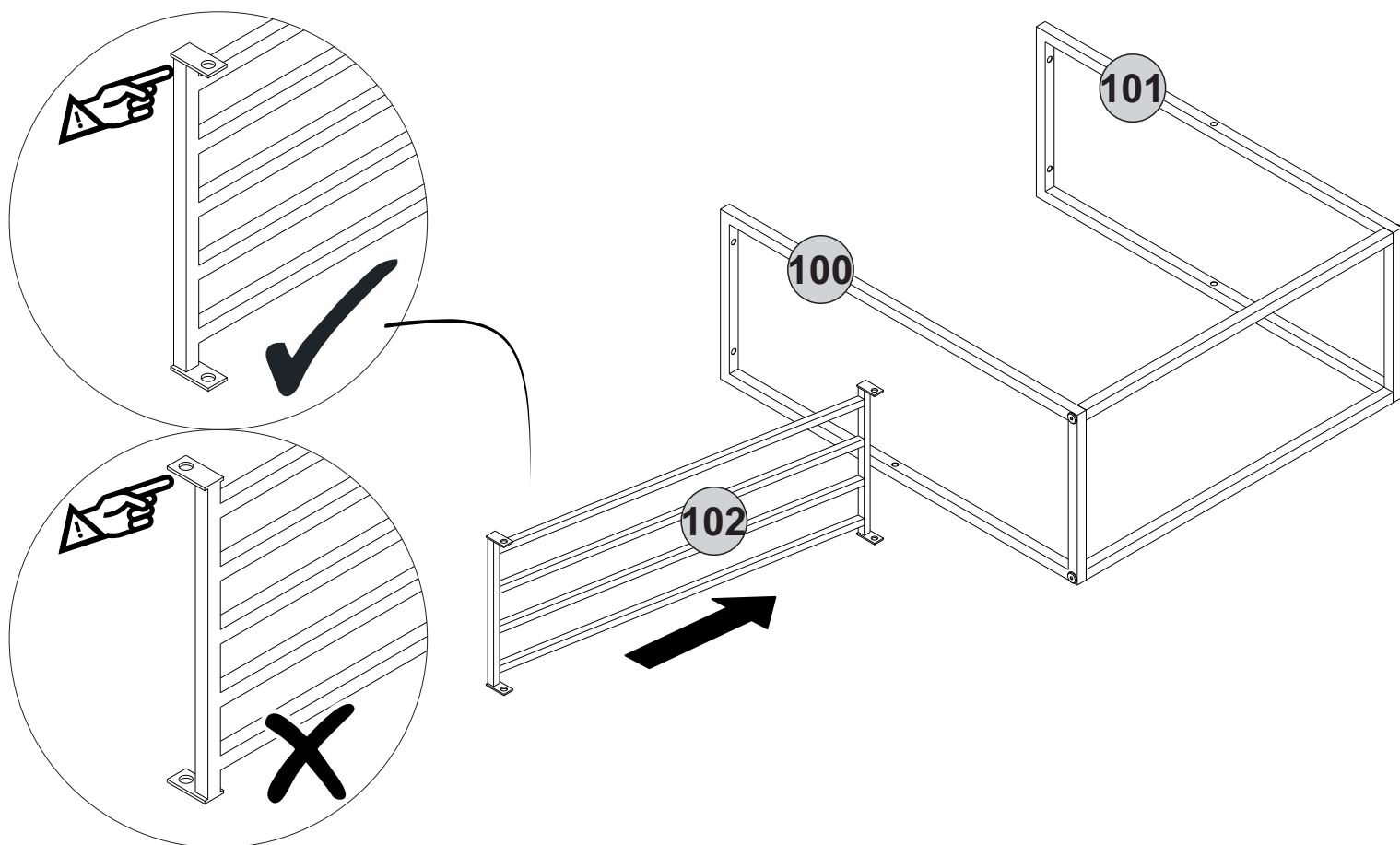

3

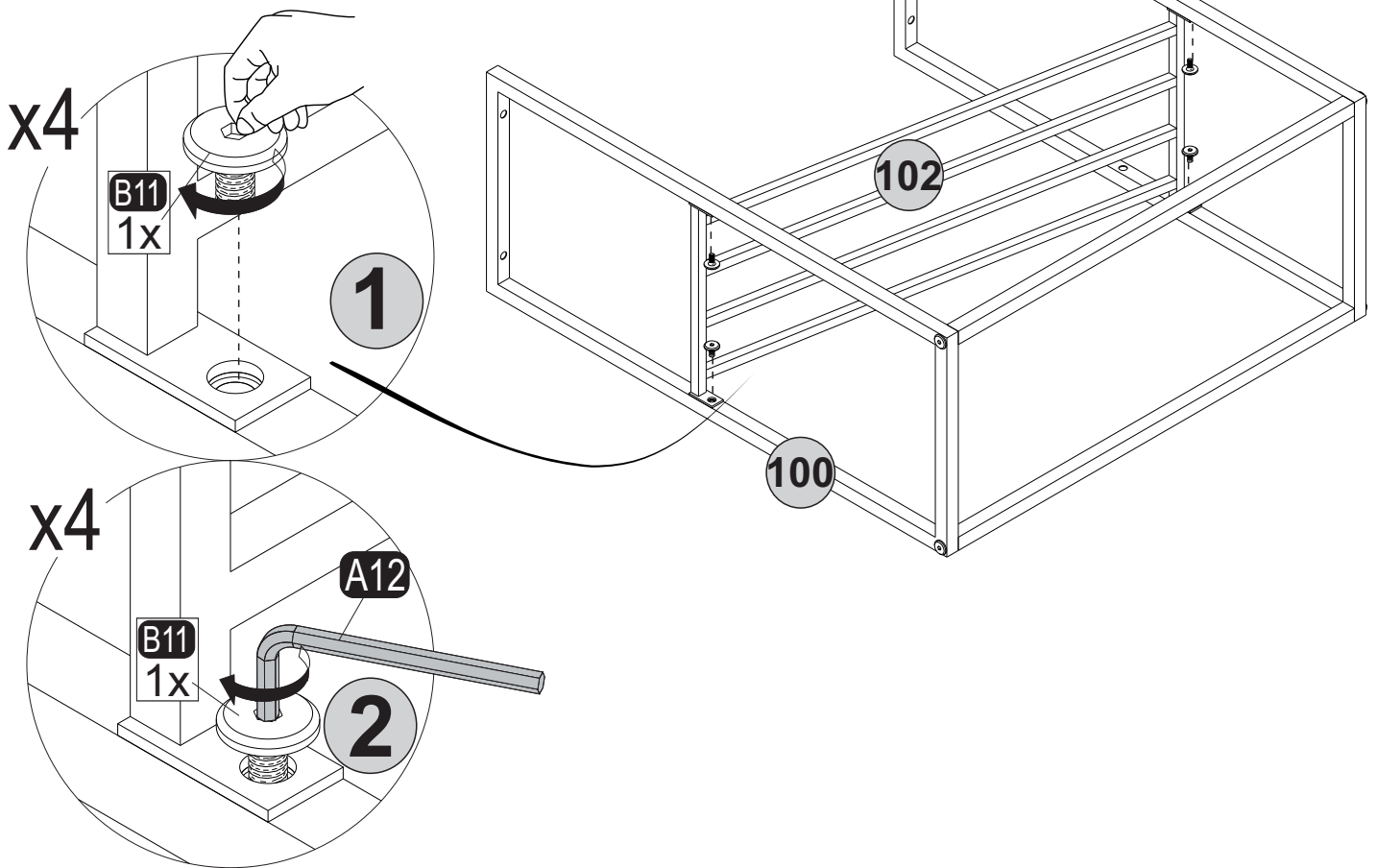

4

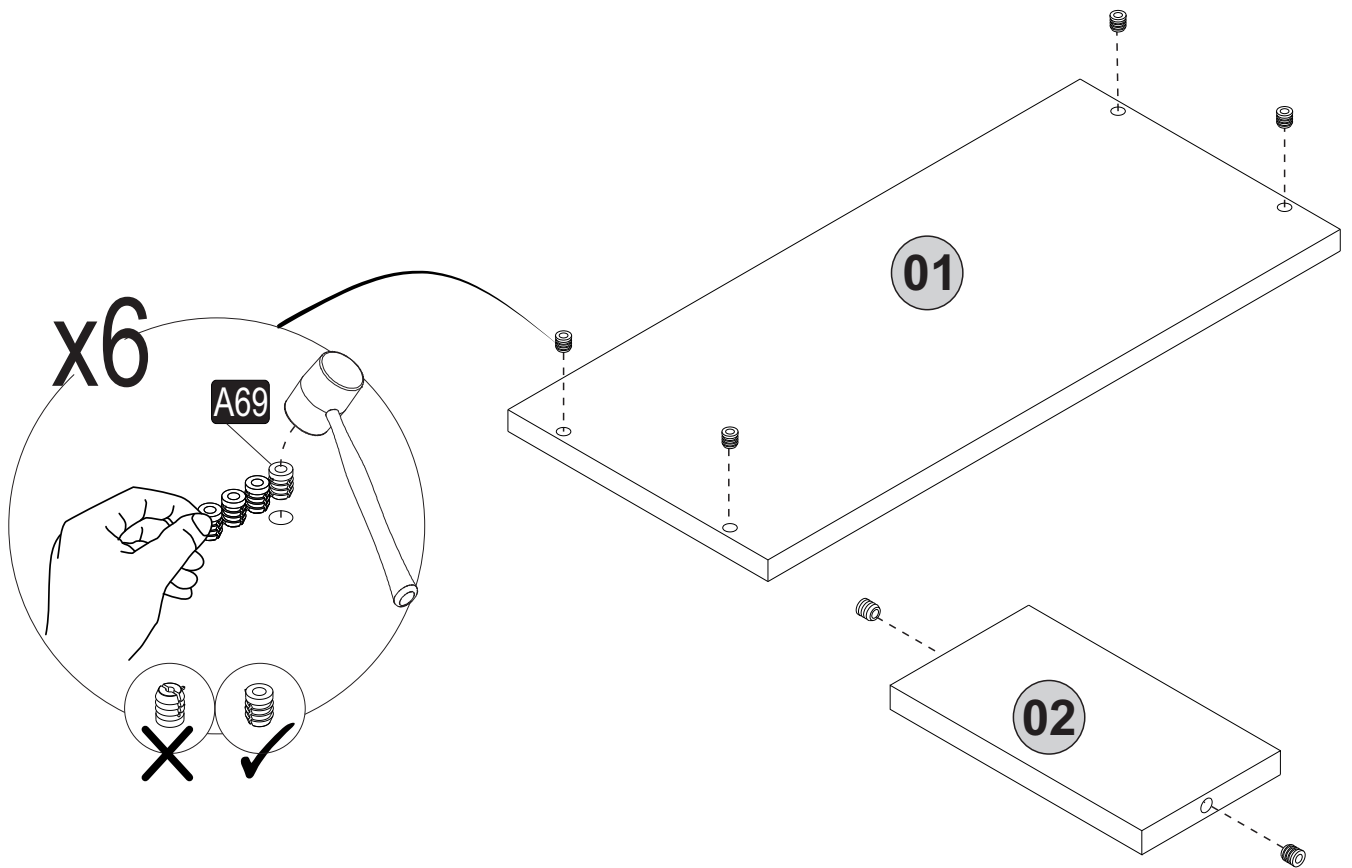

5

x4

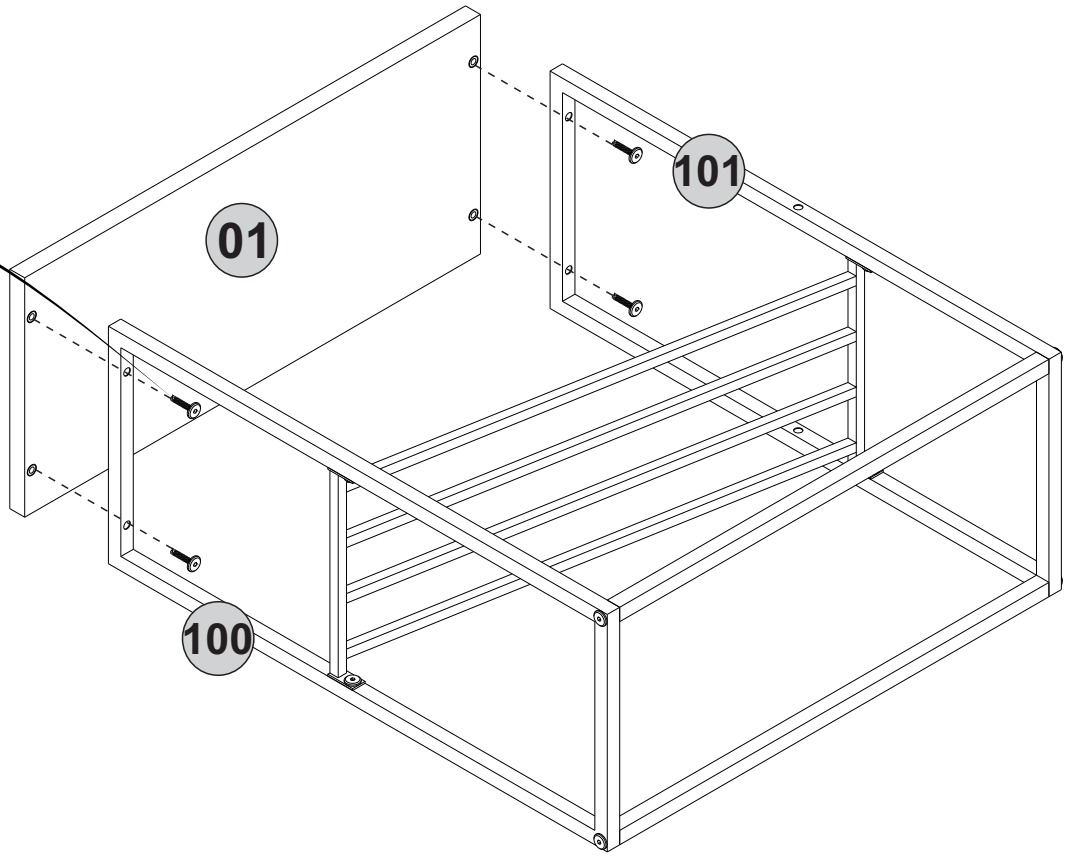
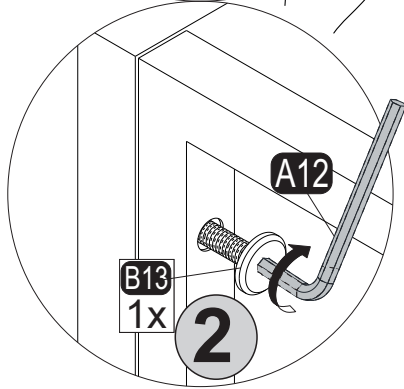
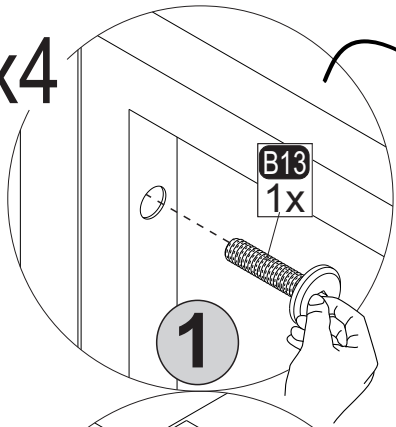

6

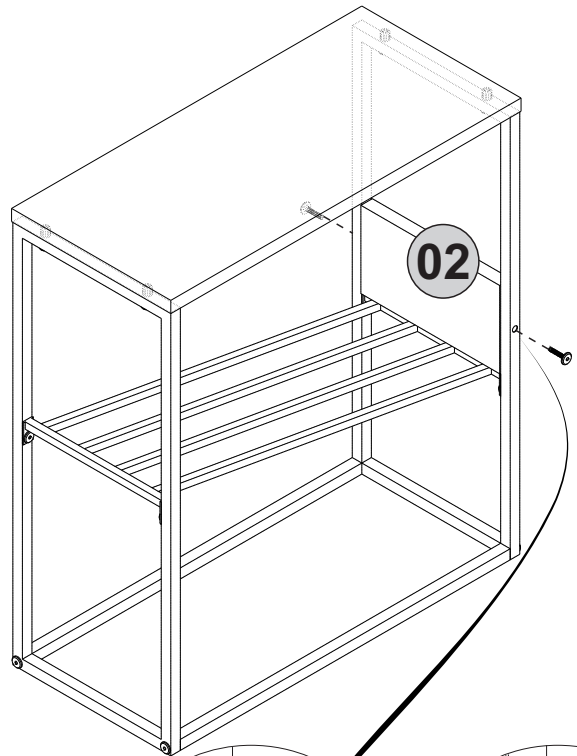
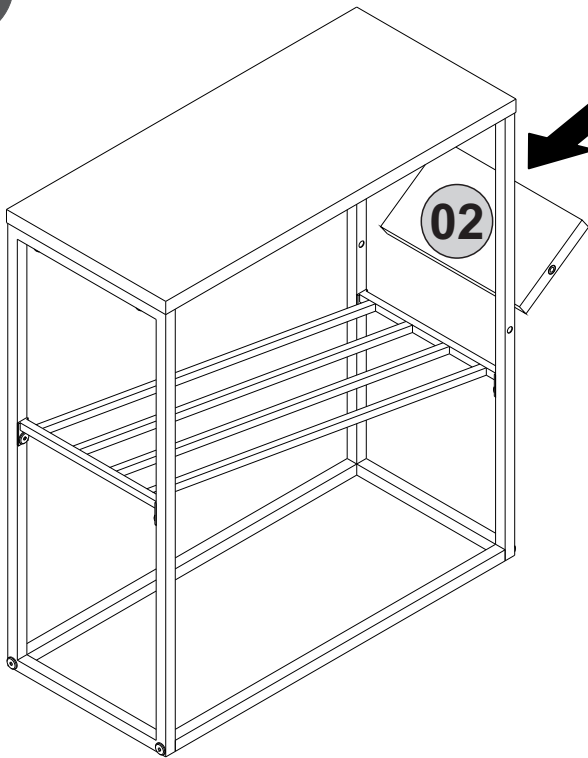

x2

