

GP041-0085,3

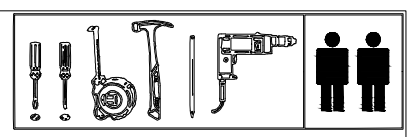







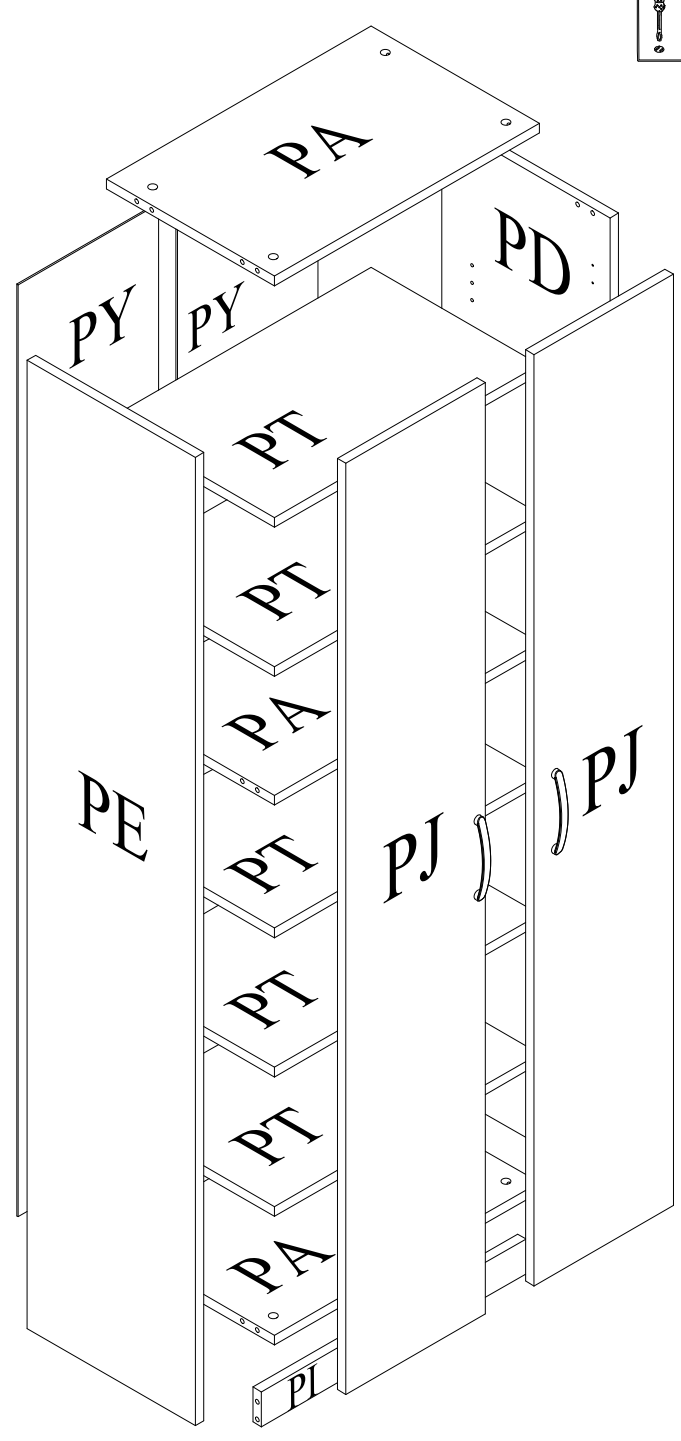

- 1/2
- A**
- PD
- 1X
- PE
- 1X
- PI
- 1X
- PJ
- 1X
- PY
- 2X

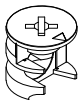
- 2/2
- PA
- 3X
- PT
- 5X

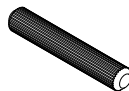

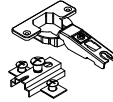
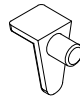
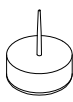
- PA 562x 357 mm
- PD 1779x 357 mm
- PE 1779x 357 mm
- PT 562x 357 mm
- PI 562x 64 mm
- PJ 1711x 296 mm
- PY 1712x 298 mm

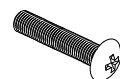

NO:H100023  14 X	NO:H100024  14 X	NO:P000101 Ø8 x 34 MM  14 X	NO:H100002 4x18 YHB MM  16 X	NO:H100039  40 X	NO:H100014  04 X	NO:H100057  20 X	NO:H100069  04 X
NO:H100238  02 X	NO:H100010 M4x21 MM  04 X	NO:H100050 18 MM  08 X					

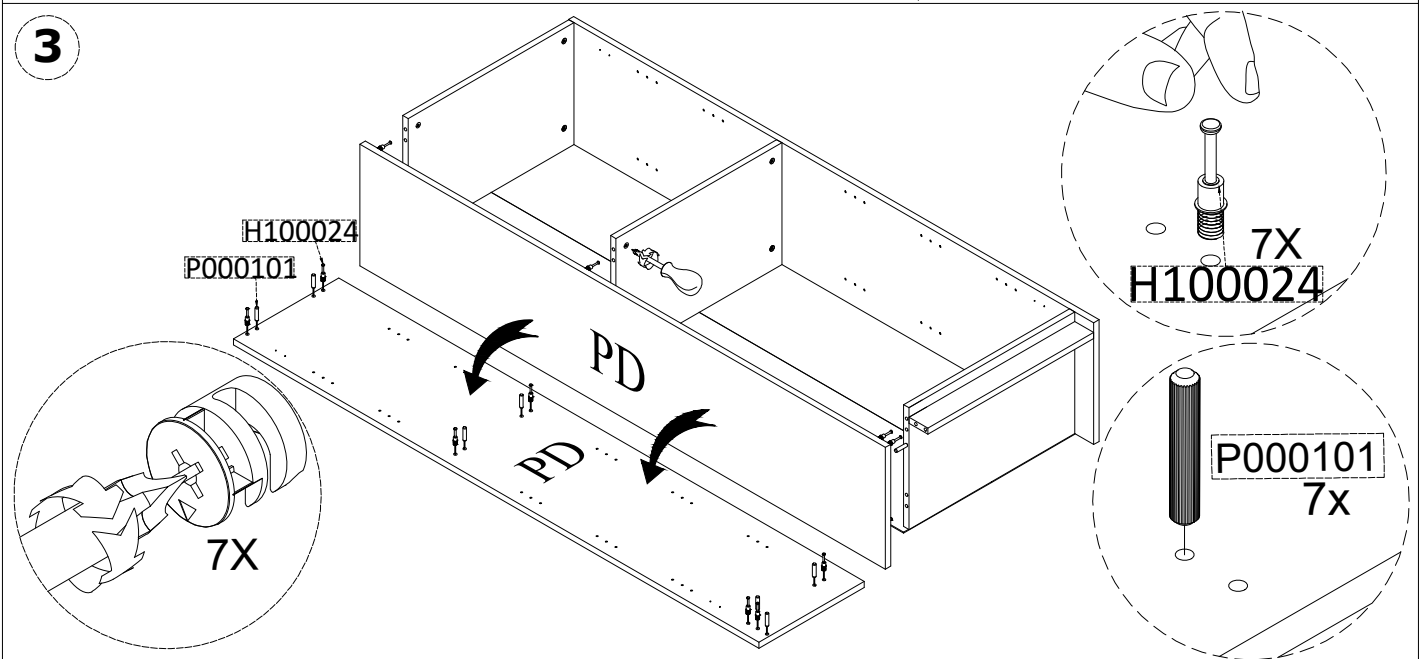
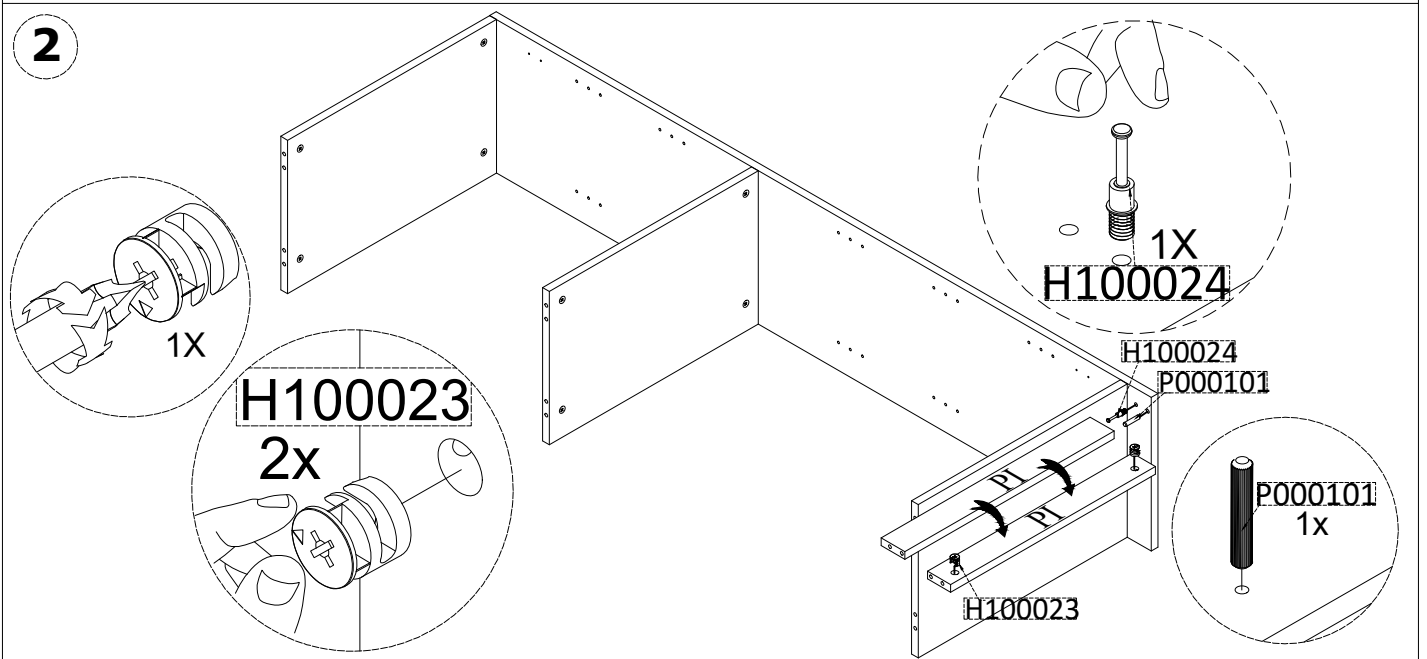
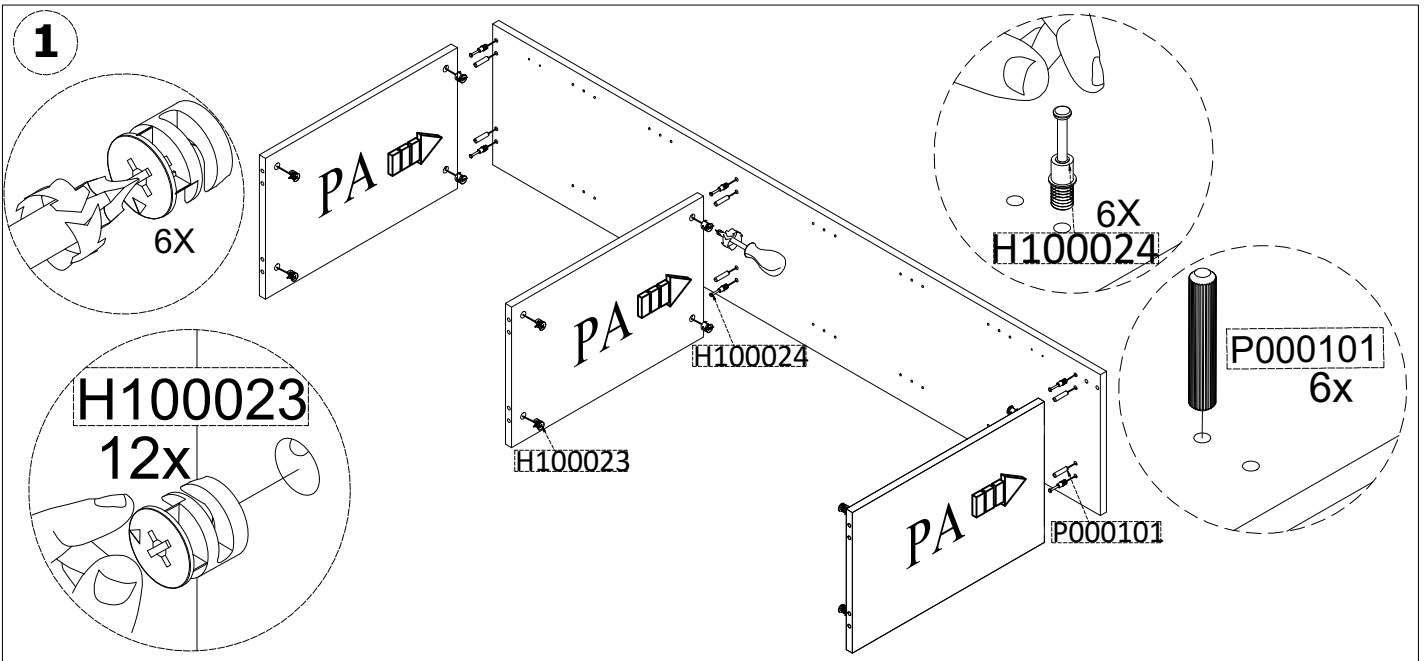

4

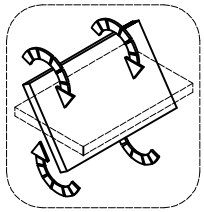
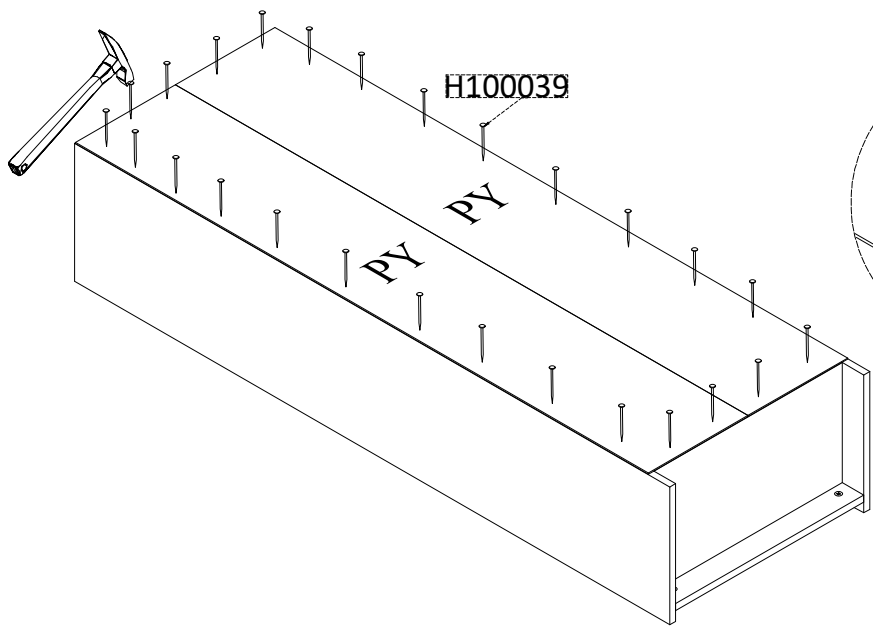

5

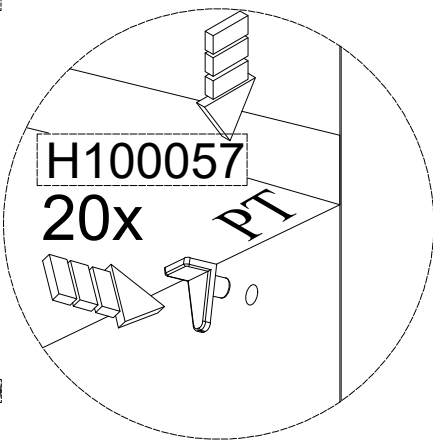
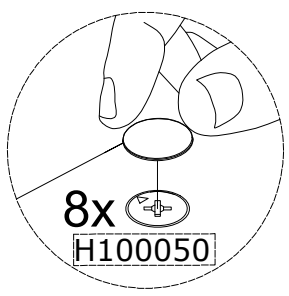
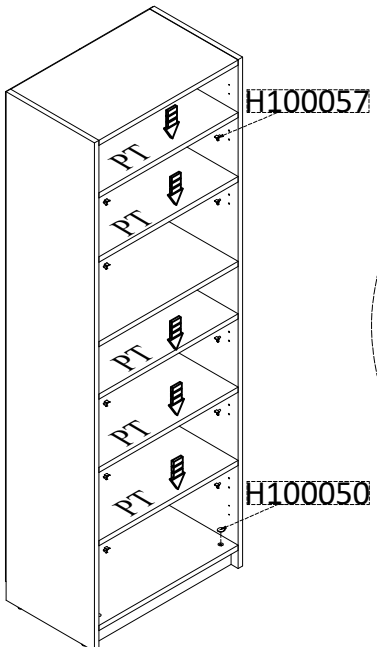

6

