

GP041-0086,2



1/2

A

PA
4X
PT
2X
PY
4X





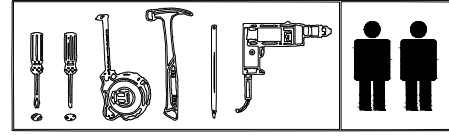

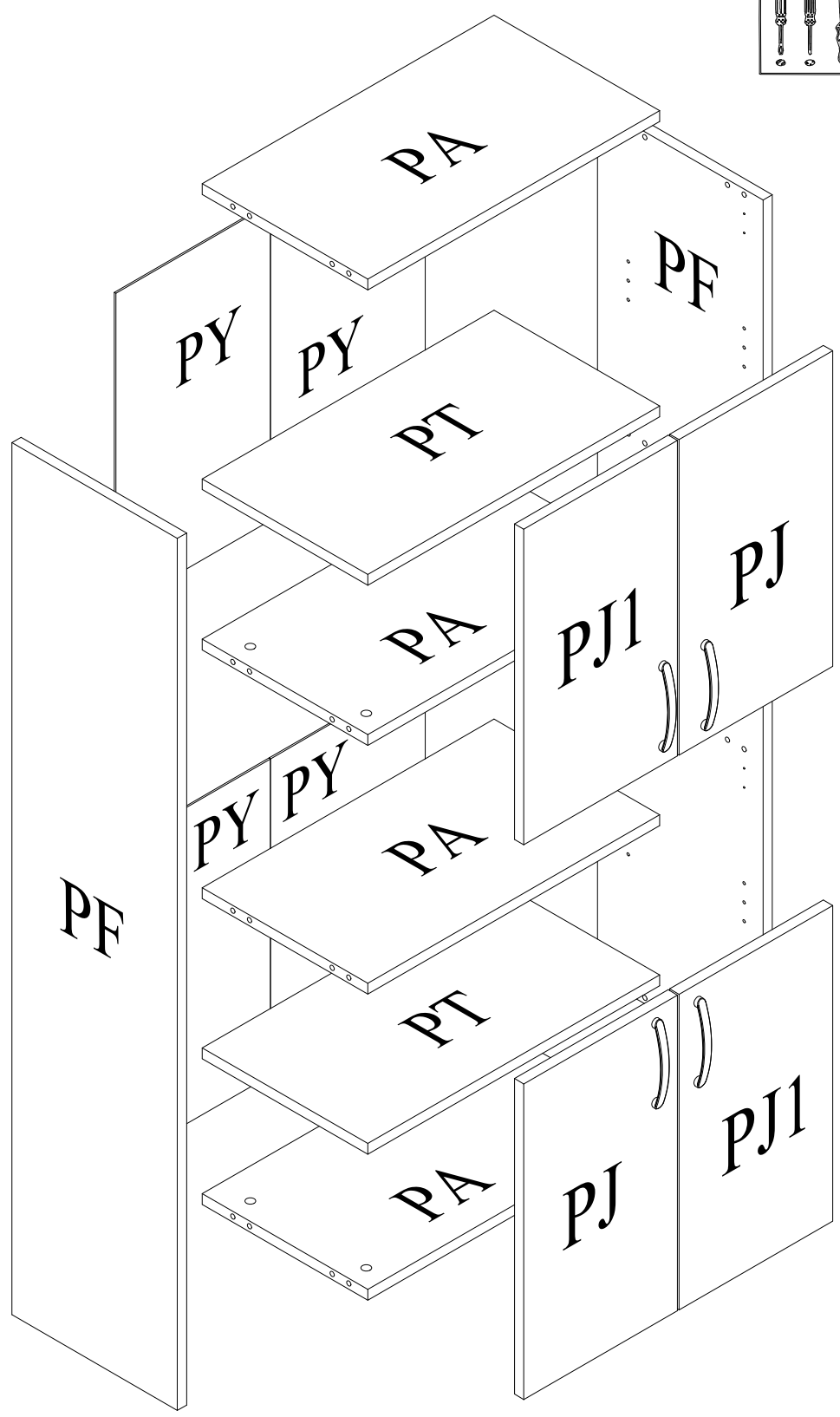

2/2

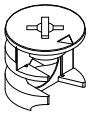
PF
2X
PJ
2X
PJ1
2X

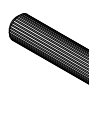
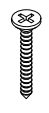

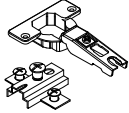
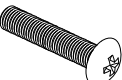
PA 564x 299 mm
PF 1396x 299 mm
PT 564x 299 mm
PJ 464x 297 mm
PJ1 464x 297 mm
PY 465x 299 mm

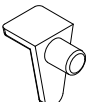
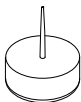

NO:H100023  16 x	NO:H100024  16 x	NO:P000101 Ø8 x 29 MM  16 x	NO:H100002 4x18 MM YHB  32 x	NO:H100039  30 x	NO:H100014  08 x	NO:H100010 M4x21 MM  08 x	NO:H100238 128 MM  04 x
NO:H100057  08 x	NO:H100069  04 X	NO:H100050 18 MM  16 X					

1

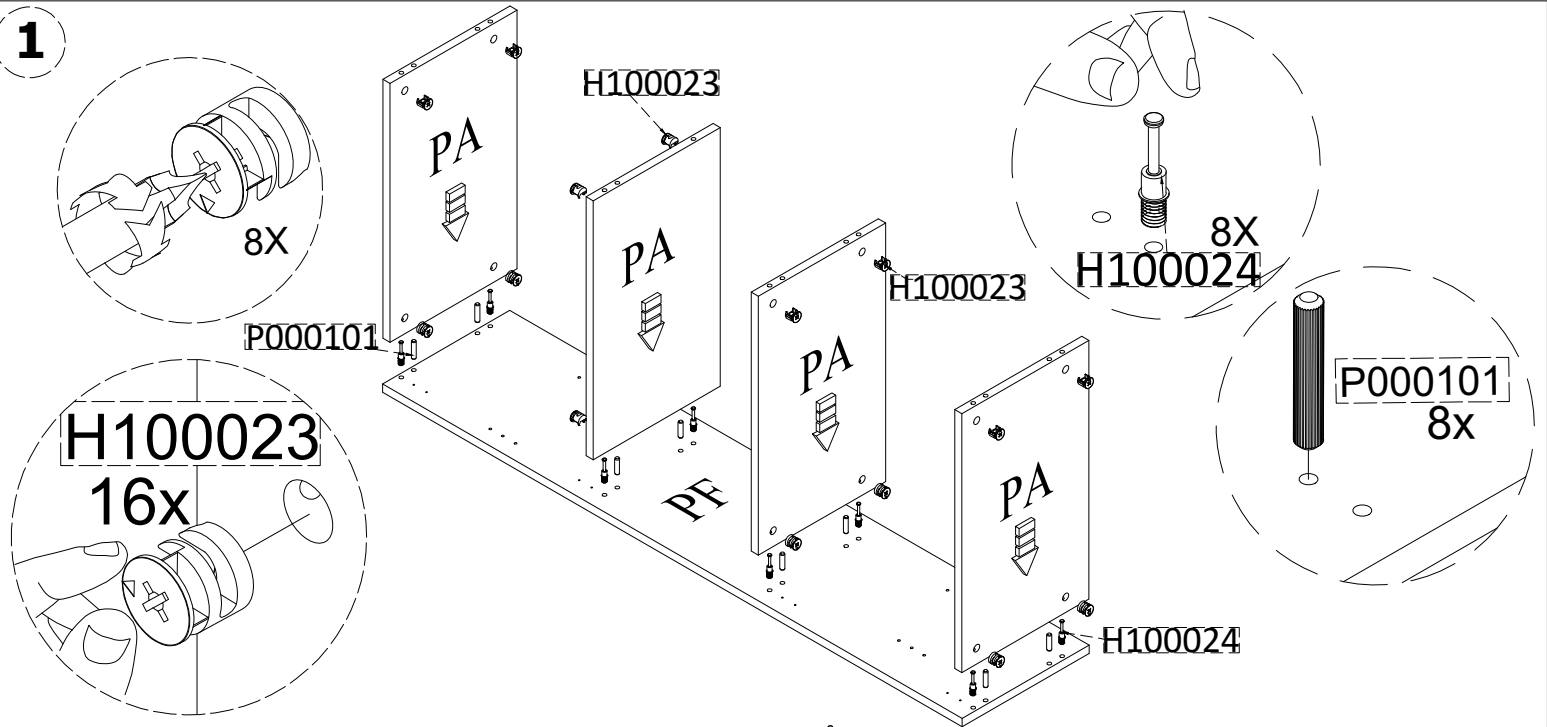

2

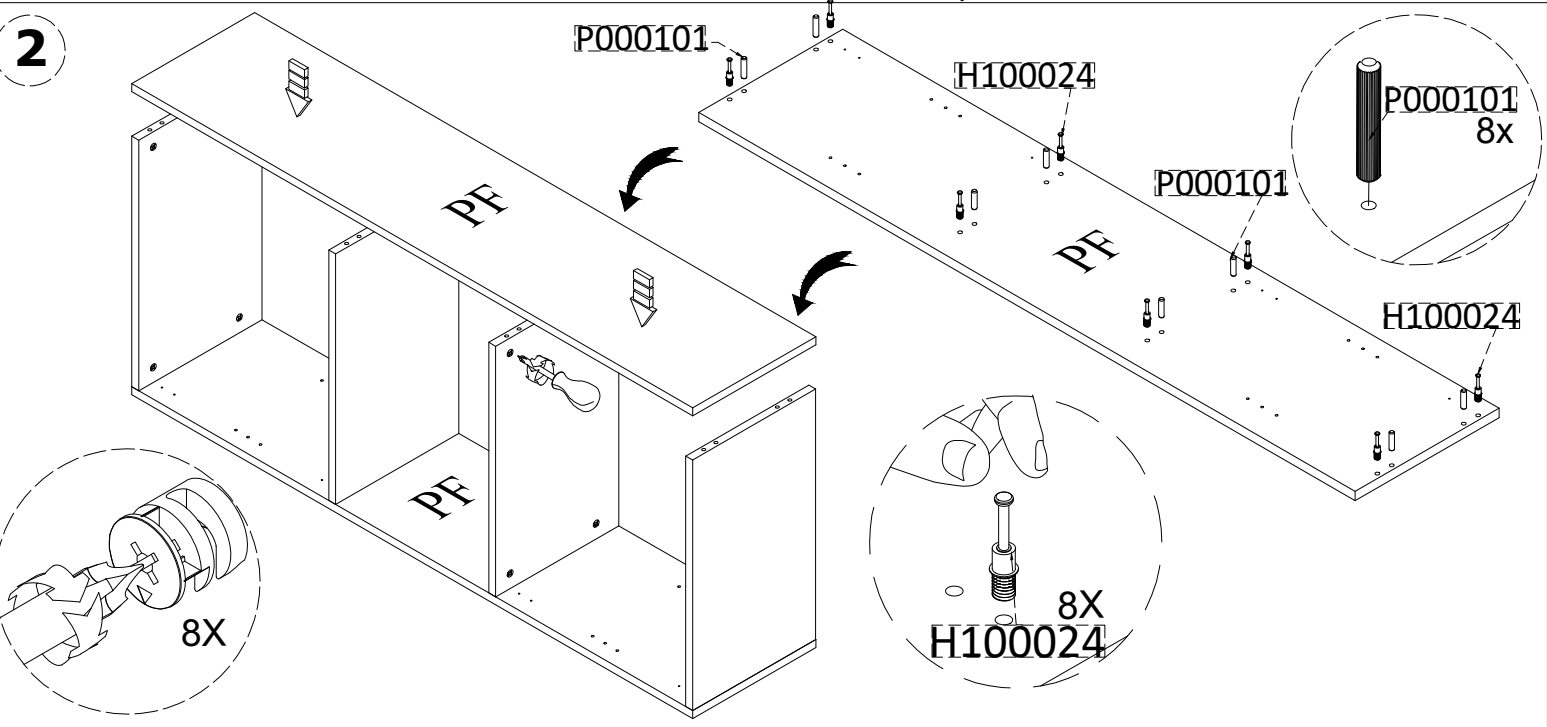

3

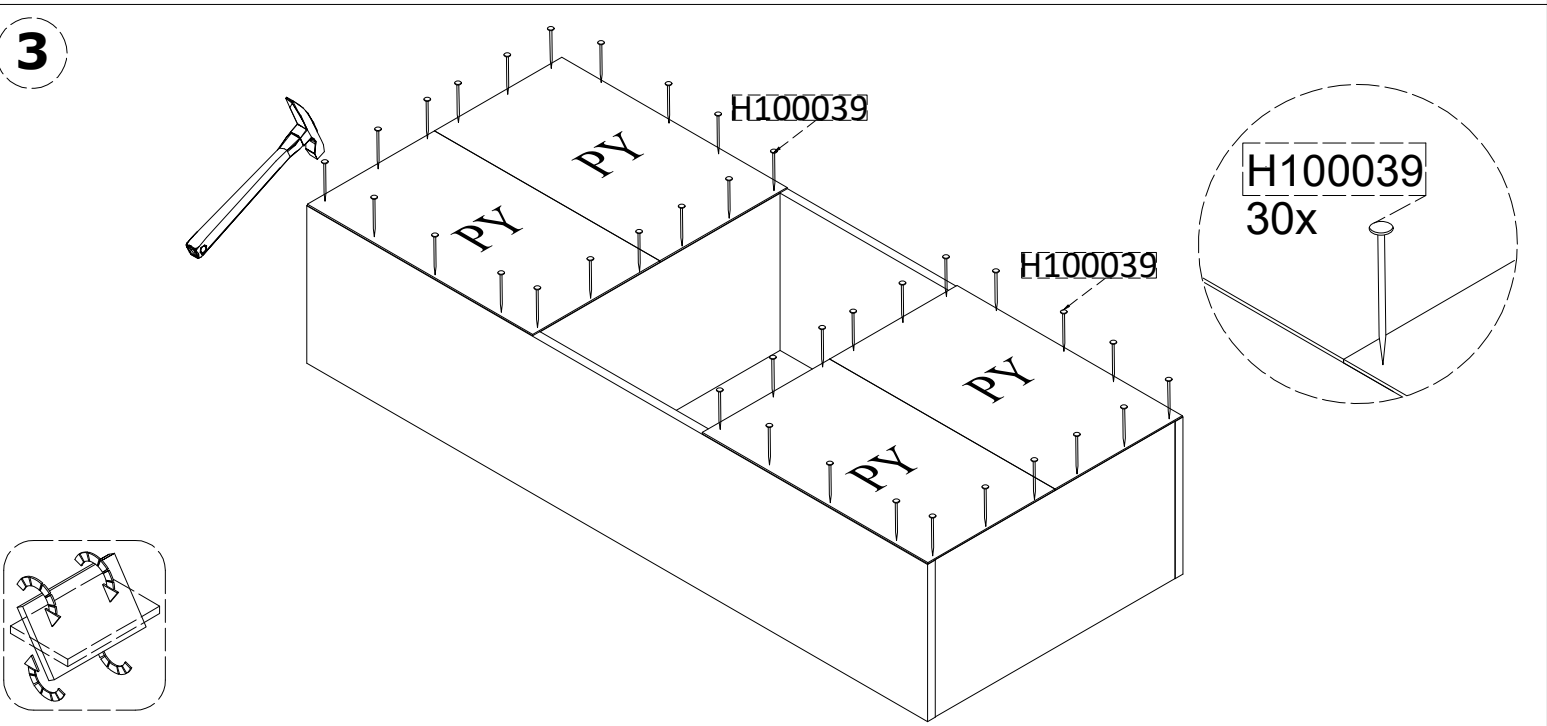

4

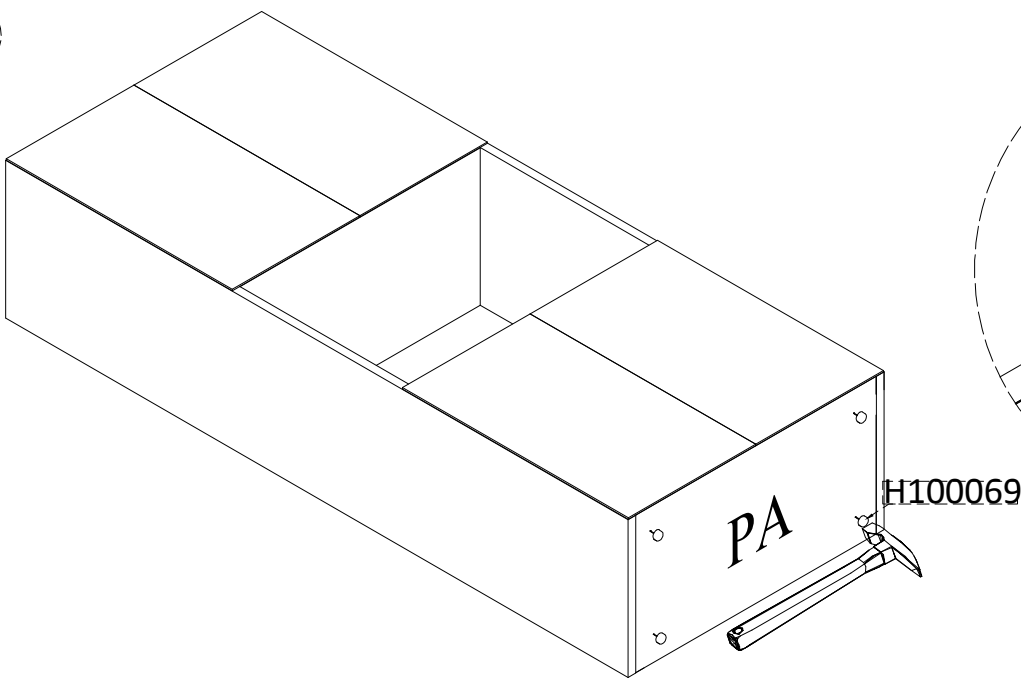

5

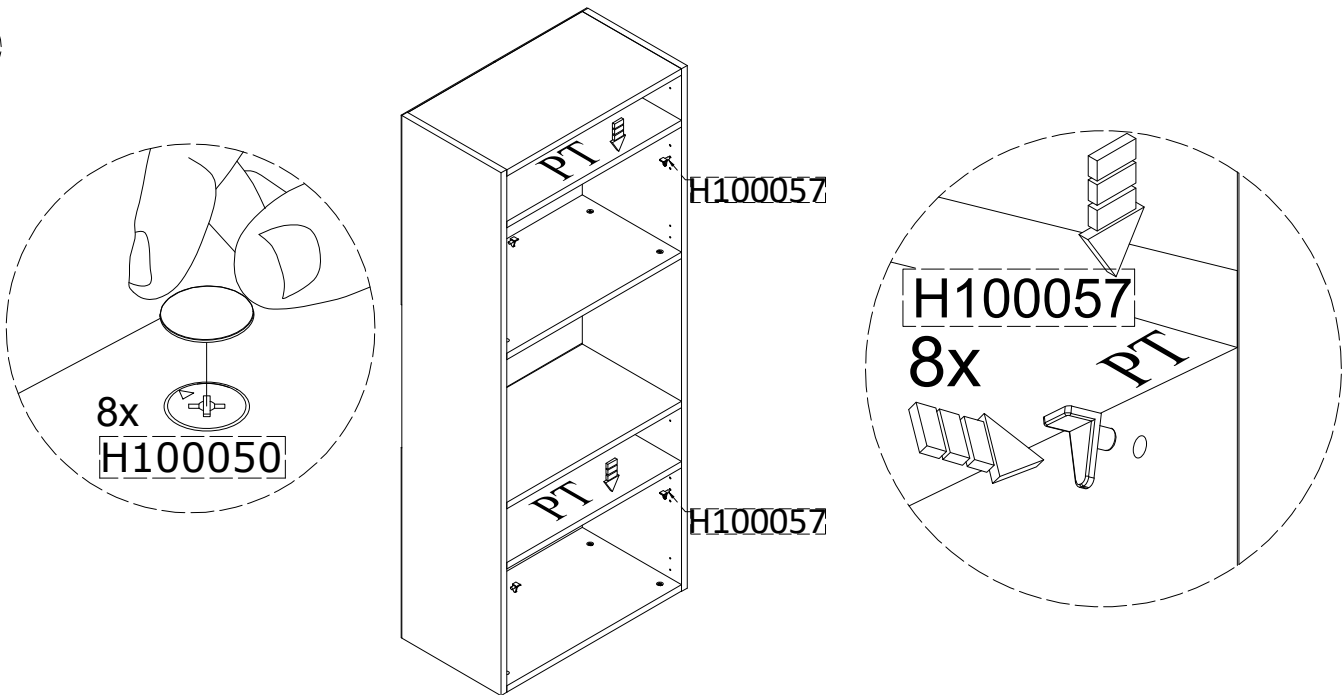

6

