

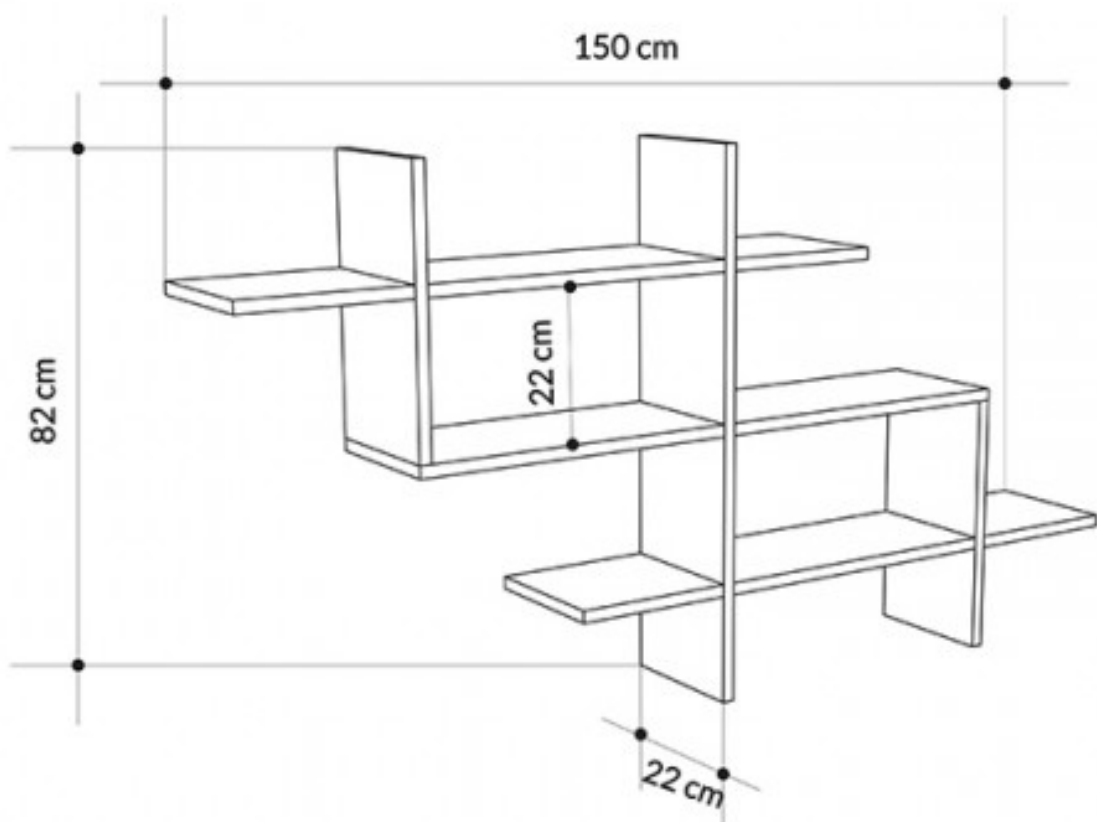

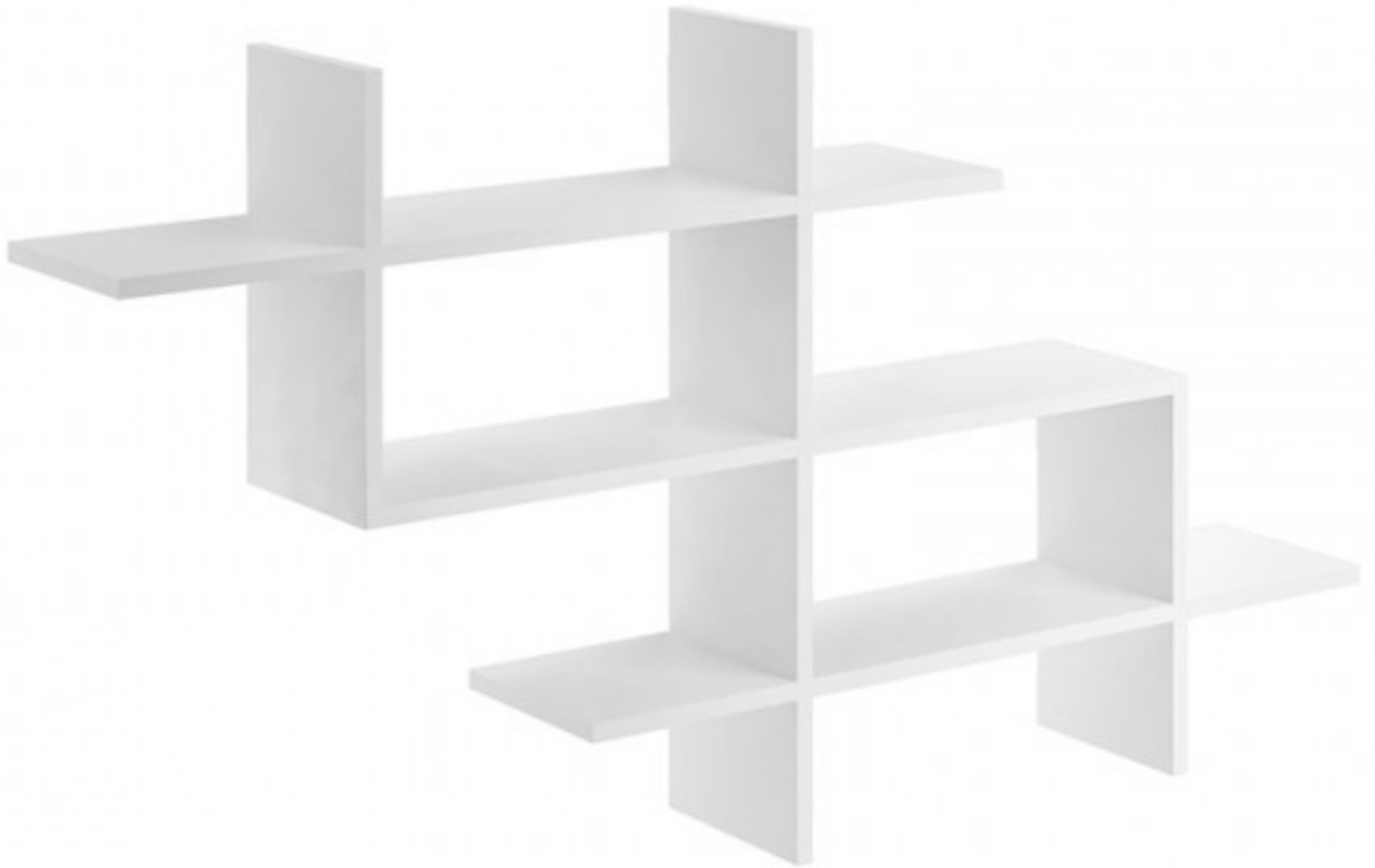





i GP037-0084,5

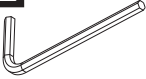
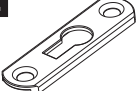

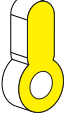
A13  50mm 4x	A12  4 sw 1x	A32  60/16 3x	A11  3,5x30 6x	Z18  Gbdy 3x
A16  DbØ8 3x	A17  4x50 3x	A06  18mm 4x		

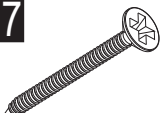

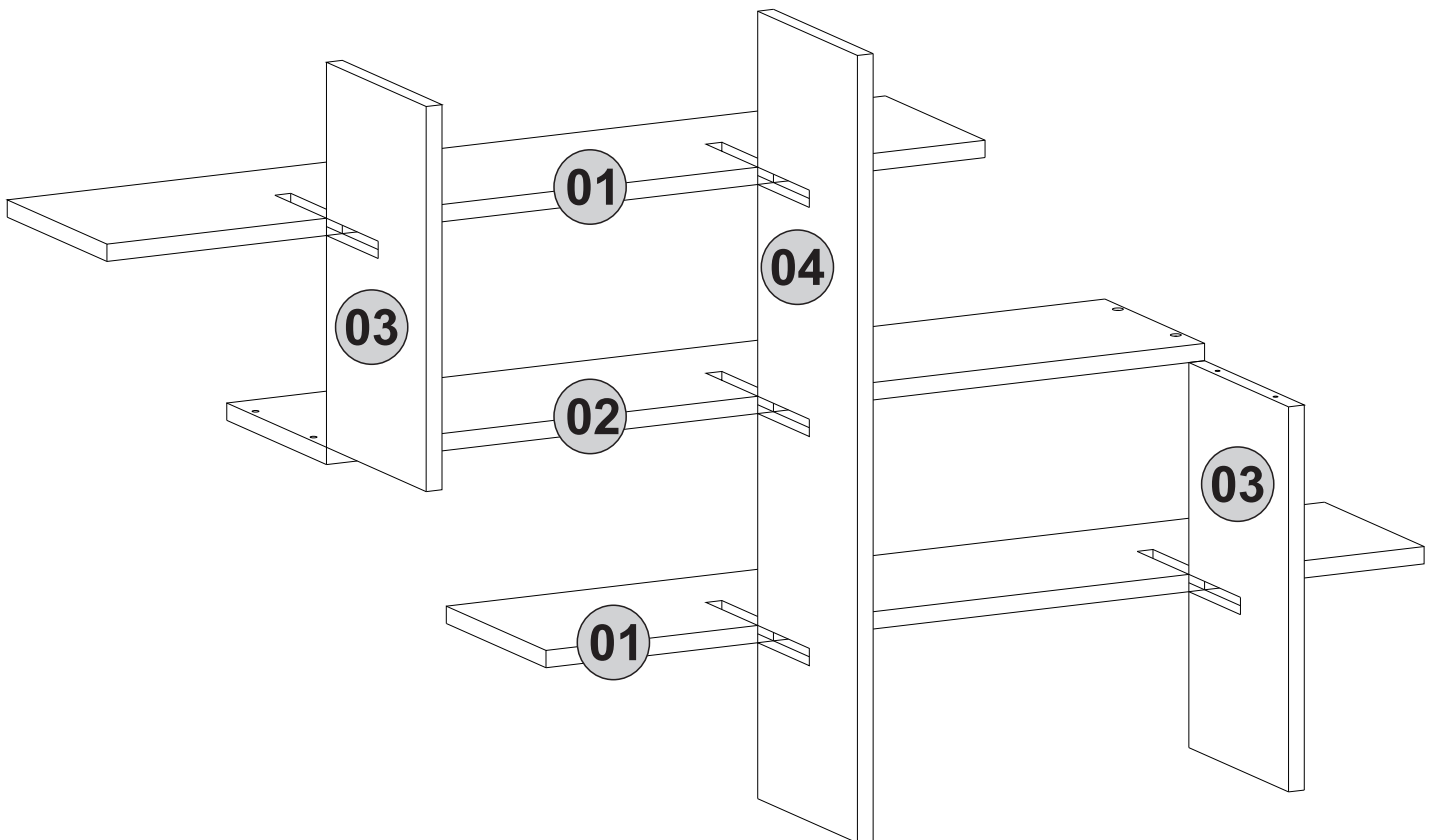
1. step

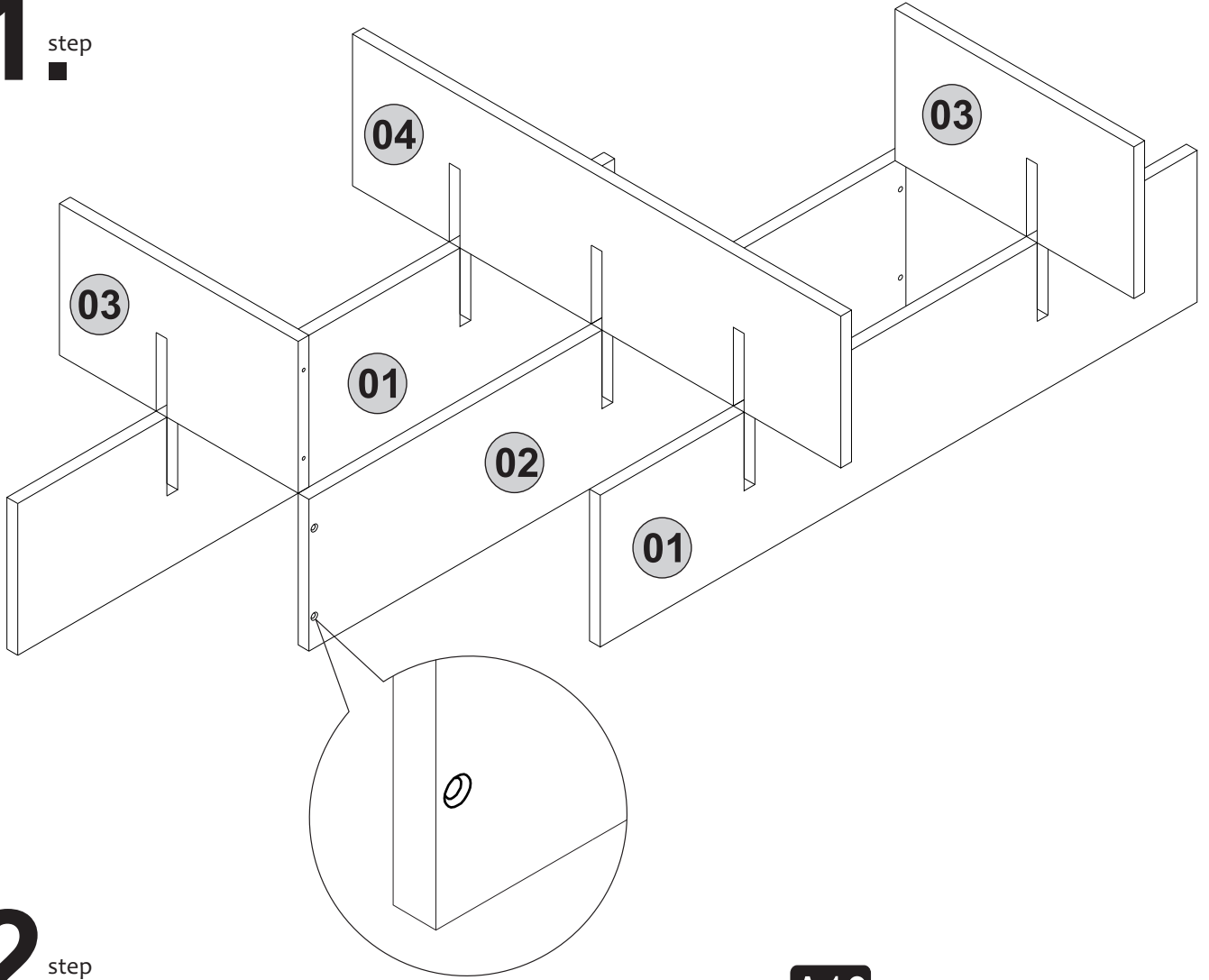

2. step

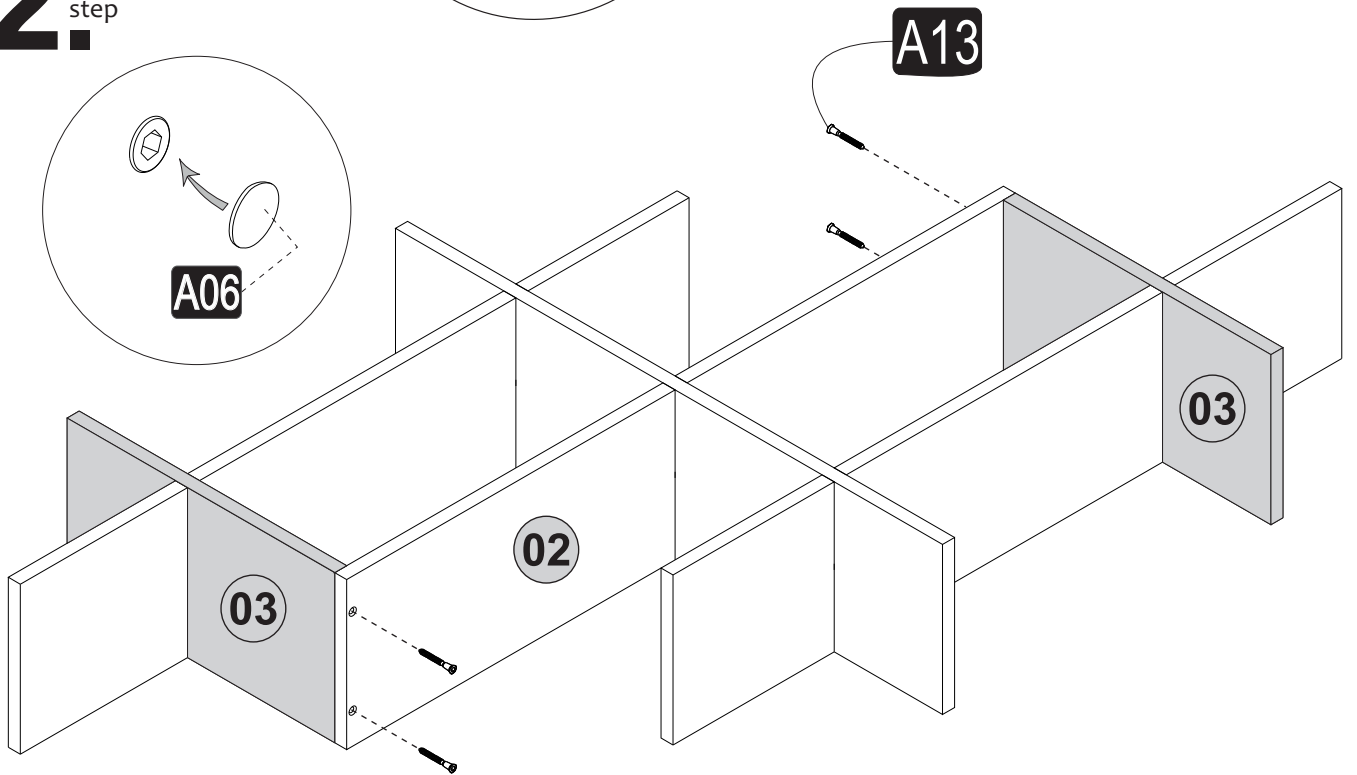

3_{step}

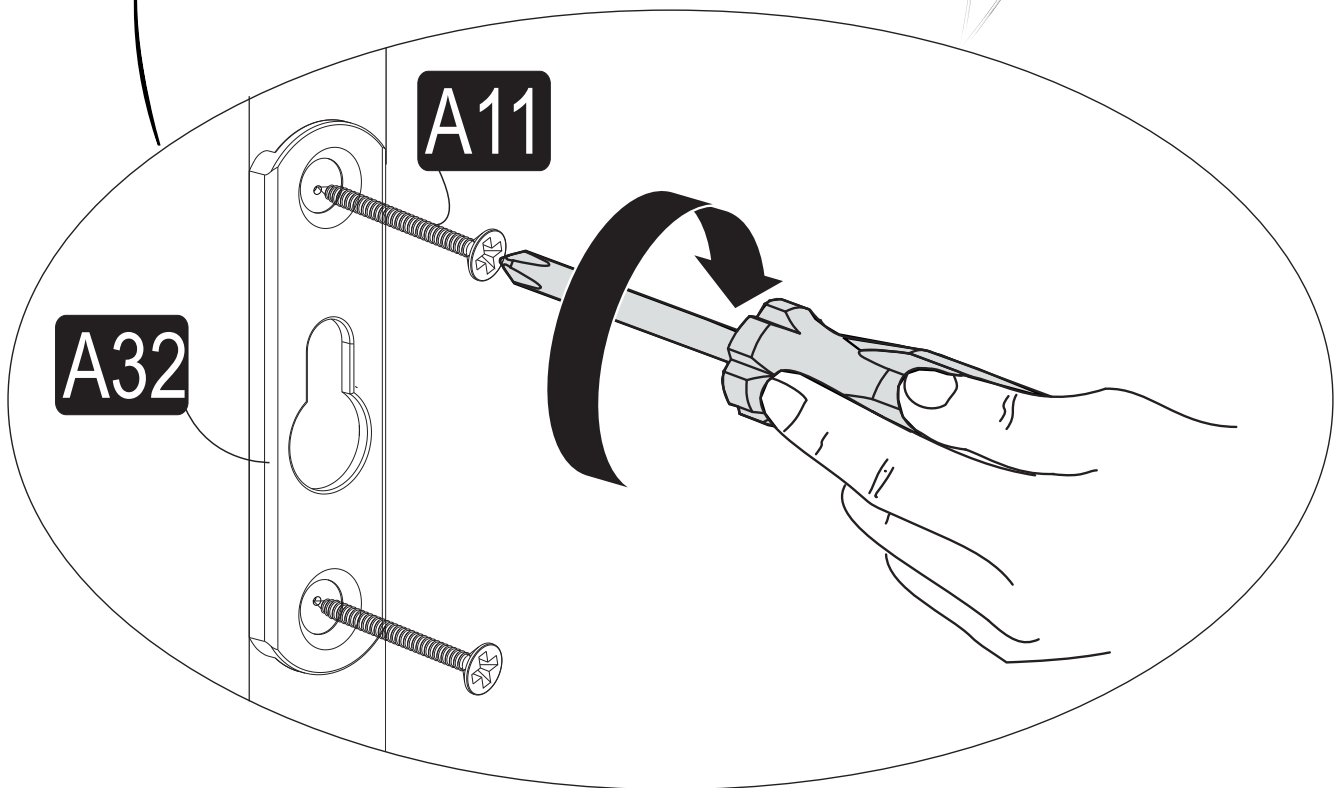
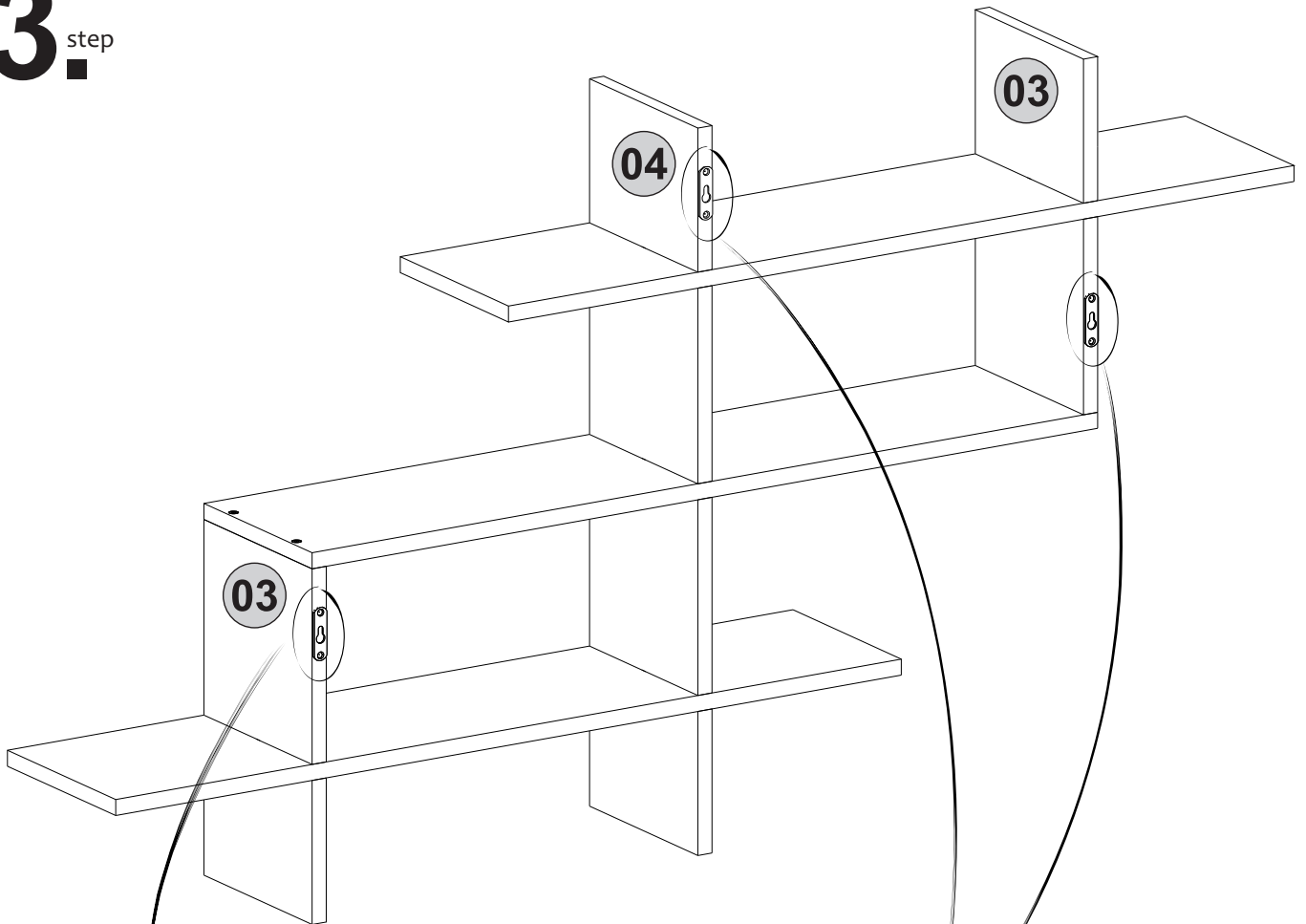

4_{step}

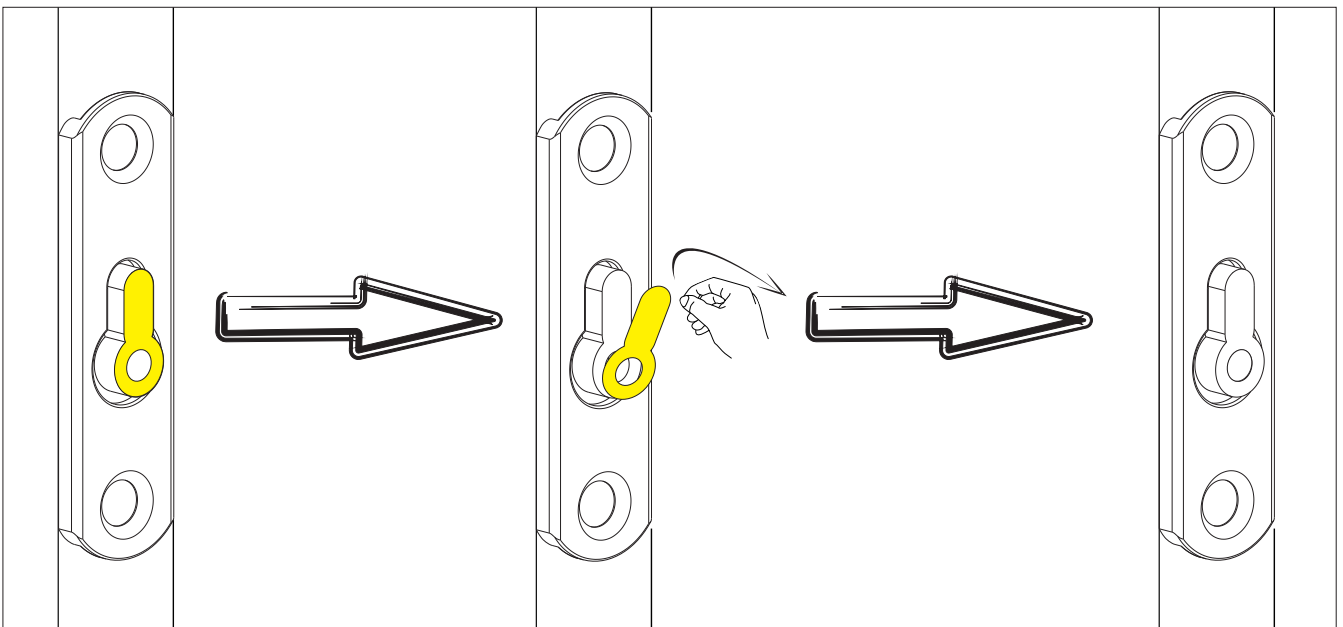
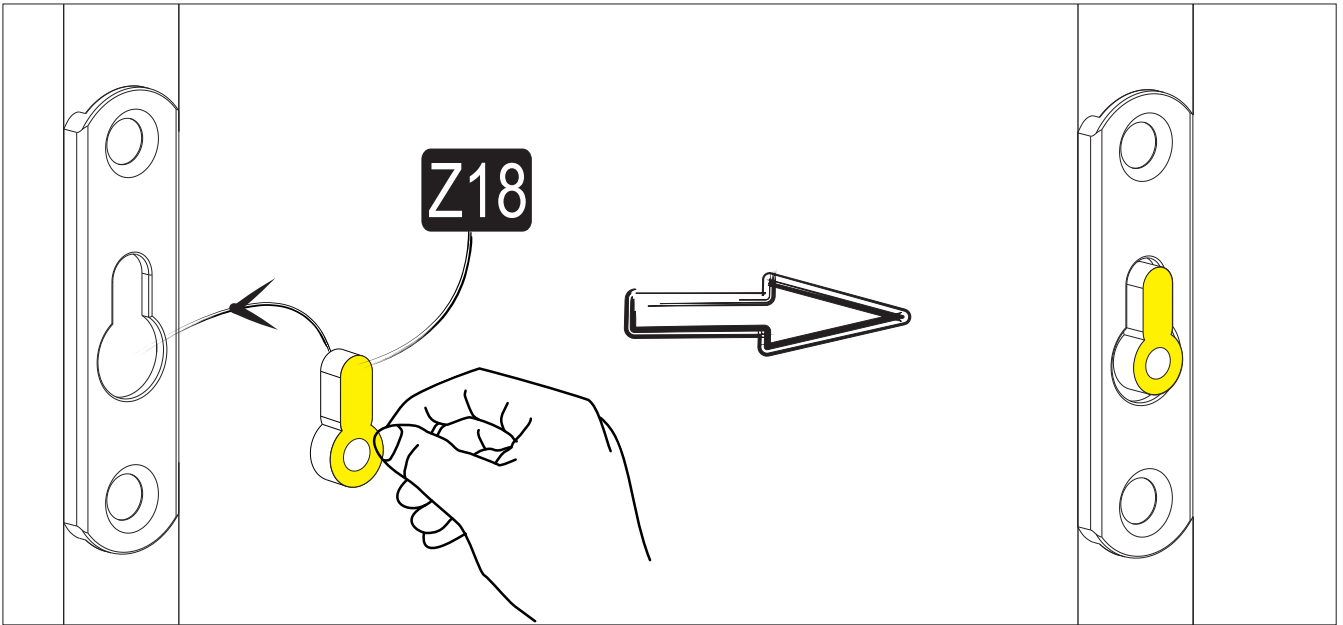

5^{step}

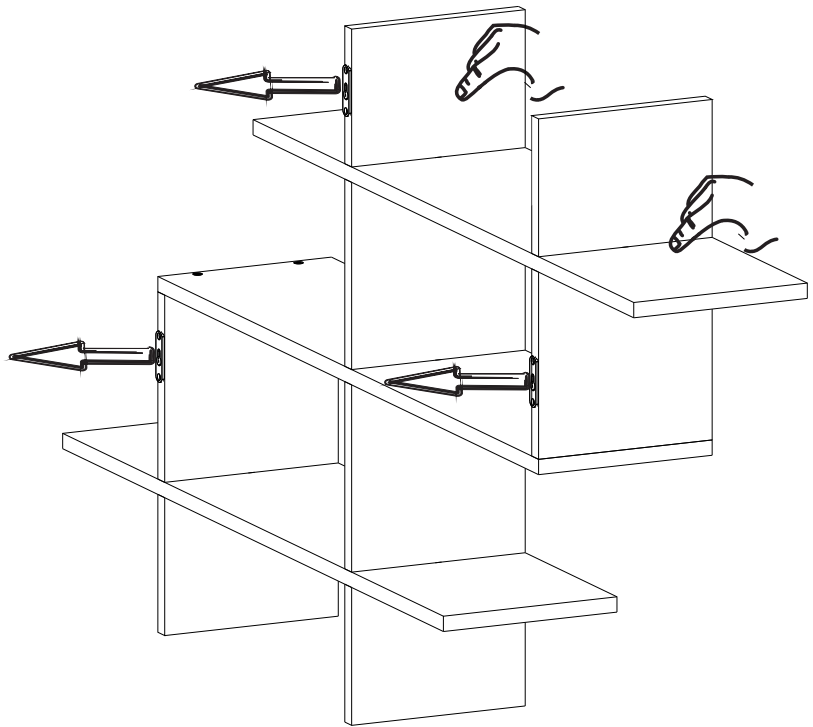
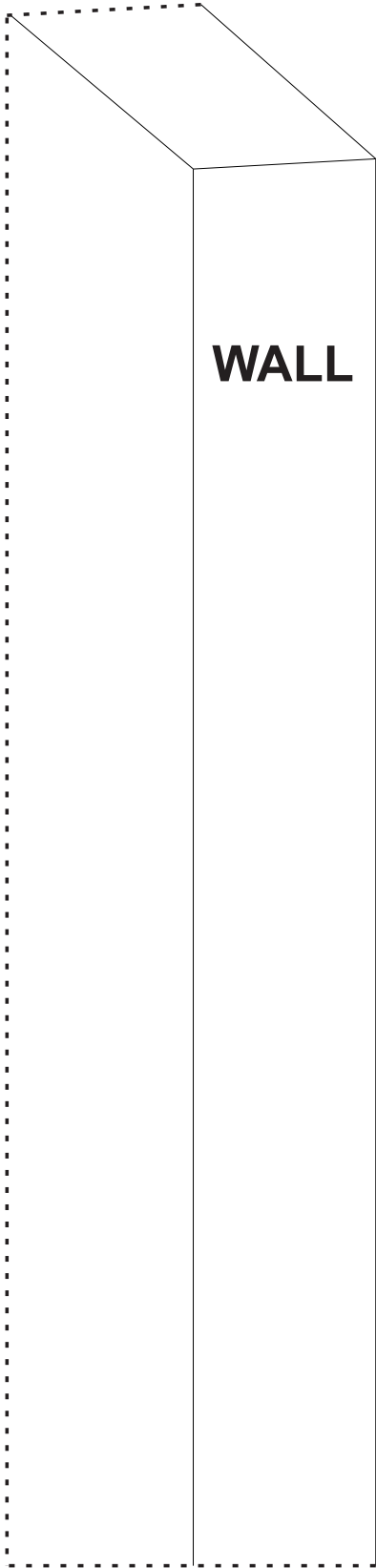

6^{step}

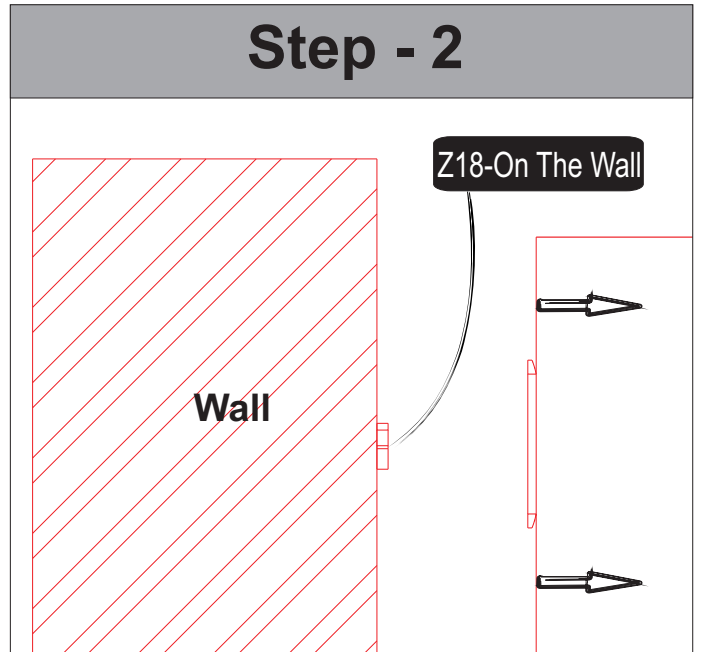
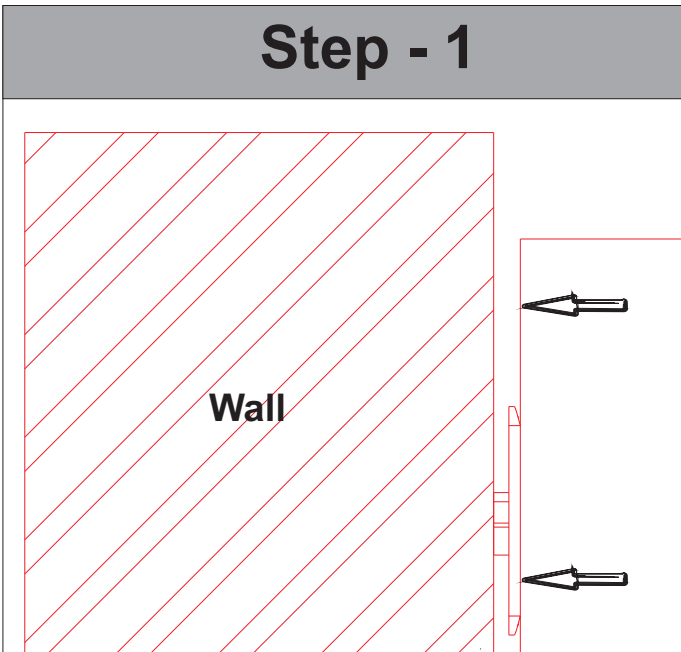
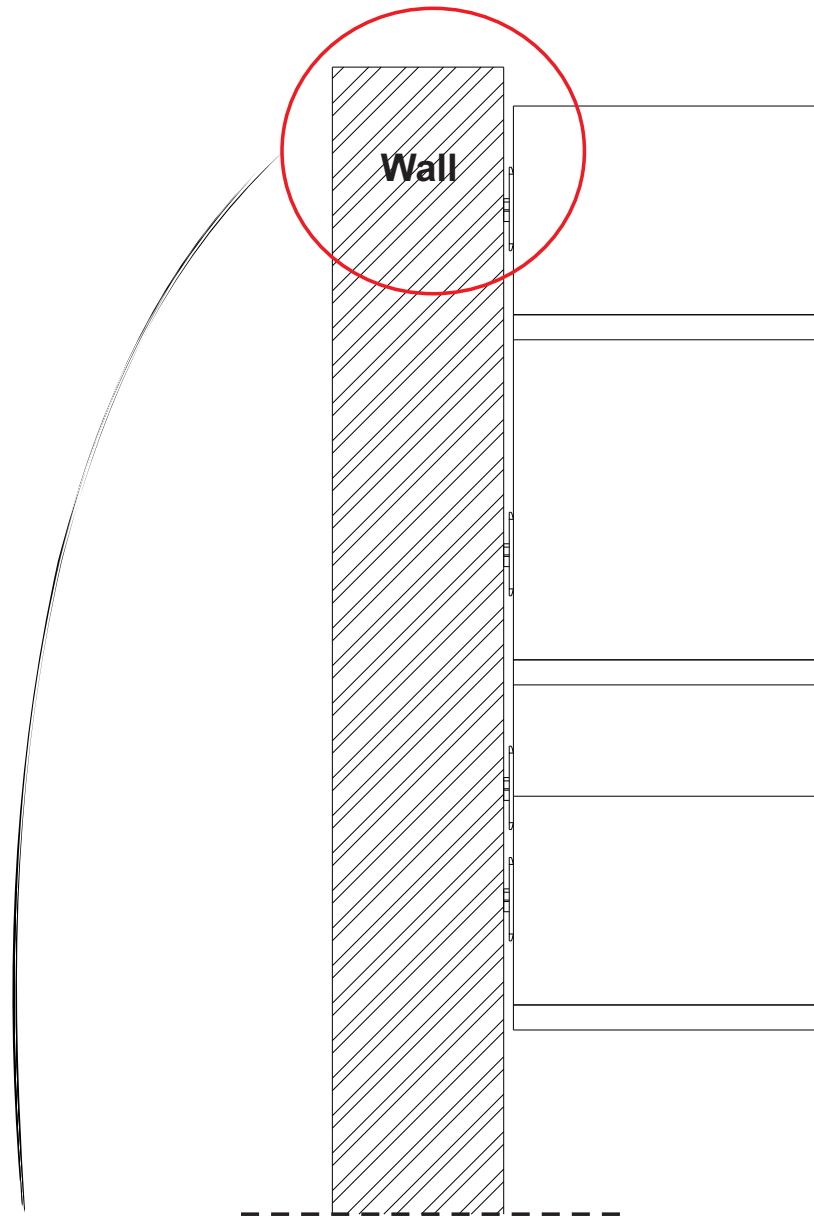

7^{step}

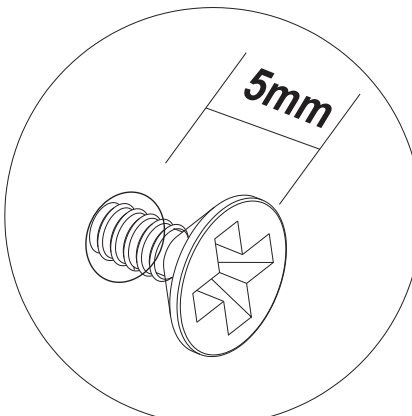
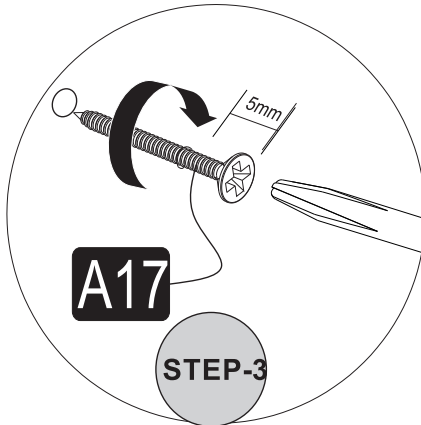
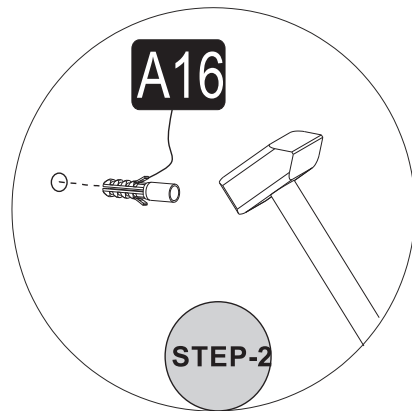
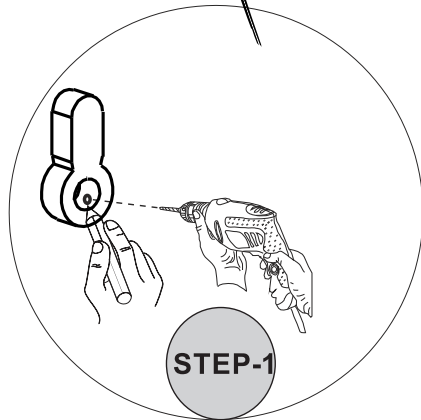
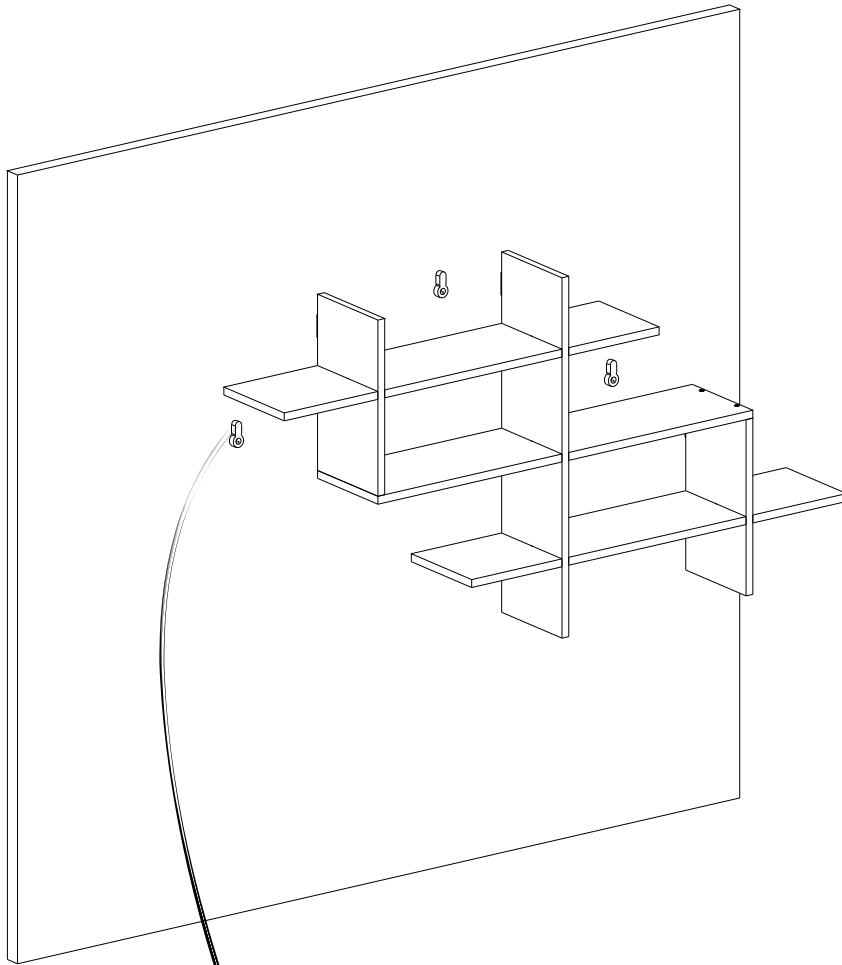

8_{step}

